

PHILIPPINE BIDDING DOCUMENTS

(As Harmonized with Development Partners)

Procurement of INFRASTRUCTURE PROJECTS

Government of the Republic of the Philippines

**PROPOSED REHABILITATION OF ROAD AND DRAINAGE
AT DON PEPE STREET**

20-00092

**Fifth Edition
August 2016**

Preface

These Philippine Bidding Documents (PBDs) for the procurement of Infrastructure Projects (hereinafter referred to also as the “Works”) through Competitive Bidding have been prepared by the Government of the Philippines (GoP) for use by all branches, agencies, departments, bureaus, offices, or instrumentalities of the Government, including government-owned and/or -controlled corporations (GOCCs), government financial institutions (GFIs), state universities and colleges (SUCs), local government units (LGUs), and autonomous regional government. The procedures and practices presented in this document have been developed through broad experience, and are for mandatory¹ use in projects that are financed in whole or in part by the GoP or any foreign government/foreign or international financing institution in accordance with the provisions of the 2016 Revised Implementing Rules and Regulations (IRR) of Republic Act No. 9184 (R. A. 9184).

This PBDs is intended as a model for admeasurements (unit prices or unit rates in a bill of quantities) types of contract, which are the most common in Works contracting.

The Bidding Documents shall clearly and adequately define, among others: (a) the objectives, scope, and expected outputs and/or results of the proposed contract; (b) the eligibility requirements of Bidders; (c) the expected contract duration; and (d) the obligations, duties, and/or functions of the winning bidder.

In order to simplify the preparation of the Bidding Documents for each procurement, the PBDs groups the provisions that are intended to be used unchanged in Section II. Instructions to Bidders (ITB) and in Section IV. General Conditions of Contract (GCC). Data and provisions specific to each procurement and contract should be included in Section III. Bid Data Sheet (BDS); Section V. Special Conditions of Contract (SCC); Section VI. Specifications; Section VII. Drawings; Section VIII. Bill of Quantities; and Section X. Foreign-Assisted Projects. The forms to be used are provided in Section IX. Bidding Forms.

Care should be taken to check the relevance of the provisions of the Bidding Documents against the requirements of the specific Works to be procured. In addition, each section is prepared with notes intended only as information for the Procuring Entity or the person drafting the Bidding Documents. They shall not be included in the final documents, except for the notes introducing Section IX. Bidding Forms, where the information is useful for the Bidder. The following general directions should be observed when using the documents:

- (a) All the documents listed in the Table of Contents are normally required for the procurement of Infrastructure Project. However, they should be adapted as necessary to the circumstances of the particular Project.
- (b) Specific details, such as the “name of the Procuring Entity” and “address for proposal submission,” should be furnished in the BDS and SCC. The final documents should contain neither blank spaces nor options.

¹ Unless the Treaty or International or Executive Agreement expressly provides use of foreign government/foreign or international financing institution procurement guidelines.

- (c) This Preface and the footnotes or notes in italics included in the Invitation to Bid, BDS, SCC, Specifications, Drawings, and Bill of Quantities are not part of the text of the final document, although they contain instructions that the Procuring Entity should strictly follow. The Bidding Documents should contain no footnotes except Section IX. Bidding Forms since these provide important guidance to Bidders.
- (d) The cover should be modified as required to identify the Bidding Documents as to the names of the Project, Contract, and Procuring Entity, in addition to date of issue.
- (e) If modifications must be made to bidding procedures, they can be presented in the BDS. Modifications for specific Project or Contract details should be provided in the SCC as amendments to the Conditions of Contract. For easy completion, whenever reference has to be made to specific clauses in the BDS or SCC these terms shall be printed in bold type face on Section II. Instructions to Bidders, and Section IV. General Conditions of Contract, respectively.

TABLE OF CONTENTS

SECTION I. INVITATION TO BID	5
SECTION II. INSTRUCTIONS TO BIDDERS	6
SECTION III. BID DATA SHEET	36
SECTION IV. GENERAL CONDITIONS OF CONTRACT	37
SECTION V. SPECIAL CONDITIONS OF CONTRACT	70
SECTION VI. SPECIFICATIONS	71
SECTION VII. DRAWINGS	73
SECTION VIII. BILL OF QUANTITIES	74
SECTION IX. BIDDING FORMS	76

Section I. Invitation to Bid

Notes on the Invitation to Bid

The Invitation to Bid provides information that enables potential Bidders to decide whether to participate in the procurement at hand. The Invitation to Bid shall be:

- (a) Posted continuously in the Philippine Government Electronic Procurement System (PhilGEPS) website and the website of the Procuring Entity concerned, if available, and the website prescribed by the foreign government/foreign or international financing institution, if applicable, for seven (7) calendar days starting on the date of advertisement; and
- (b) Posted at any conspicuous place reserved for this purpose in the premises of the Procuring Entity concerned for seven (7) calendar days, as certified by the head of the Bids and Awards Committee (BAC) Secretariat of the Procuring Entity concerned.
- (c) Advertised at least once in a newspaper of general nationwide circulation which has been regularly published for at least two (2) years before the date of issue of the advertisement, subject to Sections 21.2.1(c) of the 2016 Revised IRR of R.A. 9184²;

Apart from the essential items listed in the Bidding Documents, the Invitation to Bid should also indicate the following:

- (a) The date of availability of the Bidding Documents, which shall be from the time the Invitation to Bid is first advertised/posted until the deadline for the submission and receipt of bids.
- (b) The place where the Bidding Documents may be acquired or the website where it may be downloaded.
- (c) The deadline for the submission and receipt of bids from the last day of posting of the Invitation to Bid; and
- (d) Any important bid evaluation criteria.

The Invitation to Bid should be incorporated into the Bidding Documents. The information contained in the Invitation to Bid must conform to the Bidding Documents and in particular to the relevant information in the BDS.

For foreign-assisted projects, the Invitation to Bid to be used is provided in Section X- Foreign-Assisted Projects.

² Two years after the effectivity of the 2016 Revised IRR of RA 9184 on 28 October 2016, advertisement in a newspaper of general nationwide circulation shall no longer be required. However, a Procuring Entity that cannot post its opportunities in the PhilGEPS for justifiable reasons shall continue to publish its advertisements in a newspaper of general nationwide circulation.



REPUBLIC OF THE PHILIPPINES
QUEZON CITY GOVERNMENT



BIDS AND AWARDS COMMITTEE FOR INFRASTRUCTURE & CONSULTANCY
2nd floor, Finance Building, Procurement Department, Quezon City Hall Complex, Elliptical Road, Quezon City

November 18, 2020

INVITATION TO BID

NO.	ITB NO.	PROJECT TITLE	BARANGAY	ABC	DIST	DURATION (CALENDAR DAYS)	SOURCE OF FUND
Building - Small B							
1	20-00074	Proposed Rehabilitation of Electrical System at Bayanihan Elementary School	Paltok	902,845.72	1	30	Special Education Fund
2	20-00075	Proposed Upgrading of Service Entrance at Mines Elementary School	Vasra	1,124,051.39	1	30	Special Education Fund
3	20-00076	Proposed Rehabilitation of Electrical System of E. Rodriguez, Jr. High School	N. S. Amoranto	1,935,569.09	1	60	Special Education Fund
4	20-00077	Proposed Upgrading of Service Entrance at Damong Maliit Elementary School	Nagkaisang Nayon	2,086,210.69	5	90	Special Education Fund
5	20-00078	Proposed Rehabilitation of Electrical System at San Francisco High School	Sto. Cristo	2,121,128.50	1	60	Special Education Fund
18	20-00079	Proposed Improvement of Electrical System of Payatas-B Elementary School	Payatas	2,896,602.19	2	120	Special Education Fund
6	20-00080	Proposed Upgrading of Service Entrance at Aguinaldo Elementary School	San Roque	3,005,006.55	3	90	Special Education Fund
7	20-00081	Proposed Improvement of Bahay Toro Covered Court	Bahay Toro	3,257,786.05	1	60	Engineering Dept Continuing
8	20-00082	Proposed Beautification and Construction of Stage at Lagro Elementary School	Greater Lagro	3,524,485.20	5	90	Special Education Fund
9	20-00083	Proposed Rehabilitation of Elevator System at three (3) storey Multi-Purpose Building	Project 6	3,902,382.75	1	60	Engineering Dept Continuing
10	20-00084	Proposed Installation of Main Electrical Service Entrance of Lucrecia Kasilag Senior High School	Veteran's Village	4,352,970.56	1	120	Special Education Fund
11	20-00085	Proposed Rehabilitation of Electrical System of Commonwealth Elementary School	Commonwealth	5,769,981.99	2	90	Special Education Fund
12	20-00086	Proposed Upgrading of Service Entrance at San Jose Elementary School	San Jose	5,771,893.05	1	90	Special Education Fund
13	20-00087	Proposed Construction of Multi-Purpose Covered Court at GSIS Village	Bahay Toro	6,790,777.25	1	90	Engineering Dept Continuing
14	20-00088	Proposed Rehabilitation of Payatas C Elementary School	Payatas	17,926,394.73	2	150	Special Education Fund
Building - Medium A							
15	20-00089	Proposed Improvement of NEGOTECH Training Center	Tatalon	37,434,085.86	4	240	Engineering Dept Continuing
16	20-00090	Proposed Rehabilitation of Kaligayahan Elementary School	Kaligayahan	44,744,751.71	5	180	Special Education Fund
Flood Control - Small B							
17	20-00091	Proposed Construction of reinforce Concrete Retaining Wall along Tullahan River, Phase 8, North Fairview Subdivision	North Fairview	2,503,955.49	5	90	OCM-20% CDF, Continuing Appro
Roads - Small B							
19	20-00092	Proposed Rehabilitation of Road and Drainage at Don Pepe Street	Sta. Monica	4,598,880.56	5	90	Engineering-Continuing
20	20-00093	Proposed Rehabilitation of Road and Drainage at Ipil Street	Sta. Monica	6,210,346.37	5	120	Engineering-Continuing
21	20-00094	Proposed Rehabilitation of Road and Drainage at Banaba Street	Sta. Monica	8,594,760.26	5	150	Engineering-Continuing

1. The **QUEZON CITY LOCAL GOVERNMENT** now invites bids for Various Projects. Completion of the works is required *as stated above*. Bidders should have completed a contract similar to the Project. The description of an eligible bidder is contained in the Bidding Documents, particularly, in Section II. Instructions to Bidders
2. A complete set of Bidding Documents may be acquired by interested Bidders on **November 19, 2020** upon submission of a Document Request List (DRL) printed from the Philippine Government Electronic Procurement System (PhilGEPS) website from the address below *and upon payment of the applicable fee for the Bidding Documents, pursuant to the latest Guidelines issued by the GPPB.*

STANDARD RATES:

Approved Budget for the Contract	Maximum Cost of Bidding Documents (in Philippine Peso)
More than 500,000 up to 1 Million	1,000.00
More than 1 Million up to 5 Million	5,000.00
More than 5 Million up to 10 Million	10,000.00
More than 10 Million up to 50 Million	25,000.00

It may also be downloaded free of charge from the website of the Philippine Government Electronic Procurement System (PhilGEPS) and the website of the Procuring Entity, provided that Bidders shall pay the applicable fee for the Bidding Documents not later than the submission of the bids.

3. The following are the requirements for purchase of Bidding Documents;
 1. PhilGEPS Registration Certificate (Platinum – 3 Pages)
 2. Document Request List (DRL)
 3. Authorization to purchase bidding documents
 - 3.1 Secretary’s Certificate (for corporation)
 - 3.2 Special Power of Attorney (for sole proprietorship)
 4. Notarized Joint Venture Agreement (if applicable)
 5. Letter of Intent

It must be duly received by the BAC Secretariat at 2nd Floor, Procurement Department, Finance Building, Quezon City Hall Compound on or before **November 26, 2020 - 5:00PM**

4. The **QC- BAC- INFRASTRUCTURE & CONSULTANCY** will hold a Pre-Bid Conference on **December 02, 2020 at 10:00 AM at 2nd Floor, Procurement Department-Bidding Room, Finance Building, Quezon City Hall Compound** or we encourage the prospective bidders to join through our **Virtual Conference (ZOOM APP)**
Meeting ID: 89111859539
Password : 598996
5. Bids must be duly received by the BAC Secretariat at the address below on or before **December 14, 2020 – 9:00AM**. All Bids must be accompanied by a bid security in any of the acceptable forms and in the amount stated in **ITB** Clause.

Bid opening will be on **December 14, 2020 - 10:00AM at 2nd Floor, Procurement Department-Bidding Room, Finance Building, Quezon City Hall Compound**. Bids will be opened in the presence of the bidders’ representatives who choose to attend at the address below. Late bids shall not be accepted.

6. The **Quezon City Local Government** reserves the right to reject any and all bids, declare a failure of bidding, or not award the contract at any time prior to contract award in accordance with Section 41 of RA 9184 and its IRR, without thereby incurring any liability to the affected bidder or bidders.

7. For further information, please refer to:

ATTY. DOMINIC B. GARCIA
OIC, Procurement Department
2nd Floor, Procurement Department,
Finance Building, Quezon City Hall Compound
Elliptical Road, Barangay Central Diliman, Quezon City.
Tel. No. (02)8988-4242 loc. 8506/8710
Email Add: procurement@quezoncity.gov.ph
Website: www.quezoncity.gov.ph

By:

ATTY. MARK DALE DIAMOND P. PERRAL
Chairman BAC-Infra and Consultancy

Section II. Instructions to Bidders

Notes on the Instructions to Bidders

This Section of the Bidding Documents provides the information necessary for Bidders to prepare responsive bids, in accordance with the requirements of the Procuring Entity. It also provides information on the bid submission, eligibility check, opening and evaluation of bids, and on the award of contract.

This Section also contains provisions that are to be used unchanged. Section III. Bid Data Sheet consists of provisions that supplement, amend, or specify in detail information or requirements included in this Section and which are specific to each procurement.

Matters governing the performance of the Contractor, payments under the contract, or matters affecting the risks, rights, and obligations of the parties under the contract are not normally included in this Section, but rather under Section IV. General Conditions of Contract (GCC), and/or Section V. Special Conditions of Contract (SCC). If duplication of a subject is inevitable in the other sections of the document prepared by the Procuring Entity, care must be exercised to avoid contradictions between clauses dealing with the same matter.

TABLE OF CONTENTS

A. GENERAL.....	9
1. Scope of Bid.....	9
2. Source of Funds.....	9
3. Corrupt, Fraudulent, Collusive, Coercive, and Obstructive Practices	9
4. Conflict of Interest	11
5. Eligible Bidders.....	12
6. Bidder’s Responsibilities	13
7. Origin of GOODS and Services.....	16
8. Subcontracts	16
B. CONTENTS OF BIDDING DOCUMENTS	16
9. Pre-Bid Conference.....	16
10. Clarification and Amendment of Bidding Documents.....	17
C. PREPARATION OF BIDS	17
11. Language of Bids	17
12. Documents Comprising the Bid: Eligibility and Technical Components.....	18
13. Documents Comprising the Bid: Financial Component	20
14. Alternative Bids	21
15. Bid Prices	21
16. Bid Currencies.....	22
17. Bid Validity.....	22
18. Bid Security.....	22
19. Format and Signing of Bids	25
20. Sealing and Marking of Bids.....	25
D. SUBMISSION AND OPENING OF BIDS	26
21. Deadline for Submission of Bids	26
22. Late Bids	26
23. Modification and Withdrawal of Bids.....	26
24. Opening and Preliminary Examination of Bids	27
E. EVALUATION AND COMPARISON OF BIDS.....	29
25. Process to be Confidential.....	29
26. Clarification of Bids.....	29
27. Detailed Evaluation and Comparison of Bids.....	29
28. Post Qualification.....	30

29.	Reservation Clause.....	31
F.	AWARD OF CONTRACT	32
30.	Contract Award	32
31.	Signing of the Contract	33
32.	Performance Security	34
33.	Notice to Proceed	35
34.	Protest Mechanism.....	35

A. General

1. Scope of Bid

- 1.1. The Procuring Entity named in the **BDS**, invites bids for the construction of Works, as described in Section VI. Specifications.
- 1.2. The name, identification, and number of lots specific to this bidding are provided in the **BDS**. The contracting strategy and basis of evaluation of lots is described in **ITB** Clause 27.
- 1.3. The successful Bidder will be expected to complete the Works by the intended completion date specified in **SCC** Clause 1.17.

2. Source of Funds

The Procuring Entity has a budget or received funds from the Funding Source named in the **BDS**, and in the amount indicated in the **BDS**. It intends to apply part of the funds received for the Project, as defined in the **BDS**, to cover eligible payments under the Contract for the Works.

3. Corrupt, Fraudulent, Collusive, Coercive, and Obstructive Practices

- 3.1. Unless otherwise specified in the **BDS**, the Procuring Entity, as well as bidders and contractors, shall observe the highest standard of ethics during the procurement and execution of the contract. In pursuance of this policy, the Funding Source:
 - (a) defines, for purposes of this provision, the terms set forth below as follows:
 - (i) "corrupt practice" means behavior on the part of officials in the public or private sectors by which they improperly and unlawfully enrich themselves, others, or induce others to do so, by misusing the position in which they are placed, and includes the offering, giving, receiving, or soliciting of anything of value to influence the action of any such official in the procurement process or in contract execution; entering, on behalf of the Procuring Entity, into any contract or transaction manifestly and grossly disadvantageous to the same, whether or not the public officer profited or will profit thereby, and similar acts as provided in Republic Act 3019;
 - (ii) "fraudulent practice" means a misrepresentation of facts in order to influence a procurement process or the execution of a contract to the detriment of the Procuring Entity, and includes collusive practices among Bidders (prior to or after Bid submission) designed to establish bid prices at artificial, non-competitive levels and to deprive the Procuring Entity of the benefits of free and open competition;

- (iii) “collusive practices” means a scheme or arrangement between two or more Bidders, with or without the knowledge of the Procuring Entity, designed to establish bid prices at artificial, non-competitive levels; and
 - (iv) “coercive practices” means harming or threatening to harm, directly or indirectly, persons, or their property to influence their participation in a procurement process, or affect the execution of a contract;
 - (v) “obstructive practice” is
 - (aa) deliberately destroying, falsifying, altering or concealing of evidence material to an administrative proceedings or investigation or making false statements to investigators in order to materially impede an administrative proceedings or investigation of the Procuring Entity or any foreign government/foreign or international financing institution into allegations of a corrupt, fraudulent, coercive or collusive practice; and/or threatening, harassing or intimidating any party to prevent it from disclosing its knowledge of matters relevant to the administrative proceedings or investigation or from pursuing such proceedings or investigation; or
 - (bb) acts intended to materially impede the exercise of the inspection and audit rights of the Procuring Entity or any foreign government/foreign or international financing institution herein.
 - (b) will reject a proposal for award if it determines that the Bidder recommended for award has engaged in corrupt or fraudulent practices in competing for the Contract; and
 - (c) will declare a firm ineligible, either indefinitely or for a stated period of time, to be awarded Contract funded by the Funding Source if it at any time determines that the firm has engaged in corrupt or fraudulent practices in competing or, or in executing, a Contract funded by the Funding Source.
- 3.2. Further, the Procuring Entity will seek to impose the maximum civil, administrative, and/or criminal penalties available under the applicable laws on individuals and organizations deemed to be involved in any of the practices mentioned in **ITB** Clause 3.1(a).
- 3.3. Furthermore, the Funding Source and the Procuring Entity reserve the right to inspect and audit records and accounts of a contractor in the bidding for and performance of a contract themselves or through independent auditors as reflected in the **GCC** Clause 34.

4. Conflict of Interest

- 4.1. All Bidders found to have conflicting interests shall be disqualified to participate in the procurement at hand, without prejudice to the imposition of appropriate administrative, civil, and criminal sanctions. A Bidder may be considered to have conflicting interests with another Bidder in any of the events described in paragraphs (a) through (c) and a general conflict of interest in any of the circumstances set out in paragraphs (d) through (g) below:
- (a) A Bidder has controlling shareholders in common with another Bidder;
 - (b) A Bidder receives or has received any direct or indirect subsidy from any other Bidder;
 - (c) A Bidder has the same legal representative as that of another Bidder for purposes of this Bid;
 - (d) A Bidder has a relationship, directly or through third parties, that puts them in a position to have access to information about or influence on the bid of another Bidder or influence the decisions of the Procuring Entity regarding this bidding process;
 - (e) A Bidder submits more than one bid in this bidding process. However, this does not limit the participation of subcontractors in more than one bid;
 - (f) A Bidder who participated as a consultant in the preparation of the design or technical specifications of the goods and related services that are the subject of the bid; or
 - (g) A Bidder who lends, or temporarily seconds, its personnel to firms or organizations which are engaged in consulting services for the preparation related to procurement for or implementation of the project, if the personnel would be involved in any capacity on the same project.
- 4.2. In accordance with Section 47 of the IRR of RA 9184, all Bidding Documents shall be accompanied by a sworn affidavit of the Bidder that it is not related to the Head of the Procuring Entity (HoPE), members of the Bids and Awards Committee (BAC), members of the Technical Working Group (TWG), members of the BAC Secretariat, the head of the Project Management Office (PMO) or the end-user unit, and the project consultants, by consanguinity or affinity up to the third civil degree. On the part of the Bidder, this Clause shall apply to the following persons:
- (a) If the Bidder is an individual or a sole proprietorship, to the Bidder himself;
 - (b) If the Bidder is a partnership, to all its officers and members;

- (c) If the Bidder is a corporation, to all its officers, directors, and controlling stockholders;
- (d) If the Bidder is a cooperative, to all its officers, directors, and controlling shareholders or members; and
- (e) If the Bidder is a joint venture (JV), the provisions of items (a), (b), (c) or (d) of this Clause shall correspondingly apply to each of the members of the said JV, as may be appropriate.

Relationship of the nature described above or failure to comply with this Clause will result in the automatic disqualification of a Bidder.

5. Eligible Bidders

- 5.1. Unless otherwise indicated in the **BDS**, the following persons shall be eligible to participate in this Bidding:
- (a) Duly licensed Filipino citizens/sole proprietorships;
 - (b) Partnerships duly organized under the laws of the Philippines and of which at least seventy five percent (75%) of the interest belongs to citizens of the Philippines;
 - (c) Corporations duly organized under the laws of the Philippines, and of which at least seventy five percent (75%) of the outstanding capital stock belongs to citizens of the Philippines;
 - (d) Cooperatives duly organized under the laws of the Philippines.
 - (e) Persons/entities forming themselves into a JV, i.e., a group of two (2) or more persons/entities that intend to be jointly and severally responsible or liable for a particular contract: Provided, however, that, in accordance with Letter of Instructions No. 630, Filipino ownership or interest of the joint venture concerned shall be at least seventy five percent (75%): Provided, further, that joint ventures in which Filipino ownership or interest is less than seventy five percent (75%) may be eligible where the structures to be built require the application of techniques and/or technologies which are not adequately possessed by a person/entity meeting the seventy five percent (75%) Filipino ownership requirement: Provided, finally, that in the latter case, Filipino ownership or interest shall not be less than twenty five percent (25%). For this purpose, Filipino ownership or interest shall be based on the contributions of each of the members of the joint venture as specified in their JVA.
- 5.2. The Procuring Entity may also invite foreign bidders when provided for under any Treaty or International or Executive Agreement as specified in the **BDS**.
- 5.3. Government owned or controlled corporations (GOCCs) may be eligible to participate only if they can establish that they (a) are legally and financially

autonomous, (b) operate under commercial law, and (c) are not attached agencies of the Procuring Entity.

- 5.4. (a) The Bidder must have an experience of having completed a Single Largest Completed Contract (SLCC) that is similar to this Project, equivalent to at least fifty percent (50%) of the ABC adjusted, if necessary, by the Bidder to current prices using the Philippine Statistics Authority (PSA) consumer price index. However, contractors under Small A and Small B categories without similar experience on the contract to be bid may be allowed to bid if the cost of such contract is not more than the Allowable Range of Contract Cost (ARCC) of their registration based on the guidelines as prescribed by the PCAB.

(b) For Foreign-funded Procurement, the Procuring Entity and the foreign government/foreign or international financing institution may agree on another track record requirement, as specified in the **BDS**.

For this purpose, contracts similar to the Project shall be those described in the **BDS**.

- 5.5. The Bidder must submit a computation of its Net Financial Contracting Capacity (NFCC), which must be at least equal to the ABC to be bid, calculated as follows:

NFCC = [(Current assets minus current liabilities) (15)] minus the value of all outstanding or uncompleted portions of the projects under ongoing contracts, including awarded contracts yet to be started coinciding with the contract for this Project.

The values of the domestic bidder's current assets and current liabilities shall be based on the latest Audited Financial Statements (AFS) submitted to the BIR.

For purposes of computing the foreign bidders' NFCC, the value of the current assets and current liabilities shall be based on their audited financial statements prepared in accordance with international financial reporting standards.

6. Bidder's Responsibilities

- 6.1. The Bidder or its duly authorized representative shall submit a sworn statement in the form prescribed in Section IX. Bidding Forms as required in **ITB** Clause 12.1(b)(iii).

- 6.2. The Bidder is responsible for the following:

- (a) Having taken steps to carefully examine all of the Bidding Documents;
- (b) Having acknowledged all conditions, local or otherwise, affecting the implementation of the contract;

- (c) Having made an estimate of the facilities available and needed for the contract to be bid, if any;
- (d) Having complied with its responsibility to inquire or secure Supplemental/Bid Bulletin/s as provided under **ITB** Clause 10.4.
- (e) Ensuring that it is not “blacklisted” or barred from bidding by the GoP or any of its agencies, offices, corporations, or LGUs, including foreign government/foreign or international financing institution whose blacklisting rules have been recognized by the GPPB;
- (f) Ensuring that each of the documents submitted in satisfaction of the bidding requirements is an authentic copy of the original, complete, and all statements and information provided therein are true and correct;
- (g) Authorizing the HoPE or its duly authorized representative/s to verify all the documents submitted;
- (h) Ensuring that the signatory is the duly authorized representative of the Bidder, and granted full power and authority to do, execute and perform any and all acts necessary to participate, submit the bid, and to sign and execute the ensuing contract, accompanied by the duly notarized Special Power of Attorney, Board/Partnership Resolution, or Secretary’s Certificate, whichever is applicable;
- (i) Complying with the disclosure provision under Section 47 of RA 9184 and its IRR in relation to other provisions of RA 3019;
- (j) Complying with existing labor laws and standards, in the case of procurement of services. Moreover, bidder undertakes to:
 - (i) Ensure the entitlement of workers to wages, hours of work, safety and health and other prevailing conditions of work as established by national laws, rules and regulations; or collective bargaining agreement; or arbitration award, if and when applicable.

In case there is a finding by the Procuring Entity or the DOLE of underpayment or non-payment of workers’ wage and wage-related benefits, bidder agrees that the performance security or portion of the contract amount shall be withheld in favor of the complaining workers pursuant to appropriate provisions of Republic Act No. 9184 without prejudice to the institution of appropriate actions under the Labor Code, as amended, and other social legislations.

- (ii) Comply with occupational safety and health standards and to correct deficiencies, if any.

In case of imminent danger, injury or death of the worker, bidder undertakes to suspend contract implementation pending clearance to proceed from the DOLE Regional Office and to comply with Work Stoppage Order; and

- (iii) Inform the workers of their conditions of work, labor clauses under the contract specifying wages, hours of work and other benefits under prevailing national laws, rules and regulations; or collective bargaining agreement; or arbitration award, if and when applicable, through posting in two (2) conspicuous places in the establishment's premises; and
- (k) Ensuring that it did not give or pay, directly or indirectly, any commission, amount, fee, or any form of consideration, pecuniary or otherwise, to any person or official, personnel or representative of the;

Failure to observe any of the above responsibilities shall be at the risk of the Bidder concerned.

- 6.3. The Bidder, by the act of submitting its bid, shall be deemed to have inspected the site, determined the general characteristics of the contract works and the conditions for this Project and examine all instructions, forms, terms, and project requirements in the Bidding Documents.
- 6.4. It shall be the sole responsibility of the prospective bidder to determine and to satisfy itself by such means as it considers necessary or desirable as to all matters pertaining to this Project, including: (a) the location and the nature of the contract, project, or work; (b) climatic conditions; (c) transportation facilities; (c) nature and condition of the terrain, geological conditions at the site communication facilities, requirements, location and availability of construction aggregates and other materials, labor, water, electric power and access roads; and (d) other factors that may affect the cost, duration and execution or implementation of the contract, project, or work.
- 6.5. The Procuring Entity shall not assume any responsibility regarding erroneous interpretations or conclusions by the prospective or eligible bidder out of the data furnished by the procuring entity. However, the Procuring Entity shall ensure that all information in the Bidding Documents, including supplemental/bid bulletins issued are correct and consistent.
- 6.6. Before submitting their bids, the Bidders are deemed to have become familiar with all existing laws, decrees, ordinances, acts and regulations of the Philippines which may affect the contract in any way.
- 6.7. The Bidder shall bear all costs associated with the preparation and submission of his bid, and the Procuring Entity will in no case be responsible or liable for those costs, regardless of the conduct or outcome of the bidding process.
- 6.8. The Bidder should note that the Procuring Entity will accept bids only from those that have paid the applicable fee for the Bidding Documents at the office indicated in the Invitation to Bid.

7. Origin of Goods and Services

There is no restriction on the origin of Goods, or Contracting of Works or Services other than those prohibited by a decision of the United Nations Security Council taken under Chapter VII of the Charter of the United Nations.

8. Subcontracts

- 8.1. Unless otherwise specified in the **BDS**, the Bidder may subcontract portions of the Works to an extent as may be approved by the Procuring Entity and stated in the **BDS**. However, subcontracting of any portion shall not relieve the Bidder from any liability or obligation that may arise from the contract for this Project.
- 8.2. Subcontractors must submit the documentary requirements under **ITB** Clause 12 and comply with the eligibility criteria specified in the **BDS**. In the event that any subcontractor is found by the Procuring Entity to be ineligible, the subcontracting of such portion of the Works shall be disallowed.
- 8.3. The Bidder may identify the subcontractor to whom a portion of the Works will be subcontracted at any stage of the bidding process or during contract implementation. If the Bidder opts to disclose the name of the subcontractor during bid submission, the Bidder shall include the required documents as part of the technical component of its bid.

B. Contents of Bidding Documents

9. Pre-Bid Conference

- 9.1. (a) If so specified in the **BDS**, a pre-bid conference shall be held at the venue and on the date indicated therein, to clarify and address the Bidders' questions on the technical and financial components of this Project.

(b) The pre-bid conference shall be held at least twelve (12) calendar days before the deadline for the submission of and receipt of bids, but not earlier than seven (7) calendar days from the posting of the Invitation to Bid/Bidding Documents in the PhilGEPS website. If the Procuring Entity determines that, by reason of the method, nature, or complexity of the contract to be bid, or when international participation will be more advantageous to the GoP, a longer period for the preparation of bids is necessary, the pre-bid conference shall be held at least thirty (30) calendar days before the deadline for the submission and receipt of bids, as specified in the **BDS**.
- 9.2. Bidders are encouraged to attend the pre-bid conference to ensure that they fully understand the Procuring Entity's requirements. Non-attendance of the Bidder will in no way prejudice its bid; however, the Bidder is expected to know the changes and/or amendments to the Bidding Documents as recorded in the minutes of the pre-bid conference and the Supplemental/Bid Bulletin. The minutes of the pre-bid conference shall be recorded and prepared not later than five (5) calendar days after the pre-bid conference. The minutes shall be

made available to prospective bidders not later than five (5) days upon written request.

- 9.3. Decisions of the BAC amending any provision of the bidding documents shall be issued in writing through a Supplemental/Bid Bulletin at least seven (7) calendar days before the deadline for the submission and receipt of bids.

10. Clarification and Amendment of Bidding Documents

- 10.1. Prospective bidders may request for clarification(s) on and/or interpretation of any part of the Bidding Documents. Such a request must be in writing and submitted to the Procuring Entity at the address indicated in the **BDS** at least ten (10) calendar days before the deadline set for the submission and receipt of Bids.
- 10.2. The BAC shall respond to the said request by issuing a Supplemental/Bid Bulletin, to be made available to all those who have properly secured the Bidding Documents, at least seven (7) calendar days before the deadline for the submission and receipt of Bids.
- 10.3. Supplemental/Bid Bulletins may also be issued upon the Procuring Entity's initiative for purposes of clarifying or modifying any provision of the Bidding Documents not later than seven (7) calendar days before the deadline for the submission and receipt of Bids. Any modification to the Bidding Documents shall be identified as an amendment.
- 10.4. Any Supplemental/Bid Bulletin issued by the BAC shall also be posted in the PhilGEPS and the website of the Procuring Entity concerned, if available, and at any conspicuous place in the premises of the Procuring Entity concerned. It shall be the responsibility of all Bidders who have properly secured the Bidding Documents to inquire and secure Supplemental/Bid Bulletins that may be issued by the BAC. However, Bidders who have submitted bids before the issuance of the Supplemental/Bid Bulletin must be informed and allowed to modify or withdraw their bids in accordance with **ITB** Clause 23.

C. Preparation of Bids

11. Language of Bids

The eligibility requirements or statements, the bids, and all other documents to be submitted to the BAC must be in English. If the eligibility requirements or statements, the bids, and all other documents submitted to the BAC are in foreign language other than English, it must be accompanied by a translation of the documents in English. The documents shall be translated by the relevant foreign government agency, the foreign government agency authorized to translate documents, or a registered translator in the foreign bidder's country; and shall be authenticated by the appropriate Philippine foreign service establishment/post or the equivalent office having jurisdiction over the foreign bidder's affairs in the Philippines. The English translation shall govern, for purposes of interpretation of the bid.

12. Documents Comprising the Bid: Eligibility and Technical Components

12.1. Unless otherwise indicated in the **BDS**, the first envelope shall contain the following eligibility and technical documents:

(a) Eligibility Documents –

Class “A” Documents

- (i) PhilGEPS Certificate of Registration and Membership in accordance with Section 8.5.2 of the IRR, except for foreign bidders participating in the procurement by a Philippine Foreign Service Office or Post, which shall submit their eligibility documents under Section 23.1 of the IRR, provided, that the winning bidder shall register with the PhilGEPS in accordance with Section 37.1.4 of the IRR;
- (ii) Statement of all its ongoing government and private contracts, including contracts awarded but not yet started, if any, whether similar or not similar in nature and complexity to the contract to be bid; and

Statement of the Bidder’s SLCC similar to the contract to be bid, in accordance with ITB Clause 5.4.

The two statements required shall indicate for each contract the following:

- (ii.1) name of the contract;
- (ii.2) date of the contract;
- (ii.3) contract duration;
- (ii.4) owner’s name and address;
- (ii.5) nature of work;
- (ii.6) contractor’s role (whether sole contractor, subcontractor, or partner in a JV) and percentage of participation;
- (ii.7) total contract value at award;
- (ii.8) date of completion or estimated completion time;
- (ii.9) total contract value at completion, if applicable;
- (ii.10) percentages of planned and actual accomplishments, if applicable; and

(ii.11) value of outstanding works, if applicable.

The statement of the Bidder's SLCC shall be supported by the Notice of Award and/or Notice to Proceed, Project Owner's Certificate of Final Acceptance issued by the Owner other than the Contractor or the Constructors Performance Evaluation System (CPES) Final Rating, which must be at least satisfactory. In case of contracts with the private sector, an equivalent document shall be submitted;

- (iii) Unless otherwise provided in the **BDS**, a valid special PCAB License in case of joint ventures, and registration for the type and cost of the contract for this Project; and
- (iv) NFCC computation in accordance with ITB Clause 5.5.

Class "B" Documents

(v) If applicable, Joint Venture Agreement (JVA) in accordance with RA 4566.

(b) Technical Documents –

- (i) Bid security in accordance with **ITB** Clause 18. If the Bidder opts to submit the bid security in the form of:
 - (i.1) a bank draft/guarantee or an irrevocable letter of credit issued by a foreign bank, it shall be accompanied by a confirmation from a Universal or Commercial Bank; or
 - (i.2) a surety bond accompanied by a certification coming from the Insurance Commission that the surety or insurance company is authorized to issue such instruments.
- (ii) Project Requirements, which shall include the following:
 - (ii.1) Organizational chart for the contract to be bid;
 - (ii.2) List of contractor's personnel (*e.g.*, Project Manager, Project Engineers, Materials Engineers, and Foremen), to be assigned to the contract to be bid, with their complete qualification and experience data. These personnel must meet the required minimum years of experience set in the **BDS**; and
 - (ii.3) List of contractor's major equipment units, which are owned, leased, and/or under purchase agreements, supported by proof of ownership, certification of availability of equipment from the equipment lessor/vendor for the duration of the project, as the case

may be, which must meet the minimum requirements for the contract set in the **BDS**; and

- (iii) Sworn statement in accordance with Section 25.3 of the IRR of RA 9184 and using the form prescribed in Section IX. Bidding Forms.

13. Documents Comprising the Bid: Financial Component

13.1. Unless otherwise stated in the **BDS**, the financial component of the bid shall contain the following:

- (a) Financial Bid Form, which includes bid prices and the bill of quantities, in accordance with **ITB** Clauses 15.1 and 15.3; and
- (b) Any other document related to the financial component of the bid as stated in the **BDS**.

13.2. (a) Unless otherwise stated in the **BDS**, all Bids that exceed the ABC shall not be accepted.

- (b) Unless otherwise indicated in the **BDS**, for foreign-funded procurement, a ceiling may be applied to bid prices provided the following conditions are met:

- (i) Bidding Documents are obtainable free of charge on a freely accessible website. If payment of Bidding Documents is required by the procuring entity, payment could be made upon the submission of bids.
- (ii) The procuring entity has procedures in place to ensure that the ABC is based on recent estimates made by the engineer or the responsible unit of the procuring entity and that the estimates are based on adequate detailed engineering (in the case of infrastructure projects) and reflect the quality, supervision and risk and inflationary factors, as well as prevailing market prices, associated with the types of works or goods to be procured.
- (iii) The procuring entity has trained cost estimators on estimating prices and analyzing bid variances. In the case of infrastructure projects, the procuring entity must also have trained quantity surveyors.
- (iv) The procuring entity has established a system to monitor and report bid prices relative to ABC and engineer's/procuring entity's estimate.
- (v) The procuring entity has established a monitoring and evaluation system for contract implementation to provide a feedback on actual total costs of goods and works.

14. Alternative Bids

- 14.1. Alternative Bids shall be rejected. For this purpose, alternative bid is an offer made by a Bidder in addition or as a substitute to its original bid which may be included as part of its original bid or submitted separately therewith for purposes of bidding. A bid with options is considered an alternative bid regardless of whether said bid proposal is contained in a single envelope or submitted in two (2) or more separate bid envelopes.
- 14.2. Bidders shall submit offers that comply with the requirements of the Bidding Documents, including the basic technical design as indicated in the drawings and specifications. Unless there is a value engineering clause in the **BDS**, alternative bids shall not be accepted.
- 14.3. Each Bidder shall submit only one Bid, either individually or as a partner in a JV. A Bidder who submits or participates in more than one bid (other than as a subcontractor if a subcontractor is permitted to participate in more than one bid) will cause all the proposals with the Bidder's participation to be disqualified. This shall be without prejudice to any applicable criminal, civil and administrative penalties that may be imposed upon the persons and entities concerned.

15. Bid Prices

- 15.1. The contract shall be for the whole Works, as described in **ITB** Clause 1.1, based on the priced Bill of Quantities submitted by the Bidder.
- 15.2. The Bidder shall fill in rates and prices for all items of the Works described in the Bill of Quantities. Bids not addressing or providing all of the required items in the Bidding Documents including, where applicable, Bill of Quantities, shall be considered non-responsive and, thus, automatically disqualified. In this regard, where a required item is provided, but no price is indicated, the same shall be considered as non-responsive, but specifying a zero (0) or a dash (-) for the said item would mean that it is being offered for free to the Government, except those required by law or regulations to be provided for.
- 15.3. All duties, taxes, and other levies payable by the Contractor under the Contract, or for any other cause, prior to the deadline for submission of bids, shall be included in the rates, prices, and total bid price submitted by the Bidder.
- 15.4. All bid prices for the given scope of work in the contract as awarded shall be considered as fixed prices, and therefore not subject to price escalation during contract implementation, except under extraordinary circumstances as specified in GCC Clause 48. Upon the recommendation of the Procuring Entity, price escalation may be allowed in extraordinary circumstances as may be determined by the National Economic and Development Authority in accordance with the Civil Code of the Philippines, and upon approval by the GPPB. Furthermore, in cases where the cost of the awarded contract is affected by any applicable new laws, ordinances, regulations, or other acts of

the GoP, promulgated after the date of bid opening, a contract price adjustment shall be made or appropriate relief shall be applied on a no loss-no gain basis.

16. Bid Currencies

- 16.1. All bid prices shall be quoted in Philippine Pesos unless otherwise provided in the **BDS**. However, for purposes of bid evaluation, bids denominated in foreign currencies shall be converted to Philippine currency based on the exchange rate prevailing on the day of the Bid Opening.
- 16.2. If so allowed in accordance with **ITB** Clause 16.1, the Procuring Entity for purposes of bid evaluation and comparing the bid prices will convert the amounts in various currencies in which the bid price is expressed to Philippine Pesos at the exchange rate as published in the *Bangko Sentral ng Pilipinas* (BSP) reference rate bulletin on the day of the bid opening.
- 16.3. Unless otherwise specified in the **BDS**, payment of the contract price shall be made in Philippine Pesos.

17. Bid Validity

- 17.1. Bids shall remain valid for the period specified in the **BDS** which shall not exceed one hundred twenty (120) calendar days from the date of the opening of bids.
- 17.2. In exceptional circumstances, prior to the expiration of the bid validity period, the Procuring Entity may request Bidders to extend the period of validity of their bids. The request and the responses shall be made in writing. The bid security described in **ITB** Clause 18 should also be extended corresponding to the extension of the bid validity period at the least. A Bidder may refuse the request without forfeiting its bid security, but his bid shall no longer be considered for further evaluation and award. A Bidder granting the request shall not be required or permitted to modify its bid.

18. Bid Security

- 18.1. The Bidder shall submit a Bid Securing Declaration or any form of Bid Security in an amount stated in the **BDS**, which shall be not less than the percentage of the ABC in accordance with the following schedule:

Form of Bid Security	Amount of Bid Security (Not less than the Percentage of the ABC)
(a) Cash or cashier's/manager's check issued by a Universal or Commercial Bank. <i>For biddings conducted by LGUs, the cashier's/manager's check may be issued by other</i>	Two percent (2%)

<p><i>banks certified by the BSP as authorized to issue such financial instrument.</i></p>	
<p>(b) Bank draft/guarantee or irrevocable letter of credit issued by a Universal or Commercial Bank: Provided, however, that it shall be confirmed or authenticated by a Universal or Commercial Bank, if issued by a foreign bank.</p> <p><i>For biddings conducted by LGUs, the Bank Draft/Guarantee, or irrevocable letter of credit may be issued by other banks certified by the BSP as authorized to issue such financial instrument.</i></p>	
<p>(c) Surety bond callable upon demand issued by a surety or insurance company duly certified by the Insurance Commission as authorized to issue such security; and/or</p>	<p>Five percent (5%)</p>

The Bid Securing Declaration mentioned above is an undertaking which states, among others, that the Bidder shall enter into contract with the procuring entity and furnish the performance security required under ITB Clause 32.2, within ten (10) calendar days from receipt of the Notice of Award, and commits to pay the corresponding amount as fine, and be suspended for a period of time from being qualified to participate in any government procurement activity in the event it violates any of the conditions stated therein as provided in the guidelines issued by the GPPB.

- 18.2. The bid security should be valid for the period specified in the **BDS**. Any bid not accompanied by an acceptable bid security shall be rejected by the Procuring Entity as non-responsive.
- 18.3. No bid securities shall be returned to Bidders after the opening of bids and before contract signing, except to those that failed or declared as post-disqualified, upon submission of a written waiver of their right to file a request for reconsideration and/or protest, or lapse of the reglementary period without having filed a request for reconsideration or protest. Without prejudice on its forfeiture, Bid Securities shall be returned only after the Bidder with the Lowest Calculated Responsive Bid (LCRB) has signed the contract and furnished the Performance Security, but in no case later than the expiration of the Bid Security validity period indicated in **ITB** Clause 18.2.

18.4. Upon signing and execution of the contract, pursuant to **ITB** Clause 31, and the posting of the performance security, pursuant to **ITB** Clause 32, the successful Bidder's Bid Security will be discharged, but in no case later than the Bid Security validity period as indicated in **ITB** Clause 18.2.

18.5. The bid security may be forfeited:

(a) if a Bidder:

- (i) withdraws its bid during the period of bid validity specified in **ITB** Clause 17;
- (ii) does not accept the correction of errors pursuant to **ITB** Clause 27.3(b);
- (iii) has a finding against the veracity of the required documents submitted in accordance with **ITB** Clause 28.2;
- (iv) submission of eligibility requirements containing false information or falsified documents;
- (v) submission of bids that contain false information or falsified documents, or the concealment of such information in the bids in order to influence the outcome of eligibility screening or any other stage of the public bidding;
- (vi) allowing the use of one's name, or using the name of another for purposes of public bidding;
- (vii) withdrawal of a bid, or refusal to accept an award, or enter into contract with the Government without justifiable cause, after the Bidder had been adjudged as having submitted the LCRB;
- (viii) refusal or failure to post the required performance security within the prescribed time;
- (ix) refusal to clarify or validate in writing its bid during post-qualification within a period of seven (7) calendar days from receipt of the request for clarification;
- (x) any documented attempt by a Bidder to unduly influence the outcome of the bidding in his favor;
- (xi) failure of the potential joint venture partners to enter into the joint venture after the bid is declared successful; or
- (xii) all other acts that tend to defeat the purpose of the competitive bidding, such as habitually withdrawing from bidding, submitting late Bids or patently insufficient bid, for at least three (3) times within a year, except for valid reasons.

(b) if the successful Bidder:

- (i) fails to sign the contract in accordance with **ITB** Clause 31;
- (ii) fails to furnish performance security in accordance with **ITB** Clause 32.

19. Format and Signing of Bids

- 19.1 Bidders shall submit their bids through their duly authorized representative using the appropriate forms provided in Section IX. Bidding Forms on or before the deadline specified in the **ITB** Clause 21 in two (2) separate sealed bid envelopes, and which shall be submitted simultaneously. The first shall contain the technical component of the bid, including the eligibility requirements under **ITB** Clause 12.1, and the second shall contain the financial component of the bid. This shall also be observed for each lot in the case of lot procurement.
- 19.2 Forms as mentioned in **ITB** Clause 19.1 must be completed without any alterations to their format, and no substitute form shall be accepted. All blank spaces shall be filled in with the information requested.
- 19.3 The Bidder shall prepare and submit an original of the first and second envelopes as described in **ITB** Clauses 12 and 13. In addition, the Bidder shall submit copies of the first and second envelopes. In the event of any discrepancy between the original and the copies, the original shall prevail.
- 19.4 Each and every page of the Bid Form, including the Bill of Quantities, under Section IX hereof, shall be signed by the duly authorized representative/s of the Bidder. Failure to do so shall be a ground for the rejection of the bid.
- 19.5 Any interlineations, erasures, or overwriting shall be valid only if they are signed or initialed by the duly authorized representative/s of the Bidder.

20. Sealing and Marking of Bids

- 20.1. Bidders shall enclose their original eligibility and technical documents described in **ITB** Clause 12, in one sealed envelope marked “ORIGINAL - TECHNICAL COMPONENT,” and the original of their financial component in another sealed envelope marked “ORIGINAL - FINANCIAL COMPONENT,” sealing them all in an outer envelope marked “ORIGINAL BID.”
- 20.2. Each copy of the first and second envelopes shall be similarly sealed duly marking the inner envelopes as “COPY NO. ___ - TECHNICAL COMPONENT” and “COPY NO. ___ – FINANCIAL COMPONENT” and the outer envelope as “COPY NO. ___,” respectively. These envelopes containing the original and the copies shall then be enclosed in one single envelope.
- 20.3. The original and the number of copies of the bid as indicated in the **BDS** shall be typed or written in ink and shall be signed by the Bidder or its duly authorized representative/s.

- 20.4. All envelopes shall:
- (a) contain the name of the contract to be bid in capital letters;
 - (b) bear the name and address of the Bidder in capital letters;
 - (c) be addressed to the Procuring Entity's BAC in accordance with **ITB** Clause 20.1;
 - (d) bear the specific identification of this bidding process indicated in the **ITB** Clause 1.2; and
 - (e) bear a warning "DO NOT OPEN BEFORE..." the date and time for the opening of bids, in accordance with **ITB** Clause 21.
- 20.5. Bid envelopes that are not properly sealed and marked, as required in the bidding documents, shall not be rejected, but the Bidder or its duly authorized representative shall acknowledge such condition of the bid as submitted. The BAC or the Procuring Entity shall assume no responsibility for the misplacement of the contents of the improperly sealed or marked bid, or for its premature opening.

D. Submission and Opening of Bids

21. Deadline for Submission of Bids

Bids must be received by the Procuring Entity's BAC at the address and on or before the date and time indicated in the **BDS**.

22. Late Bids

Any bid submitted after the deadline for submission and receipt of bids prescribed by the Procuring Entity, pursuant to **ITB** Clause 21, shall be declared "Late" and shall not be accepted by the Procuring Entity. The BAC shall record in the minutes of Bid Submission and Opening, the Bidder's name, its representative and the time the late bid was submitted.

23. Modification and Withdrawal of Bids

23.1. The Bidder may modify its bid after it has been submitted; provided that the modification is received by the Procuring Entity prior to the deadline prescribed for submission and receipt of bids. The Bidder shall not be allowed to retrieve its original bid, but shall be allowed to submit another bid equally sealed and properly identified in accordance with Clause 20, linked to its original bid marked as "TECHNICAL MODIFICATION" or "FINANCIAL MODIFICATION" and stamped "received" by the BAC. Bid modifications received after the applicable deadline shall not be considered and shall be returned to the Bidder unopened.

23.2. A Bidder may, through a Letter of Withdrawal, withdraw its bid after it has been submitted, for valid and justifiable reason; provided that the Letter of

Withdrawal is received by the Procuring Entity prior to the deadline prescribed for submission and receipt of bids. The Letter of Withdrawal must be executed by the authorized representative of the Bidder identified in the Omnibus Sworn Statement, a copy of which should be attached to the letter.

- 23.3. Bids requested to be withdrawn in accordance with **ITB** Clause 23.1 shall be returned unopened to the Bidders. A Bidder, who has acquired the bidding documents may also express its intention not to participate in the bidding through a letter which should reach and be stamped by the BAC before the deadline for submission and receipt of bids. A Bidder that withdraws its bid shall not be permitted to submit another bid, directly or indirectly, for the same contract.
- 23.4. No bid may be modified after the deadline for submission of bids. No bid may be withdrawn in the interval between the deadline for submission of bids and the expiration of the period of bid validity specified by the Bidder on the Financial Bid Form. Withdrawal of a bid during this interval shall result in the forfeiture of the Bidder's bid security, pursuant to **ITB** Clause 18.5, and the imposition of administrative, civil, and criminal sanctions as prescribed by RA 9184 and its IRR.

24. Opening and Preliminary Examination of Bids

- 24.1. The BAC shall open the Bids in public, immediately after the deadline for the submission and receipt of bids in public, as specified in the **BDS**. In case the Bids cannot be opened as scheduled due to justifiable reasons, the BAC shall take custody of the Bids submitted and reschedule the opening of Bids on the next working day or at the soonest possible time through the issuance of a Notice of Postponement to be posted in the PhilGEPS website and the website of the Procuring Entity concerned.
- 24.2. Unless otherwise specified in the BDS, the BAC shall open the first bid envelopes and determine each Bidder's compliance with the documents prescribed in ITB Clause 12, using a non-discretionary "pass/fail" criterion. If a Bidder submits the required document, it shall be rated "passed" for that particular requirement. In this regard, bids that fail to include any requirement or are incomplete or patently insufficient shall be considered as "failed". Otherwise, the BAC shall rate the said first bid envelope as "passed".
- 24.3. Unless otherwise specified in the **BDS**, immediately after determining compliance with the requirements in the first envelope, the BAC shall forthwith open the second bid envelope of each remaining eligible Bidder whose first bid envelope was rated "passed." The second envelope of each complying Bidder shall be opened within the same day. In case one or more of the requirements in the second envelope of a particular bid is missing, incomplete or patently insufficient, and/or if the submitted total bid price exceeds the ABC unless otherwise provided in **ITB** Clause 13.2, the BAC shall rate the bid concerned as "failed." Only bids that are determined to contain all the bid requirements for both components shall be rated "passed" and shall immediately be considered for evaluation and comparison.

- 24.4. Letters of Withdrawal shall be read out and recorded during bid opening, and the envelope containing the corresponding withdrawn bid shall be returned to the Bidder unopened.
- 24.5. All members of the BAC who are present during bid opening shall initial every page of the original copies of all bids received and opened.
- 24.6. In the case of an eligible foreign bidder as described in **ITB** Clause 5, the following Class “A” Documents may be substituted with the appropriate equivalent documents, if any, issued by the country of the foreign bidder concerned, which shall likewise be uploaded and maintained in the PhilGEPS in accordance with Section 8.5.2 of the IRR.:
- a) Registration certificate from the Securities and Exchange Commission (SEC), Department of Trade and Industry (DTI) for sole proprietorship, or CDA for cooperatives;
 - b) Mayor’s/Business permit issued by the local government where the principal place of business of the Bidder is located; and
 - c) Audited Financial Statements showing, among others, the prospective Bidder’s total and current assets and liabilities stamped “received” by the Bureau of Internal Revenue or its duly accredited and authorized institutions, for the preceding calendar year which should not be earlier than two years from the date of bid submission.
- 24.7. Each partner of a joint venture agreement shall likewise submit the document required in **ITB** Clause 12.1(a)(i). Submission of documents required under **ITB** Clauses 12.1(a)(ii) to 12.1(a)(iv) by any of the joint venture partners constitutes compliance.
- 24.8. The Procuring Entity shall prepare the minutes of the proceedings of the bid opening that shall include, as a minimum: (a) names of Bidders, their bid price (per lot, if applicable, and/or including discount, if any), bid security, findings of preliminary examination, and whether there is a withdrawal or modification; and (b) attendance sheet. The BAC members shall sign the abstract of bids as read.
- 24.8. The Bidders or their duly authorized representatives may attend the opening of bids. The BAC shall ensure the integrity, security, and confidentiality of all submitted bids. The Abstract of Bids as read and the minutes of the Bid Opening shall be made available to the public upon written request and payment of a specified fee to recover cost of materials.
- 24.9 To ensure transparency and accurate representation of the bid submission, the BAC Secretariat shall notify in writing all Bidders whose bids it has received through its PhilGEPS-registered physical address or official e-mail address. The notice shall be issued within seven (7) calendar days from the date of the bid opening.

E. Evaluation and Comparison of Bids

25. Process to be Confidential

- 25.1. Members of the BAC, including its staff and personnel, as well as its Secretariat and TWG, are prohibited from making or accepting any kind of communication with any Bidder regarding the evaluation of their bids until the issuance of the Notice of Award, unless otherwise allowed in the case of **ITB** Clause 26.
- 25.2. Any effort by a Bidder to influence the Procuring Entity in the Procuring Entity's decision in respect of bid evaluation, bid comparison or contract award will result in the rejection of the Bidder's bid.

26. Clarification of Bids

To assist in the evaluation, comparison and post-qualification of the bids, the Procuring Entity may ask in writing any Bidder for a clarification of its bid. All responses to requests for clarification shall be in writing. Any clarification submitted by a Bidder in respect to its bid and that is not in response to a request by the Procuring Entity shall not be considered

27. Detailed Evaluation and Comparison of Bids

- 27.1. The Procuring Entity will undertake the detailed evaluation and comparison of Bids which have passed the opening and preliminary examination of Bids, pursuant to **ITB** Clause 24, in order to determine the Lowest Calculated Bid.
- 27.2. The Lowest Calculated Bid shall be determined in two steps:
 - (a) The detailed evaluation of the financial component of the bids, to establish the correct calculated prices of the bids; and
 - (b) The ranking of the total bid prices as so calculated from the lowest to highest. The bid with the lowest price shall be identified as the Lowest Calculated Bid.
- 27.3. The Procuring Entity's BAC shall immediately conduct a detailed evaluation of all bids rated "passed," using non-discretionary "pass/fail" criterion. The BAC shall consider the following in the evaluation of bids:
 - (a) Completeness of the bid. Unless the **BDS** allows partial bids, bids not addressing or providing all of the required items in the Schedule of Requirements including, where applicable, bill of quantities, shall be considered non-responsive and, thus, automatically disqualified. In this regard, where a required item is provided, but no price is indicated, the same shall be considered as non-responsive, but specifying a zero (0) or a dash (-) for the said item would mean that it is being offered for free to the Procuring Entity, except those required by law or regulations to be provided for; and

- (b) Arithmetical corrections. Consider computational errors and omissions to enable proper comparison of all eligible bids. It may also consider bid modifications. Any adjustment shall be calculated in monetary terms to determine the calculated prices.
- 27.4. Based on the detailed evaluation of bids, those that comply with the above-mentioned requirements shall be ranked in the ascending order of their total calculated bid prices, as evaluated and corrected for computational errors, discounts and other modifications, to identify the Lowest Calculated Bid. Total calculated bid prices, as evaluated and corrected for computational errors, discounts and other modifications, which exceed the ABC shall not be considered, unless otherwise indicated in the **BDS**.
- 27.5. The Procuring Entity's evaluation of bids shall be based on the bid price quoted in the Bid Form, which includes the Bill of Quantities.
- 27.6. Bids shall be evaluated on an equal footing to ensure fair competition. For this purpose, all Bidders shall be required to include in their bids the cost of all taxes, such as, but not limited to, value added tax (VAT), income tax, local taxes, and other fiscal levies and duties which shall be itemized in the bid form and reflected in the detailed estimates. Such bids, including said taxes, shall be the basis for bid evaluation and comparison.
- 27.7. If so indicated pursuant to **ITB** Clause 1.2. Bids are being invited for individual lots or for any combination thereof, provided that all Bids and combinations of Bids shall be received by the same deadline and opened and evaluated simultaneously so as to determine the bid or combination of bids offering the lowest calculated cost to the Procuring Entity. Bid prices quoted shall correspond to all of the requirements specified for each lot. Bid Security as required by **ITB** Clause 18 shall be submitted for each contract (lot) separately. The basis for evaluation of lots is specified in **BDS** Clause 27.3.

28. Post Qualification

- 28.1. The BAC shall determine to its satisfaction whether the Bidder that is evaluated as having submitted the Lowest Calculated Bid complies with and is responsive to all the requirements and conditions specified in **ITB** Clauses 5, 12, and 13.
- 28.2. Within a non-extendible period of five (5) calendar days from receipt by the Bidder of the notice from the BAC that it submitted the Lowest Calculated Bid, the Bidder shall submit its latest income and business tax returns filed and paid through the BIR Electronic Filing and Payment System (eFPS) and other appropriate licenses and permits required by law and stated in the **BDS**.

Failure to submit any of the post-qualification requirements on time, or a finding against the veracity thereof, shall disqualify the Bidder for award. Provided in the event that a finding against the veracity of any of the documents submitted is made, it shall cause the forfeiture of the bid security in accordance with Section 69 of the IRR of RA 9184.

- 28.3. The determination shall be based upon an examination of the documentary evidence of the Bidder's qualifications submitted pursuant to **ITB** Clauses 12 and 13, as well as other information as the Procuring Entity deems necessary and appropriate, using a non-discretionary "pass/fail" criterion, which shall be completed within a period of twelve (12) calendar days.
- 28.4. If the BAC determines that the Bidder with the Lowest Calculated Bid passes all the criteria for post-qualification, it shall declare the said bid as the LCRB, and recommend to the HoPE the award of contract to the said Bidder at its submitted price or its calculated bid price, whichever is lower, subject to **ITB** Clause 30.3.
- 28.5. A negative determination shall result in rejection of the Bidder's bid, in which event the Procuring Entity shall proceed to the next Lowest Calculated Bid, with a fresh period to make a similar determination of that Bidder's capabilities to perform satisfactorily. If the second Bidder, however, fails the post qualification, the procedure for post qualification shall be repeated for the Bidder with the next Lowest Calculated Bid, and so on until the LCRB is determined for recommendation of contract award.
- 28.6. Within a period not exceeding fifteen (15) calendar days from the determination by the BAC of the LCRB and the recommendation to award the contract, the HoPE or his duly authorized representative shall approve or disapprove the said recommendation.
- 28.7. In the event of disapproval, which shall be based on valid, reasonable, and justifiable grounds as provided for under Section 41 of the IRR of RA 9184, the HoPE shall notify the BAC and the Bidder in writing of such decision and the grounds for it. When applicable, the BAC shall conduct a post-qualification of the Bidder with the next Lowest Calculated Bid. A request for reconsideration may be filed by the Bidder with the HoPE in accordance with Section 37.1.3 of the IRR of RA 9184.

29. Reservation Clause

- 29.1. Notwithstanding the eligibility or post-qualification of a Bidder, the Procuring Entity concerned reserves the right to review its qualifications at any stage of the procurement process if it has reasonable grounds to believe that a misrepresentation has been made by the said Bidder, or that there has been a change in the Bidder's capability to undertake the project from the time it submitted its eligibility requirements. Should such review uncover any misrepresentation made in the eligibility and bidding requirements, statements or documents, or any changes in the situation of the Bidder which will affect its capability to undertake the project so that it fails the preset eligibility or bid evaluation criteria, the Procuring Entity shall consider the said Bidder as ineligible and shall disqualify it from submitting a bid or from obtaining an award or contract.
- 29.2. Based on the following grounds, the Procuring Entity reserves the right to reject any and all Bids, declare a Failure of Bidding at any time prior to the contract award, or not to award the contract, without thereby incurring any

liability, and make no assurance that a contract shall be entered into as a result of the bidding:

- (a) If there is *prima facie* evidence of collusion between appropriate public officers or employees of the Procuring Entity, or between the BAC and any of the Bidders, or if the collusion is between or among the Bidders themselves, or between a Bidder and a third party, including any act which restricts, suppresses or nullifies or tends to restrict, suppress or nullify competition;
- (b) If the Procuring Entity's BAC is found to have failed in following the prescribed bidding procedures; or
- (c) For any justifiable and reasonable ground where the award of the contract will not redound to the benefit of the GOP as follows:
 - (i) If the physical and economic conditions have significantly changed so as to render the project no longer economically, financially or technically feasible as determined by the HoPE;
 - (ii) If the project is no longer necessary as determined by the HoPE; and
 - (iii) If the source of funds for the project has been withheld or reduced through no fault of the Procuring Entity.

29.3. In addition, the Procuring Entity may likewise declare a failure of bidding when:

- (a) No bids are received;
- (b) All prospective Bidders are declared ineligible;
- (c) All bids fail to comply with all the bid requirements, fail post-qualification; or
- (d) The Bidder with the LCRB refuses, without justifiable cause, to accept the award of contract, and no award is made in accordance with Section 40 of the IRR of RA 9184.

F. Award of Contract

30. Contract Award

- 30.1. Subject to **ITB** Clause 28, the HoPE or its duly authorized representative shall award the contract to the Bidder whose bid has been determined to be the LCRB.
- 30.2. Prior to the expiration of the period of bid validity, the Procuring Entity shall notify the successful Bidder in writing that its bid has been accepted, through a Notice of Award duly received by the Bidder or its representative personally or by registered mail or electronically, receipt of which must be confirmed in

writing within two (2) days by the Bidder with the LCRB and submitted personally or sent by registered mail or electronically to the Procuring Entity.

- 30.3. Notwithstanding the issuance of the Notice of Award, award of contract shall be subject to the following conditions:
- (a) Submission of the following documents within ten (10) calendar days from receipt of the Notice of Award:
 - (i) In the case of procurement by a Philippine Foreign Service Office or Post, the PhilGEPS Registration Number of the winning foreign Bidder; or
 - (ii) Valid PCAB license and registration for the type and cost of the contract to be bid for foreign bidders when the Treaty or International or Executive Agreement expressly allows submission of the PCAB license and registration for the type and cost of the contract to be bid as a pre-condition to the Award;
 - (b) Posting of the performance security in accordance with **ITB** Clause 32;
 - (c) Signing of the contract as provided in **ITB** Clause 31; and
 - (d) Approval by higher authority, if required, as provided in Section 37.3 of the IRR of RA 9184.

31. Signing of the Contract

- 31.1. At the same time as the Procuring Entity notifies the successful Bidder that its bid has been accepted, the Procuring Entity shall send the Contract Form to the Bidder, which Contract has been provided in the Bidding Documents, incorporating therein all agreements between the parties.
- 31.2. Within ten (10) calendar days from receipt of the Notice of Award, the successful Bidder shall post the required performance security, sign and date the contract and return it to the Procuring Entity.
- 31.3. The Procuring Entity shall enter into contract with the successful Bidder within the same ten (10) calendar day period provided that all the documentary requirements are complied with.
- 31.4. The following documents shall form part of the contract:
- (a) Contract Agreement;
 - (b) Bidding Documents;
 - (c) Winning Bidder's bid, including the Technical and Financial Proposals, and all other documents/statements submitted (*e.g.*, Bidder's response to request for clarifications on the bid), including

corrections to the bid, if any, resulting from the Procuring Entity’s bid evaluation;

- (d) Performance Security;
- (e) Notice of Award of Contract; and
- (f) Other contract documents that may be required by existing laws and/or specified in the **BDS**.

32. Performance Security

- 32.1. To guarantee the faithful performance by the winning Bidder of its obligations under the contract, it shall post a performance security within a maximum period of ten (10) calendar days from the receipt of the Notice of Award from the Procuring Entity and in no case later than the signing of the contract.
- 32.2. The Performance Security shall be denominated in Philippine Pesos and posted in favor of the Procuring Entity in an amount not less than the percentage of the total contract price in accordance with the following schedule:

Form of Performance Security	Amount of Performance Security (Not less than the Percentage of the Total Contract Price)
<p>(a) Cash or cashier’s/manager’s check issued by a Universal or Commercial Bank.</p> <p><i>For biddings conducted by the LGUs, the Cashier’s/Manager’s Check may be issued by other banks certified by the BSP as authorized to issue such financial instrument.</i></p>	<p>Ten percent (10%)</p>
<p>(b) Bank draft/guarantee or irrevocable letter of credit issued by a Universal or Commercial Bank: Provided, however, that it shall be confirmed or authenticated by a Universal or Commercial Bank, if issued by a foreign bank.</p> <p><i>For biddings conducted by the LGUs, Bank Draft/Guarantee, or Irrevocable Letter of Credit may be issued by other banks certified by the BSP as authorized to issue such</i></p>	

<i>financial instrument.</i>	
(c) Surety bond callable upon demand issued by a surety or insurance company duly certified by the Insurance Commission as authorized to issue such security.	Thirty percent (30%)

32.3. Failure of the successful Bidder to comply with the above-mentioned requirement shall constitute sufficient ground for the annulment of the award and forfeiture of the bid security, in which event the Procuring Entity shall have a fresh period to initiate and complete the post qualification of the second Lowest Calculated Bid. The procedure shall be repeated until LCRB is identified and selected for recommendation of contract award. However if no Bidder passed post-qualification, the BAC shall declare the bidding a failure and conduct a re-bidding with re-advertisement, if necessary.

33. Notice to Proceed

Within seven (7) calendar days from the date of approval of the Contract by the appropriate government approving authority, the Procuring Entity shall issue the Notice to Proceed (NTP) together with a copy or copies of the approved contract to the successful Bidder. All notices called for by the terms of the contract shall be effective only at the time of receipt thereof by the successful Bidder.

34. Protest Mechanism

Decision of the procuring entity at any stage of the procurement process may be questioned in accordance with Sections 55 of the IRR of RA 9184.

Section III. Bid Data Sheet

Notes on the Bid Data Sheet

This Section is intended to assist the Procuring Entity in providing the specific information in relation to corresponding clauses in the ITB included in Section II, and has to be prepared for each specific procurement.

The Procuring Entity should specify in the BDS information and requirements specific to the circumstances of the Procuring Entity, the processing of the procurement, the applicable rules regarding bid price and currency, and the bid evaluation criteria that will apply to the Bids. In preparing this Section, the following aspects should be checked:

- (a) Information that specifies and complements provisions of Section II. Instructions to Bidders must be incorporated.
- (b) Amendments and/or supplements, if any, to provisions of Section II. Instructions to Bidders as necessitated by the circumstances of the specific procurement, must also be incorporated.

For foreign-assisted projects, the Bid Data Sheet to be used is provided in Section X- Foreign-Assisted Projects.

Bid Data Sheet

ITB Clause	
1.1	<p>The Procuring Entity is Quezon City Government</p> <p>The name of the Contract is PROPOSED REHABILITATION OF ROAD AND DRAINAGE AT DON PEPE STREET, BARANGAY STA. MONICA</p> <p>The identification number of the Contract is Invitation to Bid No. 20-00092</p>
2	<p>The Funding Source is:</p> <p>The Government of the Philippines (GOP) through Engineering-Continuing in the amount of Four Million Five Hundred Ninety Eight Thousand Eight Hundred Eighty Pesos & 56/100 Cts. (₱ 4,598,880.56).</p> <p><i>NOTE: In the case of National Government Agencies, the General Appropriations Act and/or continuing appropriations; in the case of Government-Owned and/or –Controlled Corporations, Government Financial Institutions, and State Universities and Colleges, the Corporate Budget for the contract approved by the governing Boards; in the case of Local Government Units, the Budget for the contract approved by the respective Sanggunian.</i></p> <p>The name of the Project is Proposed Rehabilitation of Road and Drainage at Don Pepe Street</p>
5.1	<p>In addition, eligible bidders shall qualify or comply with the following:</p> <ol style="list-style-type: none"> 1. Bidders with valid Philippine Contractors Accreditation Board (PCAB) Type <ul style="list-style-type: none"> ● Roads - Small B 2. Completed construction project(s) which is similar to the Project and which cost at least fifty percent (50%) of the ABC.
5.2	Bidding is restricted to eligible bidders as defined in ITB Clause 5.1.
5.4(a)	No further instructions.
5.4(b)	For this purpose, similar contracts shall refer to contracts which have the same major categories of work.
6.1	The Bidder or its duly authorized representative shall submit a validly executed sworn statement and other validly executed bidding forms prescribed in Section IX. Bidding Forms (Omnibus Sworn Statement, Affidavit of Undertaking, Bid Securing Declaration & Affidavit of Site Inspection)

6.3	The Bidder, by the act of submitting its bid, shall be deemed to have inspected the site and shall submit site inspection report/certification.
8.1	Subcontracting is not allowed
8.2	Not applicable
9.1	The QC-BAC- Infrastructure and Consultancy will hold a pre-bid conference for this Project on December 02, 2020 – 10:00 A.M. at 2 nd Floor, Procurement Department-Bidding Room, Finance Building, Quezon City Hall Compound or we encourage the prospective bidders to join through our Virtual Conference (ZOOM APP) Meeting ID: 89111859539 Password : 598996
10.1	The Procuring Entity's address is: QUEZON CITY GOVERNMENT Quezon City Hall Compound Barangay Central, Quezon City ATTY. DOMINIC B. GARCIA <i>Procurement Department</i> <i>2nd Floor, Finance Building,</i> <i>Quezon City Hall Compound,</i> <i>Barangay Central, Quezon City</i> <i>8988-4242 loc. 8709/8710</i> <i>Email Add: procurement@quezoncity.gov.ph</i> <i>Website: www.quezoncity.gov.ph</i>
12.1	Additional Contract Documents relevant to the Project as required: 1. Construction Schedule and S-curve, 2. Manpower Schedule, 3. Construction Methods, 4. Equipment Utilization Schedule, 5. PERT/CPM or other acceptable tools of project scheduling, shall be included in the submission of Technical Proposal.
12.1(a) (ii)	Statement of all its ongoing government and private contracts, including contracts awarded but not yet started, if any, whether similar or not similar in nature and complexity to the contract to be bid within the last three (3) years prior to the deadline for the submission and receipt of bids substantially in a form prescribed by the QC-BAC Infrastructure and Consultancy; and Statement of the Bidder's Single Largest Completed Contract (SLCC) similar to the contract to be bid, in accordance with ITB Clause 5.4, within the last three (3) years prior to the deadline for the submission and receipt of bids substantially in a form prescribed by the QC-BAC Infrastructure and Consultancy, must be accompanied by a copy of Certificate of Acceptance by the end-user or Official Receipt (O.R.) or Sales Invoice (S.I.) issued for the contract.
12.1 (a) (iii)	Computation of Net Financial Contracting Capacity (NFCC) should be in a form prescribed by the QC-BAC Infrastructure and Consultancy and in

	accordance with ITB Clause 5.5 or a committed Line of Credit from a Universal or Commercial bank.																																																
12.1(b)(ii.2)	<p>The minimum work experience requirements for key personnel are the following:</p> <table border="1" data-bbox="389 413 1453 1059"> <thead> <tr> <th data-bbox="389 468 483 525">Qty.</th> <th data-bbox="483 468 971 525"><u>Key Personnel</u></th> <th data-bbox="971 468 1198 525"><u>General Experience</u></th> <th data-bbox="1198 468 1455 525"><u>Relevant Experience</u></th> </tr> </thead> <tbody> <tr> <td data-bbox="389 525 483 583">1</td> <td data-bbox="483 525 971 583"><i>Project Manager</i></td> <td data-bbox="971 525 1198 583">3 years</td> <td data-bbox="1198 525 1455 583">3 years</td> </tr> <tr> <td data-bbox="389 583 483 640">1</td> <td data-bbox="483 583 971 640"><i>Project Engineer</i></td> <td data-bbox="971 583 1198 640">3 years</td> <td data-bbox="1198 583 1455 640">3 years</td> </tr> <tr> <td data-bbox="389 640 483 697">1</td> <td data-bbox="483 640 971 697"><i>Material Engineer</i></td> <td data-bbox="971 640 1198 697">3 years</td> <td data-bbox="1198 640 1455 697">3 years</td> </tr> <tr> <td data-bbox="389 697 483 755">1</td> <td data-bbox="483 697 971 755"><i>Safety Officer</i></td> <td data-bbox="971 697 1198 755">3 years</td> <td data-bbox="1198 697 1455 755">3 years</td> </tr> <tr> <td data-bbox="389 755 483 812">1</td> <td data-bbox="483 755 971 812"><i>Surveyor</i></td> <td data-bbox="971 755 1198 812">3 years</td> <td data-bbox="1198 755 1455 812">3 years</td> </tr> <tr> <td data-bbox="389 812 483 869">1</td> <td data-bbox="483 812 971 869"><i>Surveyor Assistant</i></td> <td data-bbox="971 812 1198 869">3 years</td> <td data-bbox="1198 812 1455 869">3 years</td> </tr> <tr> <td data-bbox="389 869 483 927">1</td> <td data-bbox="483 869 971 927"><i>Procurement Officer</i></td> <td data-bbox="971 869 1198 927">3 years</td> <td data-bbox="1198 869 1455 927">3 years</td> </tr> <tr> <td data-bbox="389 927 483 984">12</td> <td data-bbox="483 927 971 984"><i>Equipment Operator</i></td> <td data-bbox="971 927 1198 984">3 years</td> <td data-bbox="1198 927 1455 984">3 years</td> </tr> <tr> <td data-bbox="389 984 483 1041">8</td> <td data-bbox="483 984 971 1041"><i>Equipment Assistant</i></td> <td data-bbox="971 984 1198 1041">3 years</td> <td data-bbox="1198 984 1455 1041">3 years</td> </tr> <tr> <td data-bbox="389 1041 483 1098">1</td> <td data-bbox="483 1041 971 1098"><i>General Foreman</i></td> <td data-bbox="971 1041 1198 1098">3 years</td> <td data-bbox="1198 1041 1455 1098">3 years</td> </tr> <tr> <td data-bbox="389 1098 483 1156">5</td> <td data-bbox="483 1098 971 1156"><i>Laborer</i></td> <td data-bbox="971 1098 1198 1156">3 years</td> <td data-bbox="1198 1098 1455 1156">3 years</td> </tr> </tbody> </table> <p data-bbox="389 1066 1455 1173"><i>In addition, the bidder must execute an affidavit of undertaking duly notarized stating that the foregoing personnel shall perform work exclusively for the project until its completion. Please see attached Affidavit of Undertaking.</i></p>	Qty.	<u>Key Personnel</u>	<u>General Experience</u>	<u>Relevant Experience</u>	1	<i>Project Manager</i>	3 years	3 years	1	<i>Project Engineer</i>	3 years	3 years	1	<i>Material Engineer</i>	3 years	3 years	1	<i>Safety Officer</i>	3 years	3 years	1	<i>Surveyor</i>	3 years	3 years	1	<i>Surveyor Assistant</i>	3 years	3 years	1	<i>Procurement Officer</i>	3 years	3 years	12	<i>Equipment Operator</i>	3 years	3 years	8	<i>Equipment Assistant</i>	3 years	3 years	1	<i>General Foreman</i>	3 years	3 years	5	<i>Laborer</i>	3 years	3 years
Qty.	<u>Key Personnel</u>	<u>General Experience</u>	<u>Relevant Experience</u>																																														
1	<i>Project Manager</i>	3 years	3 years																																														
1	<i>Project Engineer</i>	3 years	3 years																																														
1	<i>Material Engineer</i>	3 years	3 years																																														
1	<i>Safety Officer</i>	3 years	3 years																																														
1	<i>Surveyor</i>	3 years	3 years																																														
1	<i>Surveyor Assistant</i>	3 years	3 years																																														
1	<i>Procurement Officer</i>	3 years	3 years																																														
12	<i>Equipment Operator</i>	3 years	3 years																																														
8	<i>Equipment Assistant</i>	3 years	3 years																																														
1	<i>General Foreman</i>	3 years	3 years																																														
5	<i>Laborer</i>	3 years	3 years																																														
12.1(b)(ii.3)	<p>The minimum major equipment requirements are the following:</p> <table border="1" data-bbox="389 1280 1453 1789"> <thead> <tr> <th data-bbox="389 1280 971 1348"><u>Equipment</u></th> <th data-bbox="971 1280 1198 1348"><u>Capacity</u></th> <th data-bbox="1198 1280 1455 1348"><u>Number of Units</u></th> </tr> </thead> <tbody> <tr> <td data-bbox="389 1348 971 1405"><i>Backhoe w/ Concrete Breaker</i></td> <td data-bbox="971 1348 1198 1405"></td> <td data-bbox="1198 1348 1455 1405">1</td> </tr> <tr> <td data-bbox="389 1405 971 1462"><i>Jackhammer</i></td> <td data-bbox="971 1405 1198 1462"></td> <td data-bbox="1198 1405 1455 1462">1</td> </tr> <tr> <td data-bbox="389 1462 971 1520"><i>Dump Truck</i></td> <td data-bbox="971 1462 1198 1520"></td> <td data-bbox="1198 1462 1455 1520">1</td> </tr> <tr> <td data-bbox="389 1520 971 1577"><i>Payloader</i></td> <td data-bbox="971 1520 1198 1577"></td> <td data-bbox="1198 1520 1455 1577">1</td> </tr> <tr> <td data-bbox="389 1577 971 1634"><i>Motorized Road Grader</i></td> <td data-bbox="971 1577 1198 1634"></td> <td data-bbox="1198 1577 1455 1634">1</td> </tr> <tr> <td data-bbox="389 1634 971 1692"><i>Vibratory Roller</i></td> <td data-bbox="971 1634 1198 1692"></td> <td data-bbox="1198 1634 1455 1692">1</td> </tr> <tr> <td data-bbox="389 1692 971 1749"><i>Water Truck</i></td> <td data-bbox="971 1692 1198 1749"></td> <td data-bbox="1198 1692 1455 1749">1</td> </tr> <tr> <td data-bbox="389 1749 971 1806"><i>Concrete Vibrator</i></td> <td data-bbox="971 1749 1198 1806"></td> <td data-bbox="1198 1749 1455 1806">1</td> </tr> <tr> <td data-bbox="389 1806 971 1864"><i>Plate Compactor</i></td> <td data-bbox="971 1806 1198 1864"></td> <td data-bbox="1198 1806 1455 1864">1</td> </tr> <tr> <td data-bbox="389 1864 971 1921"><i>Concrete Mixer (2-Bagger)</i></td> <td data-bbox="971 1864 1198 1921"></td> <td data-bbox="1198 1864 1455 1921">1</td> </tr> <tr> <td data-bbox="389 1921 971 1978"><i>Elf Truck</i></td> <td data-bbox="971 1921 1198 1978"></td> <td data-bbox="1198 1921 1455 1978">1</td> </tr> </tbody> </table> <p data-bbox="389 1814 1455 1921"><i>In addition, the bidder must execute an affidavit of undertaking duly notarized stating that the foregoing equipment shall be used exclusively for the project until its completion. Please see attached Affidavit of Undertaking.</i></p>	<u>Equipment</u>	<u>Capacity</u>	<u>Number of Units</u>	<i>Backhoe w/ Concrete Breaker</i>		1	<i>Jackhammer</i>		1	<i>Dump Truck</i>		1	<i>Payloader</i>		1	<i>Motorized Road Grader</i>		1	<i>Vibratory Roller</i>		1	<i>Water Truck</i>		1	<i>Concrete Vibrator</i>		1	<i>Plate Compactor</i>		1	<i>Concrete Mixer (2-Bagger)</i>		1	<i>Elf Truck</i>		1												
<u>Equipment</u>	<u>Capacity</u>	<u>Number of Units</u>																																															
<i>Backhoe w/ Concrete Breaker</i>		1																																															
<i>Jackhammer</i>		1																																															
<i>Dump Truck</i>		1																																															
<i>Payloader</i>		1																																															
<i>Motorized Road Grader</i>		1																																															
<i>Vibratory Roller</i>		1																																															
<i>Water Truck</i>		1																																															
<i>Concrete Vibrator</i>		1																																															
<i>Plate Compactor</i>		1																																															
<i>Concrete Mixer (2-Bagger)</i>		1																																															
<i>Elf Truck</i>		1																																															
12.1.(b).(iii)	<p>The bidder's authorized signatory is the one who executes the Omnibus Sworn Statement, otherwise, a separate Special Power of Attorney (SPA), Board Resolution and or Secretary's Certificate shall be attached in support of the Omnibus Sworn Statement.</p> <p>An Affidavit of Site Inspection shall also be submitted or as part of the Omnibus Sworn Statement.</p>																																																

13.1	"No additional Requirements.
13.1(b)	This shall include all of the following documents: <ul style="list-style-type: none"> • Bid prices in the Bill of Quantities; • Detailed estimates, including a summary sheet indicating the unit prices of construction materials, labor rates, and equipment rentals used in coming up with the Bid; and • Cash flow by quarter or payment schedule.
13.2	The ABC is Four Million Five Hundred Ninety Eight Thousand Eight Hundred Eighty Pesos & 56/100 Cts. (₱ 4,598,880.56) . Any bid with a financial component exceeding this amount shall not be accepted.
14.2	No further instructions
15.4	No further instruction
16.1	The bid prices shall be quoted in Philippine Pesos.
16.3	No further instructions.
17.1	Bids will be valid until 120 calendar days from opening of bids Surety Bond issued by the private insurance company shall be callable on demand, valid up to 120cd, affixed with documentary stamps, with original Official Receipt of premium payment, and accompanied by a Certificate of Authority to issue such security by the Insurance Commission. For bonds issued by the GSIS certification by the Insurance Commission and documentary stamps are not required.
18.1	The bid security shall be in the form of a Bid Securing Declaration or any of the following forms and amounts: <ul style="list-style-type: none"> • The amount of not less than Ninety One Thousand Nine Hundred Seventy Seven Pesos & 61/100 cts. ₱ 91,977.61 [2% of ABC], if bid security is in cash, cashier's/manager's check, bank draft/guarantee or irrevocable letter of credit; • The amount of not less than Two Hundred Twenty Nine Thousand Nine Hundred Forty Four Pesos & 03/100 cts. ₱ 229,944.03 [5% of ABC] if bid security is in Surety Bond.
18.2	The bid security shall be valid until 120 calendar days from opening of bids.
19.3	The Bidder shall prepare and submit an original of the first and second envelopes as described in ITB Clauses 12 and 13.
21	The address for submission of bids is Bids and Awards Committee (BAC) <i>Bidding Room, Procurement Department, 2nd Floor, Civic Center Building F, Quezon City Hall Compound, Barangay Central, Quezon City</i> The deadline for submission of bids is 9:00 AM, December 14, 2020
22	Any bid submitted after the deadline for submission and receipt of bids prescribed by the Procuring Entity, pursuant to ITB Clause 21, shall be declared "Late" and shall not be accepted by the Procuring Entity.

24.1	<p>The place of bid opening is at Bids and Awards Committee (BAC) <i>Bidding Room, Procurement Department, 2nd Floor, Civic Center Building F, Quezon City Hall Compound, Barangay Central, Quezon City</i></p> <p>The date and time of bid opening is 10:00 AM, December 14, 2020</p>
24.2	No further instructions.
24.3	No further instructions.
27.3	No further instructions.
27.4	No further instructions.
28.2	No further instructions.

Section IV. General Conditions of Contract

Notes on the General Conditions of Contract

The GCC in Section IV, read in conjunction with the SCC in Section V and other documents listed therein, should be a complete document expressing all the rights and obligations of the parties.

The GCC herein shall not be altered. Any changes and complementary information, which may be needed, shall be introduced only through the SCC in Section V.

TABLE OF CONTENTS

1. DEFINITIONS.....	40
2. INTERPRETATION	42
3. GOVERNING LANGUAGE AND LAW.....	43
4. COMMUNICATIONS	43
5. POSSESSION OF SITE	43
6. THE CONTRACTOR’S OBLIGATIONS	44
7. PERFORMANCE SECURITY	45
8. SUBCONTRACTING	46
9. LIQUIDATED DAMAGES	46
10. SITE INVESTIGATION REPORTS	46
11. THE PROCURING ENTITY, LICENSES AND PERMITS	46
12. CONTRACTOR’S RISK AND WARRANTY SECURITY.....	47
13. LIABILITY OF THE CONTRACTOR	49
14. PROCURING ENTITY’S RISK	49
15. INSURANCE.....	49
16. TERMINATION FOR DEFAULT OF CONTRACTOR.....	51
17. TERMINATION FOR DEFAULT OF PROCURING ENTITY	51
18. TERMINATION FOR OTHER CAUSES	52
19. PROCEDURES FOR TERMINATION OF CONTRACTS	53
20. FORCE MAJEURE, RELEASE FROM PERFORMANCE	56
21. RESOLUTION OF DISPUTES	56
22. SUSPENSION OF LOAN, CREDIT, GRANT, OR APPROPRIATION.....	57
23. PROCURING ENTITY’S REPRESENTATIVE’S DECISIONS.....	57
24. APPROVAL OF DRAWINGS AND TEMPORARY WORKS BY THE PROCURING ENTITY’S REPRESENTATIVE.....	57
25. ACCELERATION AND DELAYS ORDERED BY THE PROCURING ENTITY’S REPRESENTATIVE.....	58
26. EXTENSION OF THE INTENDED COMPLETION DATE	58
27. RIGHT TO VARY	58
28. CONTRACTORS RIGHT TO CLAIM.....	59

29. DAYWORKS.....	59
30. EARLY WARNING	59
31. PROGRAM OF WORK	59
32. MANAGEMENT CONFERENCES	60
33. BILL OF QUANTITIES	60
34. INSTRUCTIONS, INSPECTIONS AND AUDITS	61
35. IDENTIFYING DEFECTS	61
36. COST OF REPAIRS.....	61
37. CORRECTION OF DEFECTS	61
38. UNCORRECTED DEFECTS.....	62
39. ADVANCE PAYMENT	62
40. PROGRESS PAYMENTS	62
41. PAYMENT CERTIFICATES	63
42. RETENTION.....	64
43. VARIATION ORDERS	64
44. CONTRACT COMPLETION.....	66
45. SUSPENSION OF WORK	66
46. PAYMENT ON TERMINATION	67
47. EXTENSION OF CONTRACT TIME.....	67
48. PRICE ADJUSTMENT	69
49. COMPLETION.....	69
50. TAKING OVER	69
51. OPERATING AND MAINTENANCE MANUALS	69

1. Definitions

For purposes of this Clause, boldface type is used to identify defined terms.

- 1.1. The **Arbiter** is the person appointed jointly by the Procuring Entity and the Contractor to resolve disputes in the first instance, as provided for in **GCC Clause 21**.
- 1.2. **Bill of Quantities** refers to a list of the specific items of the Work and their corresponding unit prices, lump sums, and/or provisional sums.
- 1.3. The **Completion Date** is the date of completion of the Works as certified by the Procuring Entity's Representative, in accordance with **GCC Clause 49**.
- 1.4. The **Contract** is the contract between the Procuring Entity and the Contractor to execute, complete, and maintain the Works.
- 1.5. The **Contract Effectivity Date** is the date of signing of the Contract. However, the contractor shall commence execution of the Works on the Start Date as defined in **GCC Clause 1.28**.
- 1.6. The **Contract Price** is the price stated in the Notice of Award and thereafter to be paid by the Procuring Entity to the Contractor for the execution of the Works in accordance with this Contract
- 1.7. **Contract Time Extension** is the allowable period for the Contractor to complete the Works in addition to the original Completion Date stated in this Contract.
- 1.8. The **Contractor** is the juridical entity whose proposal has been accepted by the Procuring Entity and to whom the Contract to execute the Work was awarded.
- 1.9. The **Contractor's Bid** is the signed offer or proposal submitted by the Contractor to the Procuring Entity in response to the Bidding Documents.
- 1.10. **Days** are calendar days; months are calendar months.
- 1.11. **Dayworks** are varied work inputs subject to payment on a time basis for the Contractor's employees and Equipment, in addition to payments for associated Materials and Plant.
- 1.12. A **Defect** is any part of the Works not completed in accordance with the Contract.
- 1.13. The **Defects Liability Certificate** is the certificate issued by Procuring Entity's Representative upon correction of defects by the Contractor.
- 1.14. The **Defects Liability Period** is the one year period between contract completion and final acceptance within which the Contractor assumes the responsibility to undertake the repair of any damage to the Works at his own expense.

- 1.15 **Drawings** are graphical presentations of the Works. They include all supplementary details, shop drawings, calculations, and other information provided or approved for the execution of this Contract.
- 1.16 **Equipment** refers to all facilities, supplies, appliances, materials or things required for the execution and completion of the Work provided by the Contractor and which shall not form or are not intended to form part of the Permanent Works.
- 1.17 The **Intended Completion Date** refers to the date specified in the **SCC** when the Contractor is expected to have completed the Works. The Intended Completion Date may be revised only by the Procuring Entity's Representative by issuing an extension of time or an acceleration order.
- 1.18 **Materials** are all supplies, including consumables, used by the Contractor for incorporation in the Works.
- 1.19 The **Notice to Proceed** is a written notice issued by the Procuring Entity or the Procuring Entity's Representative to the Contractor requiring the latter to begin the commencement of the work not later than a specified or determinable date.
- 1.20 **Permanent Works** are all permanent structures and all other project features and facilities required to be constructed and completed in accordance with this Contract which shall be delivered to the Procuring Entity and which shall remain at the Site after the removal of all Temporary Works.
- 1.21 **Plant** refers to the machinery, apparatus, and the like intended to form an integral part of the Permanent Works.
- 1.22 The **Procuring Entity** is the party who employs the Contractor to carry out the Works stated in the **SCC**.
- 1.23 The **Procuring Entity's Representative** refers to the Head of the Procuring Entity or his duly authorized representative, identified in the **SCC**, who shall be responsible for supervising the execution of the Works and administering this Contract.
- 1.24 The **Site** is the place provided by the Procuring Entity where the Works shall be executed and any other place or places which may be designated in the **SCC**, or notified to the Contractor by the Procuring Entity's Representative as forming part of the Site.
- 1.25 **Site Investigation Reports** are those that were included in the Bidding Documents and are factual and interpretative reports about the surface and subsurface conditions at the Site.
- 1.26 **Slippage** is a delay in work execution occurring when actual accomplishment falls below the target as measured by the difference between the scheduled and actual accomplishment of the Work by the Contractor as established from the work schedule. This is actually described as a percentage of the whole Works.

- 1.27 **Specifications** means the description of Works to be done and the qualities of materials to be used, the equipment to be installed and the mode of construction.
- 1.28 The **Start Date**, as specified in the **SCC**, is the date when the Contractor is obliged to commence execution of the Works. It does not necessarily coincide with any of the Site Possession Dates.
- 1.29 A **Subcontractor** is any person or organization to whom a part of the Works has been subcontracted by the Contractor, as allowed by the Procuring Entity, but not any assignee of such person.
- 1.30 **Temporary Works** are works designed, constructed, installed, and removed by the Contractor that are needed for construction or installation of the Permanent Works.
- 1.31 **Work(s)** refer to the Permanent Works and Temporary Works to be executed by the Contractor in accordance with this Contract, including (i) the furnishing of all labor, materials, equipment and others incidental, necessary or convenient to the complete execution of the Works; (ii) the passing of any tests before acceptance by the Procuring Entity's Representative; (iii) and the carrying out of all duties and obligations of the Contractor imposed by this Contract as described in the **SCC**.

2. Interpretation

- 2.1. In interpreting the Conditions of Contract, singular also means plural, male also means female or neuter, and the other way around. Headings have no significance. Words have their normal meaning under the language of this Contract unless specifically defined. The Procuring Entity's Representative will provide instructions clarifying queries about the Conditions of Contract.
- 2.2. If sectional completion is specified in the **SCC**, references in the Conditions of Contract to the Works, the Completion Date, and the Intended Completion Date apply to any Section of the Works (other than references to the Completion Date and Intended Completion Date for the whole of the Works).
- 2.3. The documents forming this Contract shall be interpreted in the following order of priority:
- a) Contract Agreement;
 - b) Bid Data Sheet;
 - c) Instructions to Bidders;
 - d) Addenda to the Bidding Documents;
 - e) Special Conditions of Contract;
 - f) General Conditions of Contract;

- g) Specifications;
- h) Bill of Quantities; and
- i) Drawings.

3. Governing Language and Law

- 3.1. This Contract has been executed in the English language, which shall be the binding and controlling language for all matters relating to the meaning or interpretation of this Contract. All correspondence and other documents pertaining to this Contract which are exchanged by the parties shall be written in English.
- 3.2. This Contract shall be interpreted in accordance with the laws of the Republic of the Philippines.

4. Communications

Communications between parties that are referred to in the Conditions shall be effective only when in writing. A notice shall be effective only when it is received by the concerned party.

5. Possession of Site

- 5.1. On the date specified in the SCC, the Procuring Entity shall grant the Contractor possession of so much of the Site as may be required to enable it to proceed with the execution of the Works. If the Contractor suffers delay or incurs cost from failure on the part of the Procuring Entity to give possession in accordance with the terms of this clause, the Procuring Entity's Representative shall give the Contractor a Contract Time Extension and certify such sum as fair to cover the cost incurred, which sum shall be paid by Procuring Entity.
- 5.2. If possession of a portion is not given by the date stated in the SCC Clause 5.1, the Procuring Entity will be deemed to have delayed the start of the relevant activities. The resulting adjustments in contract time to address such delay shall be in accordance with **GCC** Clause 47.
- 5.3. The Contractor shall bear all costs and charges for special or temporary right-of-way required by it in connection with access to the Site. The Contractor shall also provide at his own cost any additional facilities outside the Site required by it for purposes of the Works.
- 5.4. The Contractor shall allow the Procuring Entity's Representative and any person authorized by the Procuring Entity's Representative access to the Site and to any place where work in connection with this Contract is being carried out or is intended to be carried out.

6. The Contractor's Obligations

- 6.1. The Contractor shall carry out the Works properly and in accordance with this Contract. The Contractor shall provide all supervision, labor, Materials, Plant and Contractor's Equipment, which may be required. All Materials and Plant on Site shall be deemed to be the property of the Procuring Entity.
- 6.2. The Contractor shall commence execution of the Works on the Start Date and shall carry out the Works in accordance with the Program of Work submitted by the Contractor, as updated with the approval of the Procuring Entity's Representative, and complete them by the Intended Completion Date.
- 6.3. The Contractor shall be responsible for the safety of all activities on the Site.
- 6.4. The Contractor shall carry out all instructions of the Procuring Entity's Representative that comply with the applicable laws where the Site is located.
- 6.5. The Contractor shall employ the key personnel named in the Schedule of Key Personnel, as referred to in the SCC, to carry out the supervision of the Works. The Procuring Entity will approve any proposed replacement of key personnel only if their relevant qualifications and abilities are equal to or better than those of the personnel listed in the Schedule.
- 6.6. If the Procuring Entity's Representative asks the Contractor to remove a member of the Contractor's staff or work force, for justifiable cause, the Contractor shall ensure that the person leaves the Site within seven (7) days and has no further connection with the Work in this Contract.
- 6.7. During Contract implementation, the Contractor and his subcontractors shall abide at all times by all labor laws, including child labor related enactments, and other relevant rules.
- 6.8. The Contractor shall submit to the Procuring Entity for consent the name and particulars of the person authorized to receive instructions on behalf of the Contractor.
- 6.9. The Contractor shall cooperate and share the Site with other contractors, public authorities, utilities, and the Procuring Entity between the dates given in the schedule of other contractors particularly when they shall require access to the Site. The Contractor shall also provide facilities and services for them during this period. The Procuring Entity may modify the schedule of other contractors, and shall notify the Contractor of any such modification thereto.
- 6.10. Should anything of historical or other interest or of significant value be unexpectedly discovered on the Site, it shall be the property of the Procuring Entity. The Contractor shall notify the Procuring Entity's Representative of such discoveries and carry out the Procuring Entity's Representative's instructions in dealing with them.

7. Performance Security

- 7.1. Within ten (10) calendar days from receipt of the Notice of Award from the Procuring Entity but in no case later than the signing of the contract by both parties, the Contractor shall furnish the performance security in any of the forms prescribed in **ITB** Clause 32.2.
- 7.2. The performance security posted in favor of the Procuring Entity shall be forfeited in the event it is established that the Contractor is in default in any of its obligations under the Contract.
- 7.3. The performance security shall remain valid until issuance by the Procuring Entity of the Certificate of Final Acceptance.
- 7.4. The performance security may be released by the Procuring Entity and returned to the Contractor after the issuance of the Certificate of Final Acceptance subject to the following conditions:
 - (a) There are no pending claims against the Contractor or the surety company filed by the Procuring Entity;
 - (b) The Contractor has no pending claims for labor and materials filed against it; and
 - (c) Other terms specified in the **SCC**.
- 7.5. The Contractor shall post an additional performance security following the amount and form specified in **ITB** Clause 32.2 to cover any cumulative increase of more than ten percent (10%) over the original value of the contract as a result of amendments to order or change orders, extra work orders and supplemental agreements, as the case may be. The Contractor shall cause the extension of the validity of the performance security to cover approved contract time extensions.
- 7.6. In case of a reduction in the contract value or for partially completed Works under the contract which are usable and accepted by the Procuring Entity the use of which, in the judgment of the implementing agency or the Procuring Entity, will not affect the structural integrity of the entire project, the Procuring Entity shall allow a proportional reduction in the original performance security, provided that any such reduction is more than ten percent (10%) and that the aggregate of such reductions is not more than fifty percent (50%) of the original performance security.
- 7.7. Unless otherwise indicated in the **SCC**, the Contractor, by entering into the Contract with the Procuring Entity, acknowledges the right of the Procuring Entity to institute action pursuant to Act 3688 against any subcontractor be they an individual, firm, partnership, corporation, or association supplying the Contractor with labor, materials and/or equipment for the performance of this Contract.

8. Subcontracting

- 8.1. Unless otherwise indicated in the **SCC**, the Contractor cannot subcontract Works more than the percentage specified in **BDS** Clause 8.1.
- 8.2. Subcontracting of any portion of the Works does not relieve the Contractor of any liability or obligation under this Contract. The Contractor will be responsible for the acts, defaults, and negligence of any subcontractor, its agents, servants or workmen as fully as if these were the Contractor's own acts, defaults, or negligence, or those of its agents, servants or workmen.
- 8.3. If subcontracting is allowed. The contractor may identify its subcontractor during contract implementation stage. Subcontractors disclosed and identified during the bidding may be changed during the implementation of this Contract. In either case, subcontractors must submit the documentary requirements under ITB Clause 12 and comply with the eligibility criteria specified in the **BDS**. In the event that any subcontractor is found by any Procuring Entity to be eligible, the subcontracting of such portion of the Works shall be disallowed.

9. Liquidated Damages

- 9.1. The Contractor shall pay liquidated damages to the Procuring Entity for each day that the Completion Date is later than the Intended Completion Date. The applicable liquidated damages is at least one-tenth (1/10) of a percent of the cost of the unperformed portion for every day of delay. The total amount of liquidated damages shall not exceed ten percent (10%) of the amount of the contract. The Procuring Entity may deduct liquidated damages from payments due to the Contractor. Payment of liquidated damages shall not affect the Contractor's liabilities. Once the cumulative amount of liquidated damages reaches ten percent (10%) of the amount of this Contract, the Procuring Entity may rescind or terminate this Contract, without prejudice to other courses of action and remedies available under the circumstances.
- 9.2. If the Intended Completion Date is extended after liquidated damages have been paid, the Engineer of the Procuring Entity shall correct any overpayment of liquidated damages by the Contractor by adjusting the next payment certificate.

10. Site Investigation Reports

The Contractor, in preparing the Bid, shall rely on any Site Investigation Reports referred to in the **SCC** supplemented by any information obtained by the Contractor.

11. The Procuring Entity, Licenses and Permits

The Procuring Entity shall, if requested by the Contractor, assist him in applying for permits, licenses or approvals, which are required for the Works.

12. Contractor's Risk and Warranty Security

- 12.1. The Contractor shall assume full responsibility for the Works from the time project construction commenced up to final acceptance by the Procuring Entity and shall be held responsible for any damage or destruction of the Works except those occasioned by *force majeure*. The Contractor shall be fully responsible for the safety, protection, security, and convenience of his personnel, third parties, and the public at large, as well as the Works, Equipment, installation, and the like to be affected by his construction work.
- 12.2. The defects liability period for infrastructure projects shall be one year from contract completion up to final acceptance by the Procuring Entity. During this period, the Contractor shall undertake the repair works, at his own expense, of any damage to the Works on account of the use of materials of inferior quality within ninety (90) days from the time the HoPE has issued an order to undertake repair. In case of failure or refusal to comply with this mandate, the Procuring Entity shall undertake such repair works and shall be entitled to full reimbursement of expenses incurred therein upon demand.
- 12.3. Unless otherwise indicated in the **SCC**, in case the Contractor fails to comply with the preceding paragraph, the Procuring Entity shall forfeit its performance security, subject its property(ies) to attachment or garnishment proceedings, and perpetually disqualify it from participating in any public bidding. All payables of the GoP in his favor shall be offset to recover the costs.
- 12.4. After final acceptance of the Works by the Procuring Entity, the Contractor shall be held responsible for "Structural Defects," *i.e.*, major faults/flaws/deficiencies in one or more key structural elements of the project which may lead to structural failure of the completed elements or structure, or "Structural Failures," *i.e.*, where one or more key structural elements in an infrastructure facility fails or collapses, thereby rendering the facility or part thereof incapable of withstanding the design loads, and/or endangering the safety of the users or the general public:
 - (a) Contractor – Where Structural Defects/Failures arise due to faults attributable to improper construction, use of inferior quality/substandard materials, and any violation of the contract plans and specifications, the contractor shall be held liable;
 - (b) Consultants – Where Structural Defects/Failures arise due to faulty and/or inadequate design and specifications as well as construction supervision, then the consultant who prepared the design or undertook construction supervision for the project shall be held liable;
 - (c) Procuring Entity's Representatives/Project Manager/Construction Managers and Supervisors – The project owner's representative(s), project manager, construction manager, and supervisor(s) shall be held liable in cases where the Structural Defects/Failures are due to his/their willful intervention in altering the designs and other specifications; negligence or omission in not approving or acting on proposed changes

to noted defects or deficiencies in the design and/or specifications; and the use of substandard construction materials in the project;

- (d) Third Parties - Third Parties shall be held liable in cases where Structural Defects/Failures are caused by work undertaken by them such as leaking pipes, diggings or excavations, underground cables and electrical wires, underground tunnel, mining shaft and the like, in which case the applicable warranty to such structure should be levied to third parties for their construction or restoration works.
- (e) Users - In cases where Structural Defects/Failures are due to abuse/misuse by the end user of the constructed facility and/or non-compliance by a user with the technical design limits and/or intended purpose of the same, then the user concerned shall be held liable.

12.5. The warranty against Structural Defects/Failures, except those occasioned on force majeure, shall cover the period specified in the **SCC** reckoned from the date of issuance of the Certificate of Final Acceptance by the Procuring Entity.

12.6. The Contractor shall be required to put up a warranty security in the form of cash, bank guarantee, letter of credit, GSIS or surety bond callable on demand, in accordance with the following schedule:

Form of Warranty	Amount of Warranty Security Not less than the Percentage (%) of Total Contract Price
(a) Cash or letter of credit issued by Universal or Commercial bank: provided, however, that the letter of credit shall be confirmed or authenticated by a Universal or Commercial bank, if issued by a foreign bank	Five Percent (5%)
(b) Bank guarantee confirmed by Universal or Commercial bank: provided, however, that the letter of credit shall be confirmed or authenticated by a Universal or Commercial bank, if issued by a foreign bank	Ten Percent (10%)
(c) Surety bond callable upon demand issued by GSIS or any surety or insurance company duly certified by the Insurance Commission	Thirty Percent (30%)

12.7. The warranty security shall be stated in Philippine Pesos and shall remain effective for one year from the date of issuance of the Certificate of Final Acceptance by the Procuring Entity, and returned only after the lapse of said one year period.

- 12.8. In case of structural defects/failure occurring during the applicable warranty period provided in **GCC** Clause 12.5, the Procuring Entity shall undertake the necessary restoration or reconstruction works and shall be entitled to full reimbursement by the parties found to be liable for expenses incurred therein upon demand, without prejudice to the filing of appropriate administrative, civil, and/or criminal charges against the responsible persons as well as the forfeiture of the warranty security posted in favor of the Procuring Entity.

13. Liability of the Contractor

Subject to additional provisions, if any, set forth in the **SCC**, the Contractor's liability under this Contract shall be as provided by the laws of the Republic of the Philippines.

14. Procuring Entity's Risk

- 14.1. From the Start Date until the Certificate of Final Acceptance has been issued, the following are risks of the Procuring Entity:
- (a) The risk of personal injury, death, or loss of or damage to property (excluding the Works, Plant, Materials, and Equipment), which are due to:
 - (i) any type of use or occupation of the Site authorized by the Procuring Entity after the official acceptance of the works; or
 - (ii) negligence, breach of statutory duty, or interference with any legal right by the Procuring Entity or by any person employed by or contracted to him except the Contractor.
 - (b) The risk of damage to the Works, Plant, Materials, and Equipment to the extent that it is due to a fault of the Procuring Entity or in the Procuring Entity's design, or due to war or radioactive contamination directly affecting the country where the Works are to be executed.

15. Insurance

- 15.1. The Contractor shall, under his name and at his own expense, obtain and maintain, for the duration of this Contract, the following insurance coverage:
- (a) Contractor's All Risk Insurance;
 - (b) Transportation to the project Site of Equipment, Machinery, and Supplies owned by the Contractor;
 - (c) Personal injury or death of Contractor's employees; and
 - (d) Comprehensive insurance for third party liability to Contractor's direct or indirect act or omission causing damage to third persons.
- 15.2. The Contractor shall provide evidence to the Procuring Entity's Representative that the insurances required under this Contract have been

effected and shall, within a reasonable time, provide copies of the insurance policies to the Procuring Entity's Representative. Such evidence and such policies shall be provided to the Procuring Entity's through the Procuring Entity's Representative.

- 15.3. The Contractor shall notify the insurers of changes in the nature, extent, or program for the execution of the Works and ensure the adequacy of the insurances at all times in accordance with the terms of this Contract and shall produce to the Procuring Entity's Representative the insurance policies in force including the receipts for payment of the current premiums.

The above insurance policies shall be obtained from any reputable insurance company approved by the Procuring Entity's Representative.

- 15.4. If the Contractor fails to obtain and keep in force the insurances referred to herein or any other insurance which he may be required to obtain under the terms of this Contract, the Procuring Entity may obtain and keep in force any such insurances and pay such premiums as may be necessary for the purpose. From time to time, the Procuring Entity may deduct the amount it shall pay for said premiums including twenty five percent (25%) therein from any monies due, or which may become due, to the Contractor, without prejudice to the Procuring Entity exercising its right to impose other sanctions against the Contractor pursuant to the provisions of this Contract.

- 15.5. In the event the Contractor fails to observe the above safeguards, the Procuring Entity may, at the Contractor's expense, take whatever measure is deemed necessary for its protection and that of the Contractor's personnel and third parties, and/or order the interruption of dangerous Works. In addition, the Procuring Entity may refuse to make the payments under GCC Clause 40 until the Contractor complies with this Clause.

- 15.6. The Contractor shall immediately replace the insurance policy obtained as required in this Contract, without need of the Procuring Entity's demand, with a new policy issued by a new insurance company acceptable to the Procuring Entity for any of the following grounds:

- (a) The issuer of the insurance policy to be replaced has:
 - (i) become bankrupt;
 - (ii) been placed under receivership or under a management committee;
 - (iii) been sued for suspension of payment; or
 - (iv) been suspended by the Insurance Commission and its license to engage in business or its authority to issue insurance policies cancelled; or

- (v) Where reasonable grounds exist that the insurer may not be able, fully and promptly, to fulfill its obligation under the insurance policy.

16. Termination for Default of Contractor

16.1. The Procuring Entity shall terminate this Contract for default when any of the following conditions attend its implementation:

- (i) Due to the Contractor's fault and while the project is on-going, it has incurred negative slippage of fifteen percent (15%) or more in accordance with Presidential Decree 1870, regardless of whether or not previous warnings and notices have been issued for the Contractor to improve his performance;
- (ii) Due to its own fault and after this Contract time has expired, the Contractor incurs delay in the completion of the Work after this Contract has expired; or
- (iii) The Contractor:
 - (i) abandons the contract Works, refuses or fails to comply with a valid instruction of the Procuring Entity or fails to proceed expeditiously and without delay despite a written notice by the Procuring Entity;
 - (ii) does not actually have on the project Site the minimum essential equipment listed on the bid necessary to prosecute the Works in accordance with the approved Program of Work and equipment deployment schedule as required for the project;
 - (iii) does not execute the Works in accordance with this Contract or persistently or flagrantly neglects to carry out its obligations under this Contract;
 - (iv) neglects or refuses to remove materials or to perform a new Work that has been rejected as defective or unsuitable; or
 - (v) sub-lets any part of this Contract without approval by the Procuring Entity.

16.2. All materials on the Site, Plant, Works, including Equipment purchased and funded under the Contract shall be deemed to be the property of the Procuring Entity if this Contract is rescinded because of the Contractor's default.

17. Termination for Default of Procuring Entity

The Contractor may terminate this Contract with the Procuring Entity if the works are completely stopped for a continuous period of at least sixty (60) calendar days through no fault of its own, due to any of the following reasons:

- (a) Failure of the Procuring Entity to deliver, within a reasonable time, supplies, materials, right-of-way, or other items it is obligated to furnish under the terms of this Contract; or
- (b) The prosecution of the Work is disrupted by the adverse peace and order situation, as certified by the Armed Forces of the Philippines Provincial Commander and approved by the Secretary of National Defense.

18. Termination for Other Causes

- 18.1. The Procuring Entity may terminate this Contract, in whole or in part, at any time for its convenience. The HoPE may terminate this Contract for the convenience of the Procuring Entity if he has determined the existence of conditions that make Project Implementation economically, financially or technically impractical and/or unnecessary, such as, but not limited to, fortuitous event(s) or changes in law and National Government policies.
- 18.2. The Procuring Entity or the Contractor may terminate this Contract if the other party causes a fundamental breach of this Contract.
- 18.3. Fundamental breaches of Contract shall include, but shall not be limited to, the following:
 - (a) The Contractor stops work for twenty eight (28) days when no stoppage of work is shown on the current Program of Work and the stoppage has not been authorized by the Procuring Entity's Representative;
 - (b) The Procuring Entity's Representative instructs the Contractor to delay the progress of the Works, and the instruction is not withdrawn within twenty eight (28) days;
 - (c) The Procuring Entity shall terminate this Contract if the Contractor is declared bankrupt or insolvent as determined with finality by a court of competent jurisdiction. In this event, termination will be without compensation to the Contractor, provided that such termination will not prejudice or affect any right of action or remedy which has accrued or will accrue thereafter to the Procuring Entity and/or the Contractor. In the case of the Contractor's insolvency, any Contractor's Equipment which the Procuring Entity instructs in the notice is to be used until the completion of the Works;
 - (d) A payment certified by the Procuring Entity's Representative is not paid by the Procuring Entity to the Contractor within eighty four (84) days from the date of the Procuring Entity's Representative's certificate;
 - (e) The Procuring Entity's Representative gives Notice that failure to correct a particular Defect is a fundamental breach of Contract and the Contractor fails to correct it within a reasonable period of time determined by the Procuring Entity's Representative;

- (f) The Contractor does not maintain a Security, which is required;
 - (g) The Contractor has delayed the completion of the Works by the number of days for which the maximum amount of liquidated damages can be paid, as defined in the **GCC** Clause 9; and
 - (h) In case it is determined prima facie by the Procuring Entity that the Contractor has engaged, before or during the implementation of the contract, in unlawful deeds and behaviors relative to contract acquisition and implementation, such as, but not limited to, the following:
 - (i) corrupt, fraudulent, collusive, coercive, and obstructive practices as defined in **ITB** Clause 3.1(a), unless otherwise specified in the SCC;
 - (ii) drawing up or using forged documents;
 - (iii) using adulterated materials, means or methods, or engaging in production contrary to rules of science or the trade; and
 - (iv) any other act analogous to the foregoing.
- 18.4. The Funding Source or the Procuring Entity, as appropriate, will seek to impose the maximum civil, administrative and/or criminal penalties available under the applicable law on individuals and organizations deemed to be involved with corrupt, fraudulent, or coercive practices.
- 18.5. When persons from either party to this Contract gives notice of a fundamental breach to the Procuring Entity's Representative in order to terminate the existing contract for a cause other than those listed under **GCC** Clause 18.3, the Procuring Entity's Representative shall decide whether the breach is fundamental or not.
- 18.6. If this Contract is terminated, the Contractor shall stop work immediately, make the Site safe and secure, and leave the Site as soon as reasonably possible.

19. Procedures for Termination of Contracts

- 19.1. The following provisions shall govern the procedures for the termination of this Contract:
- (a) Upon receipt of a written report of acts or causes which may constitute ground(s) for termination as aforementioned, or upon its own initiative, the Procuring Entity shall, within a period of seven (7) calendar days, verify the existence of such ground(s) and cause the execution of a Verified Report, with all relevant evidence attached;
 - (b) Upon recommendation by the Procuring Entity, the HoPE shall terminate this Contract only by a written notice to the Contractor conveying the termination of this Contract. The notice shall state:

- (i) that this Contract is being terminated for any of the ground(s) afore-mentioned, and a statement of the acts that constitute the ground(s) constituting the same;
- (ii) the extent of termination, whether in whole or in part;
- (iii) an instruction to the Contractor to show cause as to why this Contract should not be terminated; and
- (iv) special instructions of the Procuring Entity, if any.

The Notice to Terminate shall be accompanied by a copy of the Verified Report;

- (c) Within a period of seven (7) calendar days from receipt of the Notice of Termination, the Contractor shall submit to the HoPE a verified position paper stating why the contract should not be terminated. If the Contractor fails to show cause after the lapse of the seven (7) day period, either by inaction or by default, the HoPE shall issue an order terminating the contract;
- (d) The Procuring Entity may, at anytime before receipt of the Contractor's verified position paper described in item (c) above withdraw the Notice to Terminate if it is determined that certain items or works subject of the notice had been completed, delivered, or performed before the Contractor's receipt of the notice;
- (e) Within a non-extendible period of ten (10) calendar days from receipt of the verified position paper, the HoPE shall decide whether or not to terminate this Contract. It shall serve a written notice to the Contractor of its decision and, unless otherwise provided in the said notice, this Contract is deemed terminated from receipt of the Contractor of the notice of decision. The termination shall only be based on the ground(s) stated in the Notice to Terminate; and
- (f) The HoPE may create a Contract Termination Review Committee (CTRC) to assist him in the discharge of this function. All decisions recommended by the CTRC shall be subject to the approval of the HoPE.

19.2. Pursuant to Section 69(f) of RA 9184 and without prejudice to the imposition of additional administrative sanctions as the internal rules of the agency may provide and/or further criminal prosecution as provided by applicable laws, the procuring entity shall impose on contractors after the termination of the contract the penalty of suspension for one (1) year for the first offense, suspension for two (2) years for the second offense from participating in the public bidding process, for violations committed during the contract implementation stage, which include but not limited to the following:

- (a) Failure of the contractor, due solely to his fault or negligence, to mobilize and start work or performance within the specified period in the Notice to Proceed (“NTP”);
- (b) Failure by the contractor to fully and faithfully comply with its contractual obligations without valid cause, or failure by the contractor to comply with any written lawful instruction of the procuring entity or its representative(s) pursuant to the implementation of the contract. For the procurement of infrastructure projects or consultancy contracts, lawful instructions include but are not limited *to* the following:
 - (i) Employment of competent technical personnel, competent engineers and/or work supervisors;
 - (ii) Provision of warning signs and barricades in accordance with approved plans and specifications and contract provisions;
 - (iii) Stockpiling in proper places of all materials and removal from the project site of waste and excess materials, including broken pavement and excavated debris in accordance with approved plans and specifications and contract provisions;
 - (iv) Deployment of committed equipment, facilities, support staff and manpower; and
 - (v) Renewal of the effectivity dates of the performance security after its expiration during the course of contract implementation.
- (c) Assignment and subcontracting of the contract or any part thereof or substitution of key personnel named in the proposal without prior written approval by the procuring entity.
- (d) Poor performance by the contractor or unsatisfactory quality and/or progress of work arising from his fault or negligence as reflected in the Constructor's Performance Evaluation System (“CPES”) rating sheet. In the absence of the CPES rating sheet, the existing performance monitoring system of the procuring entity shall be applied. Any of the following acts by the Contractor shall be construed as poor performance:
 - (i) Negative slippage of 15% and above within the critical path of the project due entirely to the fault or negligence of the contractor; and
 - (ii) Quality of materials and workmanship not complying with the approved specifications arising from the contractor's fault or negligence.

- (e) Willful or deliberate abandonment or non-performance of the project or contract by the contractor resulting to substantial breach thereof without lawful and/or just cause.

In addition to the penalty of suspension, the performance security posted by the contractor shall also be forfeited.

20. Force Majeure, Release From Performance

- 20.1. For purposes of this Contract the terms “*force majeure*” and “fortuitous event” may be used interchangeably. In this regard, a fortuitous event or *force majeure* shall be interpreted to mean an event which the Contractor could not have foreseen, or which though foreseen, was inevitable. It shall not include ordinary unfavorable weather conditions; and any other cause the effects of which could have been avoided with the exercise of reasonable diligence by the Contractor.
- 20.2. If this Contract is discontinued by an outbreak of war or by any other event entirely outside the control of either the Procuring Entity or the Contractor, the Procuring Entity’s Representative shall certify that this Contract has been discontinued. The Contractor shall make the Site safe and stop work as quickly as possible after receiving this certificate and shall be paid for all works carried out before receiving it and for any Work carried out afterwards to which a commitment was made.
- 20.3. If the event continues for a period of eighty four (84) days, either party may then give notice of termination, which shall take effect twenty eight (28) days after the giving of the notice.
- 20.4. After termination, the Contractor shall be entitled to payment of the unpaid balance of the value of the Works executed and of the materials and Plant reasonably delivered to the Site, adjusted by the following:
 - (a) any sum to which the Contractor is entitled under GCC Clause 28;
 - (b) the cost of his suspension and demobilization;
 - (c) any sum to which the Procuring Entity is entitled.
- 20.5. The net balance due shall be paid or repaid within a reasonable time period from the time of the notice of termination.

21. Resolution of Disputes

- 21.1. If any dispute or difference of any kind whatsoever shall arise between the parties in connection with the implementation of the contract covered by the Act and this IRR, the parties shall make every effort to resolve amicably such dispute or difference by mutual consultation.
- 21.2. If the Contractor believes that a decision taken by the Procuring Entity’s Representative was either outside the authority given to the Procuring Entity’s

Representative by this Contract or that the decision was wrongly taken, the decision shall be referred to the Arbiter indicated in the **SCC** within fourteen (14) days of the notification of the Procuring Entity's Representative's decision.

- 21.3. Any and all disputes arising from the implementation of this Contract covered by the R.A. 9184 and its IRR shall be submitted to arbitration in the Philippines according to the provisions of Republic Act No. 876, otherwise known as the "Arbitration Law" and Republic Act 9285, otherwise known as the "Alternative Dispute Resolution Act of 2004": *Provided, however*, That, disputes that are within the competence of the Construction Industry Arbitration Commission to resolve shall be referred thereto. The process of arbitration shall be incorporated as a provision in this Contract that will be executed pursuant to the provisions of the Act and its IRR: *Provided, further*, That, by mutual agreement, the parties may agree in writing to resort to other alternative modes of dispute resolution.

22. Suspension of Loan, Credit, Grant, or Appropriation

In the event that the Funding Source suspends the Loan, Credit, Grant, or Appropriation to the Procuring Entity, from which part of the payments to the Contractor are being made:

- (a) The Procuring Entity is obligated to notify the Contractor of such suspension within seven (7) days of having received the suspension notice.
- (b) If the Contractor has not received sums due it for work already done within forty five (45) days from the time the Contractor's claim for payment has been certified by the Procuring Entity's Representative, the Contractor may immediately issue a suspension of work notice in accordance with **GCC** Clause 45.2.

23. Procuring Entity's Representative's Decisions

- 23.1. Except where otherwise specifically stated, the Procuring Entity's Representative will decide contractual matters between the Procuring Entity and the Contractor in the role representing the Procuring Entity.
- 23.2. The Procuring Entity's Representative may delegate any of his duties and responsibilities to other people, except to the Arbiter, after notifying the Contractor, and may cancel any delegation after notifying the Contractor.

24. Approval of Drawings and Temporary Works by the Procuring Entity's Representative

- 24.1. All Drawings prepared by the Contractor for the execution of the Temporary Works, are subject to prior approval by the Procuring Entity's Representative before its use.
- 24.2. The Contractor shall be responsible for design of Temporary Works.

- 24.3. The Procuring Entity's Representative's approval shall not alter the Contractor's responsibility for design of the Temporary Works.
- 24.4. The Contractor shall obtain approval of third parties to the design of the Temporary Works, when required by the Procuring Entity.

25. Acceleration and Delays Ordered by the Procuring Entity's Representative

- 25.1. When the Procuring Entity wants the Contractor to finish before the Intended Completion Date, the Procuring Entity's Representative will obtain priced proposals for achieving the necessary acceleration from the Contractor. If the Procuring Entity accepts these proposals, the Intended Completion Date will be adjusted accordingly and confirmed by both the Procuring Entity and the Contractor.
- 25.2. If the Contractor's Financial Proposals for an acceleration are accepted by the Procuring Entity, they are incorporated in the Contract Price and treated as a Variation.

26. Extension of the Intended Completion Date

- 26.1. The Procuring Entity's Representative shall extend the Intended Completion Date if a Variation is issued which makes it impossible for the Intended Completion Date to be achieved by the Contractor without taking steps to accelerate the remaining work, which would cause the Contractor to incur additional costs. No payment shall be made for any event which may warrant the extension of the Intended Completion Date.
- 26.2. The Procuring Entity's Representative shall decide whether and by how much to extend the Intended Completion Date within twenty one (21) days of the Contractor asking the Procuring Entity's Representative for a decision thereto after fully submitting all supporting information. If the Contractor has failed to give early warning of a delay or has failed to cooperate in dealing with a delay, the delay by this failure shall not be considered in assessing the new Intended Completion Date.

27. Right to Vary

- 27.1. The Procuring Entity's Representative with the prior approval of the Procuring Entity may instruct Variations, up to a maximum cumulative amount of ten percent (10%) of the original contract cost.
- 27.2. Variations shall be valued as follows:
- (a) At a lump sum price agreed between the parties;
 - (b) where appropriate, at rates in this Contract;
 - (c) in the absence of appropriate rates, the rates in this Contract shall be used as the basis for valuation; or failing which

- (d) at appropriate new rates, equal to or lower than current industry rates and to be agreed upon by both parties and approved by the HoPE.

28. Contractor's Right to Claim

If the Contractor incurs cost as a result of any of the events under **GCC** Clause 13, the Contractor shall be entitled to the amount of such cost. If as a result of any of the said events, it is necessary to change the Works, this shall be dealt with as a Variation.

29. Dayworks

- 29.1. Subject to **GCC** Clause 43 on Variation Order, and if applicable as indicated in the **SCC**, the Dayworks rates in the Contractor's bid shall be used for small additional amounts of work only when the Procuring Entity's Representative has given written instructions in advance for additional work to be paid for in that way.
- 29.2. All work to be paid for as Dayworks shall be recorded by the Contractor on forms approved by the Procuring Entity's Representative. Each completed form shall be verified and signed by the Procuring Entity's Representative within two days of the work being done.
- 29.3. The Contractor shall be paid for Dayworks subject to obtaining signed Dayworks forms.

30. Early Warning

- 30.1. The Contractor shall warn the Procuring Entity's Representative at the earliest opportunity of specific likely future events or circumstances that may adversely affect the quality of the work, increase the Contract Price, or delay the execution of the Works. The Procuring Entity's Representative may require the Contractor to provide an estimate of the expected effect of the future event or circumstance on the Contract Price and Completion Date. The estimate shall be provided by the Contractor as soon as reasonably possible.
- 30.2. The Contractor shall cooperate with the Procuring Entity's Representative in making and considering proposals for how the effect of such an event or circumstance can be avoided or reduced by anyone involved in the work and in carrying out any resulting instruction of the Procuring Entity's Representative.

31. Program of Work

- 31.1. Within the time stated in the **SCC**, the Contractor shall submit to the Procuring Entity's Representative for approval a Program of Work showing the general methods, arrangements, order, and timing for all the activities in the Works.
- 31.2. An update of the Program of Work shall show the actual progress achieved on each activity and the effect of the progress achieved on the timing of the remaining work, including any changes to the sequence of the activities.

- 31.3. The Contractor shall submit to the Procuring Entity's Representative for approval an updated Program of Work at intervals no longer than the period stated in the **SCC**. If the Contractor does not submit an updated Program of Work within this period, the Procuring Entity's Representative may withhold the amount stated in the **SCC** from the next payment certificate and continue to withhold this amount until the next payment after the date on which the overdue Program of Work has been submitted.
- 31.4. The Procuring Entity's Representative's approval of the Program of Work shall not alter the Contractor's obligations. The Contractor may revise the Program of Work and submit it to the Procuring Entity's Representative again at any time. A revised Program of Work shall show the effect of any approved Variations.
- 31.5. When the Program of Work is updated, the Contractor shall provide the Procuring Entity's Representative with an updated cash flow forecast. The cash flow forecast shall include different currencies, as defined in the Contract, converted as necessary using the Contract exchange rates.
- 31.6. All Variations shall be included in updated Program of Work produced by the Contractor.

32. Management Conferences

- 32.1. Either the Procuring Entity's Representative or the Contractor may require the other to attend a Management Conference. The Management Conference shall review the plans for remaining work and deal with matters raised in accordance with the early warning procedure.
- 32.2. The Procuring Entity's Representative shall record the business of Management Conferences and provide copies of the record to those attending the Conference and to the Procuring Entity. The responsibility of the parties for actions to be taken shall be decided by the Procuring Entity's Representative either at the Management Conference or after the Management Conference and stated in writing to all who attended the Conference.

33. Bill of Quantities

- 33.1. The Bill of Quantities shall contain items of work for the construction, installation, testing, and commissioning of work to be done by the Contractor.
- 33.2. The Bill of Quantities is used to calculate the Contract Price. The Contractor is paid for the quantity of the work done at the rate in the Bill of Quantities for each item.
- 33.3. If the final quantity of any work done differs from the quantity in the Bill of Quantities for the particular item and is not more than twenty five percent (25%) of the original quantity, provided the aggregate changes for all items do not exceed ten percent (10%) of the Contract price, the Procuring Entity's Representative shall make the necessary adjustments to allow for the changes subject to applicable laws, rules, and regulations.

- 33.4. If requested by the Procuring Entity's Representative, the Contractor shall provide the Procuring Entity's Representative with a detailed cost breakdown of any rate in the Bill of Quantities.

34. Instructions, Inspections and Audits

- 34.1. The Procuring Entity's personnel shall at all reasonable times during construction of the Work be entitled to examine, inspect, measure and test the materials and workmanship, and to check the progress of the construction.
- 34.2. If the Procuring Entity's Representative instructs the Contractor to carry out a test not specified in the Specification to check whether any work has a defect and the test shows that it does, the Contractor shall pay for the test and any samples. If there is no defect, the test shall be a Compensation Event.
- 34.3. The Contractor shall permit the Funding Source named in the SCC to inspect the Contractor's accounts and records relating to the performance of the Contractor and to have them audited by auditors appointed by the Funding Source, if so required by the Funding Source.

35. Identifying Defects

The Procuring Entity's Representative shall check the Contractor's work and notify the Contractor of any defects that are found. Such checking shall not affect the Contractor's responsibilities. The Procuring Entity's Representative may instruct the Contractor to search uncover defects and test any work that the Procuring Entity's Representative considers below standards and defective.

36. Cost of Repairs

Loss or damage to the Works or Materials to be incorporated in the Works between the Start Date and the end of the Defects Liability Periods shall be remedied by the Contractor at the Contractor's cost if the loss or damage arises from the Contractor's acts or omissions.

37. Correction of Defects

- 37.1. The Procuring Entity's Representative shall give notice to the Contractor of any defects before the end of the Defects Liability Period, which is One (1) year from project completion up to final acceptance by the Procuring Entity's Representative.
- 37.2. Every time notice of a defect is given, the Contractor shall correct the notified defect within the length of time specified in the Procuring Entity's Representative's notice.
- 37.3. The Contractor shall correct the defects which he notices himself before the end of the Defects Liability Period.
- 37.4. The Procuring Entity shall certify that all defects have been corrected. If the Procuring Entity considers that correction of a defect is not essential, he can

request the Contractor to submit a quotation for the corresponding reduction in the Contract Price. If the Procuring Entity accepts the quotation, the corresponding change in the SCC is a Variation.

38. Uncorrected Defects

- 38.1. The Procuring Entity shall give the Contractor at least fourteen (14) days notice of his intention to use a third party to correct a Defect. If the Contractor does not correct the Defect himself within the period, the Procuring Entity may have the Defect corrected by the third party. The cost of the correction will be deducted from the Contract Price.
- 38.2. The use of a third party to correct defects that are uncorrected by the Contractor will in no way relieve the Contractor of its liabilities and warranties under the Contract.

39. Advance Payment

- 39.1. The Procuring Entity shall, upon a written request of the contractor which shall be submitted as a contract document, make an advance payment to the contractor in an amount not exceeding fifteen percent (15%) of the total contract price, to be made in lump sum or, at the most two, installments according to a schedule specified in the **SCC**.
- 39.2. The advance payment shall be made only upon the submission to and acceptance by the Procuring Entity of an irrevocable standby letter of credit of equivalent value from a commercial bank, a bank guarantee or a surety bond callable upon demand, issued by a surety or insurance company duly licensed by the Insurance Commission and confirmed by the Procuring Entity.
- 39.3. The advance payment shall be repaid by the Contractor by an amount equal to the percentage of the total contract price used for the advance payment.
- 39.4. The contractor may reduce his standby letter of credit or guarantee instrument by the amounts refunded by the Monthly Certificates in the advance payment.
- 39.5. The Procuring Entity will provide an Advance Payment on the Contract Price as stipulated in the Conditions of Contract, subject to the maximum amount stated in **SCC** Clause 39.1.

40. Progress Payments

- 40.1. The Contractor may submit a request for payment for Work accomplished. Such request for payment shall be verified and certified by the Procuring Entity's Representative/Project Engineer. Except as otherwise stipulated in the **SCC**, materials and equipment delivered on the site but not completely put in place shall not be included for payment.
- 40.2. The Procuring Entity shall deduct the following from the certified gross amounts to be paid to the contractor as progress payment:

- (a) Cumulative value of the work previously certified and paid for.
 - (b) Portion of the advance payment to be recouped for the month.
 - (c) Retention money in accordance with the condition of contract.
 - (d) Amount to cover third party liabilities.
 - (e) Amount to cover uncorrected discovered defects in the works.
- 40.3. Payments shall be adjusted by deducting therefrom the amounts for advance payments and retention. The Procuring Entity shall pay the Contractor the amounts certified by the Procuring Entity's Representative within twenty eight (28) days from the date each certificate was issued. No payment of interest for delayed payments and adjustments shall be made by the Procuring Entity.
- 40.4. The first progress payment may be paid by the Procuring Entity to the Contractor provided that at least twenty percent (20%) of the work has been accomplished as certified by the Procuring Entity's Representative.
- 40.5. Items of the Works for which a price of "0" (zero) has been entered will not be paid for by the Procuring Entity and shall be deemed covered by other rates and prices in the Contract.

41. Payment Certificates

- 41.1. The Contractor shall submit to the Procuring Entity's Representative monthly statements of the estimated value of the work executed less the cumulative amount certified previously.
- 41.2. The Procuring Entity's Representative shall check the Contractor's monthly statement and certify the amount to be paid to the Contractor.
- 41.3. The value of Work executed shall:
- (a) be determined by the Procuring Entity's Representative;
 - (b) comprise the value of the quantities of the items in the Bill of Quantities completed; and
 - (c) include the valuations of approved variations.
- 41.4. The Procuring Entity's Representative may exclude any item certified in a previous certificate or reduce the proportion of any item previously certified in any certificate in the light of later information.

42. Retention

- 42.1. The Procuring Entity shall retain from each payment due to the Contractor an amount equal to a percentage thereof using the rate as specified in GCC Sub-Clause 42.2.
- 42.2. Progress payments are subject to retention of ten percent (10%), referred to as the “retention money.” Such retention shall be based on the total amount due to the Contractor prior to any deduction and shall be retained from every progress payment until fifty percent (50%) of the value of Works, as determined by the Procuring Entity, are completed. If, after fifty percent (50%) completion, the Work is satisfactorily done and on schedule, no additional retention shall be made; otherwise, the ten percent (10%) retention shall again be imposed using the rate specified therefor.
- 42.3. The total “retention money” shall be due for release upon final acceptance of the Works. The Contractor may, however, request the substitution of the retention money for each progress billing with irrevocable standby letters of credit from a commercial bank, bank guarantees or surety bonds callable on demand, of amounts equivalent to the retention money substituted for and acceptable to the Procuring Entity, provided that the project is on schedule and is satisfactorily undertaken. Otherwise, the ten (10%) percent retention shall be made. Said irrevocable standby letters of credit, bank guarantees and/or surety bonds, to be posted in favor of the Government shall be valid for a duration to be determined by the concerned implementing office/agency or Procuring Entity and will answer for the purpose for which the ten (10%) percent retention is intended, *i.e.*, to cover uncorrected discovered defects and third party liabilities.
- 42.4. On completion of the whole Works, the Contractor may substitute retention money with an “on demand” Bank guarantee in a form acceptable to the Procuring Entity.

43. Variation Orders

- 43.1. Variation Orders may be issued by the Procuring Entity to cover any increase/decrease in quantities, including the introduction of new work items that are not included in the original contract or reclassification of work items that are either due to change of plans, design or alignment to suit actual field conditions resulting in disparity between the preconstruction plans used for purposes of bidding and the “as staked plans” or construction drawings prepared after a joint survey by the Contractor and the Procuring Entity after award of the contract, provided that the cumulative amount of the Variation Order does not exceed ten percent (10%) of the original project cost. The addition/deletion of Works should be within the general scope of the project as bid and awarded. The scope of works shall not be reduced so as to accommodate a positive Variation Order. A Variation Order may either be in the form of a Change Order or Extra Work Order.
- 43.2. A Change Order may be issued by the Procuring Entity to cover any increase/decrease in quantities of original Work items in the contract.

- 43.3. An Extra Work Order may be issued by the Procuring Entity to cover the introduction of new work necessary for the completion, improvement or protection of the project which were not included as items of Work in the original contract, such as, where there are subsurface or latent physical conditions at the site differing materially from those indicated in the contract, or where there are duly unknown physical conditions at the site of an unusual nature differing materially from those ordinarily encountered and generally recognized as inherent in the Work or character provided for in the contract.
- 43.4. Any cumulative Variation Order beyond ten percent (10%) shall be subject of another contract to be bid out if the works are separable from the original contract. In exceptional cases where it is urgently necessary to complete the original scope of work, the HoPE may authorize a positive Variation Order go beyond ten percent (10%) but not more than twenty percent (20%) of the original contract price, subject to the guidelines to be determined by the GPPB: *Provided, however,* That appropriate sanctions shall be imposed on the designer, consultant or official responsible for the original detailed engineering design which failed to consider the Variation Order beyond ten percent (10%).
- 43.5. In claiming for any Variation Order, the Contractor shall, within seven (7) calendar days after such work has been commenced or after the circumstances leading to such condition(s) leading to the extra cost, and within twenty-eight (28) calendar days deliver a written communication giving full and detailed particulars of any extra cost in order that it may be investigated at that time. Failure to provide either of such notices in the time stipulated shall constitute a waiver by the contractor for any claim. The preparation and submission of Variation Orders are as follows:
- (a) If the Procuring Entity's representative/Project Engineer believes that a Change Order or Extra Work Order should be issued, he shall prepare the proposed Order accompanied with the notices submitted by the Contractor, the plans therefore, his computations as to the quantities of the additional works involved per item indicating the specific stations where such works are needed, the date of his inspections and investigations thereon, and the log book thereof, and a detailed estimate of the unit cost of such items of work, together with his justifications for the need of such Change Order or Extra Work Order, and shall submit the same to the HoPE for approval.
 - (b) The HoPE or his duly authorized representative, upon receipt of the proposed Change Order or Extra Work Order shall immediately instruct the appropriate technical staff or office of the Procuring Entity to conduct an on-the-spot investigation to verify the need for the Work to be prosecuted and to review the proposed plan, and prices of the work involved.
 - (c) The technical staff or appropriate office of the Procuring Entity shall submit a report of their findings and recommendations, together with the supporting documents, to the Head of Procuring Entity or his duly authorized representative for consideration.

- (d) The HoPE or his duly authorized representative, acting upon the recommendation of the technical staff or appropriate office, shall approve the Change Order or Extra Work Order after being satisfied that the same is justified, necessary, and in order.
- (e) The timeframe for the processing of Variation Orders from the preparation up to the approval by the Procuring Entity concerned shall not exceed thirty (30) calendar days.

44. Contract Completion

Once the project reaches an accomplishment of ninety five (95%) of the total contract amount, the Procuring Entity may create an inspectorate team to make preliminary inspection and submit a punch-list to the Contractor in preparation for the final turnover of the project. Said punch-list will contain, among others, the remaining Works, Work deficiencies for necessary corrections, and the specific duration/time to fully complete the project considering the approved remaining contract time. This, however, shall not preclude the claim of the Procuring Entity for liquidated damages.

45. Suspension of Work

- 45.1. The Procuring Entity shall have the authority to suspend the work wholly or partly by written order for such period as may be deemed necessary, due to *force majeure* or any fortuitous events or for failure on the part of the Contractor to correct bad conditions which are unsafe for workers or for the general public, to carry out valid orders given by the Procuring Entity or to perform any provisions of the contract, or due to adjustment of plans to suit field conditions as found necessary during construction. The Contractor shall immediately comply with such order to suspend the work wholly or partly.
- 45.2. The Contractor or its duly authorized representative shall have the right to suspend work operation on any or all projects/activities along the critical path of activities after fifteen (15) calendar days from date of receipt of written notice from the Contractor to the district engineer/regional director/consultant or equivalent official, as the case may be, due to the following:
 - (a) There exist right-of-way problems which prohibit the Contractor from performing work in accordance with the approved construction schedule.
 - (b) Requisite construction plans which must be owner-furnished are not issued to the contractor precluding any work called for by such plans.
 - (c) Peace and order conditions make it extremely dangerous, if not possible, to work. However, this condition must be certified in writing by the Philippine National Police (PNP) station which has responsibility over the affected area and confirmed by the Department of Interior and Local Government (DILG) Regional Director.

- (d) There is failure on the part of the Procuring Entity to deliver government-furnished materials and equipment as stipulated in the contract.
 - (e) Delay in the payment of Contractor's claim for progress billing beyond forty-five (45) calendar days from the time the Contractor's claim has been certified to by the procuring entity's authorized representative that the documents are complete unless there are justifiable reasons thereof which shall be communicated in writing to the Contractor.
- 45.3. In case of total suspension, or suspension of activities along the critical path, which is not due to any fault of the Contractor, the elapsed time between the effectivity of the order suspending operation and the order to resume work shall be allowed the Contractor by adjusting the contract time accordingly.

46. Payment on Termination

- 46.1. If the Contract is terminated because of a fundamental breach of Contract by the Contractor, the Procuring Entity's Representative shall issue a certificate for the value of the work done and Materials ordered less advance payments received up to the date of the issue of the certificate and less the percentage to apply to the value of the work not completed, as indicated in the SCC. Additional Liquidated Damages shall not apply. If the total amount due to the Procuring Entity exceeds any payment due to the Contractor, the difference shall be a debt payable to the Procuring Entity.
- 46.2. If the Contract is terminated for the Procuring Entity's convenience or because of a fundamental breach of Contract by the Procuring Entity, the Procuring Entity's Representative shall issue a certificate for the value of the work done, Materials ordered, the reasonable cost of removal of Equipment, repatriation of the Contractor's personnel employed solely on the Works, and the Contractor's costs of protecting and securing the Works, and less advance payments received up to the date of the certificate.
- 46.3. The net balance due shall be paid or repaid within twenty eight (28) days from the notice of termination.
- 46.4. If the Contractor has terminated the Contract under **GCC** Clauses 17 or 18, the Procuring Entity shall promptly return the Performance Security to the Contractor.

47. Extension of Contract Time

- 47.1. Should the amount of additional work of any kind or other special circumstances of any kind whatsoever occur such as to fairly entitle the contractor to an extension of contract time, the Procuring Entity shall determine the amount of such extension; provided that the Procuring Entity is not bound to take into account any claim for an extension of time unless the Contractor has, prior to the expiration of the contract time and within thirty (30) calendar days after such work has been commenced or after the circumstances leading to such claim have arisen, delivered to the Procuring

Entity notices in order that it could have investigated them at that time. Failure to provide such notice shall constitute a waiver by the Contractor of any claim. Upon receipt of full and detailed particulars, the Procuring Entity shall examine the facts and extent of the delay and shall extend the contract time completing the contract work when, in the Procuring Entity's opinion, the findings of facts justify an extension.

- 47.2. No extension of contract time shall be granted the Contractor due to (a) ordinary unfavorable weather conditions and (b) inexcusable failure or negligence of Contractor to provide the required equipment, supplies or materials.
- 47.3. Extension of contract time may be granted only when the affected activities fall within the critical path of the PERT/CPM network.
- 47.4. No extension of contract time shall be granted when the reason given to support the request for extension was already considered in the determination of the original contract time during the conduct of detailed engineering and in the preparation of the contract documents as agreed upon by the parties before contract perfection.
- 47.5. Extension of contract time shall be granted for rainy/unworkable days considered unfavorable for the prosecution of the works at the site, based on the actual conditions obtained at the site, in excess of the number of rainy/unworkable days pre-determined by the Procuring Entity in relation to the original contract time during the conduct of detailed engineering and in the preparation of the contract documents as agreed upon by the parties before contract perfection, and/or for equivalent period of delay due to major calamities such as exceptionally destructive typhoons, floods and earthquakes, and epidemics, and for causes such as non-delivery on time of materials, working drawings, or written information to be furnished by the Procuring Entity, non-acquisition of permit to enter private properties or non-execution of deed of sale or donation within the right-of-way resulting in complete paralyzation of construction activities, and other meritorious causes as determined by the Procuring Entity's Representative and approved by the HoPE. Shortage of construction materials, general labor strikes, and peace and order problems that disrupt construction operations through no fault of the Contractor may be considered as additional grounds for extension of contract time provided they are publicly felt and certified by appropriate government agencies such as DTI, DOLE, DILG, and DND, among others. The written consent of bondsmen must be attached to any request of the Contractor for extension of contract time and submitted to the Procuring Entity for consideration and the validity of the Performance Security shall be correspondingly extended.

48. Price Adjustment

Except for extraordinary circumstances as determined by NEDA and approved by the GPPB, no price escalation shall be allowed. Nevertheless, in cases where the cost of the awarded contract is affected by any applicable new laws, ordinances, regulations, or other acts of the GoP, promulgated after the date of bid opening, a contract price adjustment shall be made or appropriate relief shall be applied on a no loss-no gain basis.

49. Completion

The Contractor shall request the Procuring Entity's Representative to issue a certificate of Completion of the Works, and the Procuring Entity's Representative will do so upon deciding that the work is completed.

50. Taking Over

The Procuring Entity shall take over the Site and the Works within seven (7) days from the date the Procuring Entity's Representative issues a certificate of Completion.

51. Operating and Maintenance Manuals

- 51.1. If "as built" Drawings and/or operating and maintenance manuals are required, the Contractor shall supply them by the dates stated in the **SCC**.
- 51.2. If the Contractor does not supply the Drawings and/or manuals by the dates stated in the **SCC**, or they do not receive the Procuring Entity's Representative's approval, the Procuring Entity's Representative shall withhold the amount stated in the **SCC** from payments due to the Contractor.

Section V. Special Conditions of Contract

Notes on the Special Conditions of Contract

Similar to the Section III. Bid Data Sheet, the clauses in this Section are intended to assist the Procuring Entity in providing contract-specific information in relation to corresponding clauses in the GCC.

The provisions of this Section complement the GCC, specifying contractual requirements linked to the special circumstances of the Procuring Entity, the Procuring Entity's country, the sector, and the Works procured. In preparing this Section, the following aspects should be checked:

- (a) Information that complements provisions of Section IV. General Conditions of Contract must be incorporated.
- (b) Amendments and/or supplements to provisions of Section IV. General Conditions of Contract, as necessitated by the circumstances of the specific project, must also be incorporated.

However, no special condition which defeats or negates the general intent and purpose of the provisions of Section IV. General Conditions of Contract should be incorporated herein.

For foreign-assisted projects, the Special Conditions of Contract to be used is provided in Section X-Foreign-Assisted Projects.

Section VI. Specifications

Notes on Specifications

A set of precise and clear specifications is a prerequisite for Bidders to respond realistically and competitively to the requirements of the Procuring Entity without qualifying or conditioning their Bids. In the context of international competitive bidding, the specifications must be drafted to permit the widest possible competition and, at the same time, present a clear statement of the required standards of workmanship, materials, and performance of the goods and services to be procured. Only if this is done will the objectives of economy, efficiency, and fairness in procurement be realized, responsiveness of Bids be ensured, and the subsequent task of bid evaluation facilitated. The specifications should require that all goods and materials to be incorporated in the Works be new, unused, of the most recent or current models, and incorporate all recent improvements in design and materials unless provided otherwise in the Contract.

Samples of specifications from previous similar projects are useful in this respect. The use of metric units is mandatory. Most specifications are normally written specially by the Procuring Entity or its representative to suit the Works at hand. There is no standard set of Specifications for universal application in all sectors in all regions, but there are established principles and practices, which are reflected in these PBDs.

There are considerable advantages in standardizing General Specifications for repetitive Works in recognized public sectors, such as highways, ports, railways, urban housing, irrigation, and water supply, in the same country or region where similar conditions prevail. The General Specifications should cover all classes of workmanship, materials, and equipment commonly involved in construction, although not necessarily to be used in a particular Works Contract. Deletions or addenda should then adapt the General Specifications to the particular Works.

Care must be taken in drafting specifications to ensure that they are not restrictive. In the specification of standards for goods, materials, and workmanship, recognized international standards should be used as much as possible. Where other particular standards are used, whether national standards or other standards, the specifications should state that goods, materials, and workmanship that meet other authoritative standards, and which ensure substantially equal or higher quality than the standards mentioned, will also be acceptable. The following clause may be inserted in the SCC.

Sample Clause: Equivalency of Standards and Codes

Wherever reference is made in the Contract to specific standards and codes to be met by the goods and materials to be furnished, and work performed or tested, the provisions of the latest current edition or revision of the relevant standards and codes in effect shall apply, unless otherwise expressly stated in the Contract. Where such standards and codes are national, or relate to a particular country or region, other authoritative standards that ensure a substantially equal or higher quality than the standards and codes specified will be accepted subject to the Procuring Entity's Representative's prior review and written

consent. Differences between the standards specified and the proposed alternative standards shall be fully described in writing by the Contractor and submitted to the Procuring Entity's Representative at least twenty eight (28) days prior to the date when the Contractor desires the Procuring Entity's Representative's consent. In the event the Procuring Entity's Representative determines that such proposed deviations do not ensure substantially equal or higher quality, the Contractor shall comply with the standards specified in the documents.

These notes are intended only as information for the PRO Procuring Entity or the person drafting the Bidding Documents. They should not be included in the final Bidding Documents.



REPLUBLIKA NG PILIPINAS
LUNGSOD QUEZON
CITY ENGINEERING DEPARTMENT
5TH 6TH 7TH Floors, QC Civic Center Building "B"
Telephone Nos. 8988-4242 Local 8538



20-00092

NAME OF PROJECT : PROPOSED REHABILITATION OF ROAD AND DRAINAGE AT DON PEPE STREET

LOCATION : PALMERA HOMES, BARANGAY STA. MONICA, QUEZON CITY

TECHNICAL SPECIFICATIONS

GENERAL NOTES:

1. The above-mentioned project is subject to the Standards Specifications listed herein where applicable.
2. **STANDARD SPECIFICATIONS**
All works shall comply with DPWH STANDARD SPECIFICATIONS FOR HIGHWAYS AND BRIDGES 2013 Edition supplemental specification pertaining to this project and provision of the contract.
3. **DIMENSIONS**
Unless otherwise specified, all dimensions which include stationing, distances between control points and elevations are measured in meters.
4. **ALIGNMENT AND GRADE**
No alteration or change in alignment and grade shall be made unless existing field condition so warrant and only upon the written order by the Engineer-In-charge and approved by the proper authority concerned.
5. **REMOVAL OF EXISTING STRUCTURES AND OBSTRUCTIONS**
 - a. Existing structures affected in this project shall be done with the required tools and equipment. All debris shall be immediately disposed.
 - b. Portion of existing utilities such as MWSS Pipelines, PLDT Posts, MERALCO Posts, etc. that may cause obstructions to the construction of this project shall be relocated by the entity or owner concerned. Extreme precaution shall be exercised, damaged thereof shall be the account of the contractor.
6. **SUB-GRADE, SUB BASE AND BASE.**
 - a. Unsuitable sub-grade material shall be excavated below the ground surface to the required width and depth. The area to be excavated shall be backfilled with approved material.
 - b. No embankment material shall be placed until the foundation is stable.
 - c. All aggregate sub-base and base course shall be spread, laid and compacted in accordance with the required thickness and proposed elevation.
7. **CONCRETE AND CONCRETE PAVEMENT**
 - a. All concrete to be used in this project shall be Class "A" unless otherwise indicated.
 - b. No Admixtures or additives will be allowed for all concrete works without prior approval by the City Engineer or his duly representative.
 - c. Traffic shall be required to reduced speed when passing the vicinity of the newly laid concrete pavement until such time that it has obtained the required strength.
8. **ASPHALT PAVEMENT**
 - a. Prepared or Existing Base shall be thoroughly cleaned and free from dirt by utilizing a push broom as required. Emulsified asphalt (SS1) shall be used and spread evenly on the surface prepared by utilizing an asphalt distributor as required.
 - b. Asphalt Plant Hot Mix shall be laid evenly by utilizing an asphalt paver to a thickness as required in the plan or program of work.

9. REINFORCING STEEL BARS

Reinforcing steel shall conform to AASHTO M31 (ASTM615), Grade 40 for Bars 16 mm. diameter and smaller (40,000 psi), $f_y = 275$ MPa, and for Bars greater than 16 mm Diam., Grade 60 (60,000 psi) $f_y = 414$ MPa.

20-00092

10. DRAINAGE

- a. Exact location, slope, outfalls and invert elevation of drainage structures shall be checked in the field by the Engineer-In-Charge, minor adjustment maybe made by the approval of the Engineer to suit actual field condition.
- b. Existing drainage structures or part thereof removed by the contractor that are still serviceable shall be turned over to the Government and shall be deposited at a place within the project site designated by the Engineer-In-Charge without any extra compensation. Extreme precaution shall be exercised by the contractor not to damage these materials during the removal and handling.

11. CONSTRUCTION STAKES

- a. The contractor will be responsible for the true and proper setting out of the work or improvement and for correctness of position, level slope and continuous profile grade in road work. He will set construction stakes, establishing lines, slope and continuous profile work and other line and benchmark for bridge work.

Grade in road protective and necessary structures and appurtenances culvert work, as are deemed necessary from the reference date to be furnished by the Engineer-In-Charge in writing.

- b. The checking of construction stakes by the Engineer-In-Charge shall not in any way relieve the contractor of his responsibility for the correctness thereof and the contractor shall carefully protect preserve all benchmark, pegs and other things used in setting out of the work.

ITEM 104 – REMOVAL OF EXISTING STRUCTURES**DESCRIPTION**

This Item shall consist of the removal wholly or in part, and satisfactory disposal of all buildings, fences, structures, old pavements, abandoned pipe lines, and any other obstructions which are not designated or permitted to remain, except for the obstructions to be removed and disposed off under other items in the Contract. It shall also include the salvaging of designated materials and backfilling the resulting trenches, holes, and pits.

ITEM 105 – ROADWAY EXCAVATION**DESCRIPTION**

Roadway excavation will include excavation and grading for roadways, parking areas, intersections, approaches, slope rounding, benching, waterways and ditches; removal of unsuitable material from the roadbed and beneath embankment areas; and excavating selected material found in the roadway as ordered by the Engineer for specific use in the improvement.

ITEM 106 – EXCAVATION FOR STRUCTURES**DESCRIPTION**

This item shall consist of the necessary excavation for reinforced concrete pipes, lined canal, box culverts and other structures not otherwise provided for in the Specifications. Except as otherwise provided for pipe culverts, the backfilling of completed structures and the disposal of all excavated materials shall be in accordance with this specification and in reasonably close conformity with the Plans or as established by the Engineer-In-Charge. This Item shall include necessary diverting of live streams, bailing, pumping, draining, sheeting, bracing, and the necessary construction of cribs and cofferdams, and furnishing the materials therefore, and the subsequent removal of cribs and cofferdams and the placing of all necessary backfill. It shall also include the furnishing and placing of approved foundation fill material to replace unsuitable material encountered below the foundation elevation of structures.

ITEM 200 – AGGREGATE BASE COURSE
DESCRIPTION

This Item shall consist of furnishing, placing and compacting an aggregate base course on a prepared subgrade/subbase in accordance with this Specification and the lines, grades, thickness and typical cross-sections shown on the Plans, or as established by the Engineer-In-charge.

MATERIAL REQUIREMENTS

20-00092

Aggregate for base course shall consist of hard, durable particles or fragments of crushed stone, crushed slag or crushed or natural gravel and filler of natural or crushed sand or other finely divided mineral matter. The composite material shall be free from vegetable matter and lumps or balls of clay, and shall be of such nature that it can be compacted readily to form a firm, stable base. In some areas where the conventional base course materials are scarce or non-available, the use of 40% weathered limestone blended with 60% crushed stones or gravel shall be allowed, provided that the blended materials meet the requirements of this Item. The base course material shall conform to Table 201.1, whichever is called for in the Bill of Quantities.

Table 201.1 - Grading Requirements

Sieve Designation		Mass Percent Passing	
Standard, mm	Alternate US Standard	Grading A	Grading B
50	2'	100	
37.5	1-1/2'	-	100
25.0	1"	60 - 85	-
19.0	3/4"	-	60 - 85
12.5	1/2"	35 - 65	-
4.75	No. 4	20 - 50	30 - 55
0.425	No. 40	5 - 20 0 -	8 - 25 2
0.075	No. 200	12	- 14

The fraction passing the 0.075 mm (No. 200) sieve shall not be greater than 0.66 (two thirds) of the fraction passing the 0.425 mm (No. 40) sieve.

The fraction passing the 0.425 mm (No. 40) sieve shall have a liquid limit not greater than 25 and plasticity index not greater than 6 as determined by AASHTO T 89 and T 90, respectively. The coarse portion, retained on a 2.00 mm (No. 10) sieve shall have a mass percent of wear not exceeding 50 by the Los Angeles Abrasion test determined by AASHTO T 96. The material passing the 19 mm (3/4 inch) sieve shall have a soaked CBR value of not less than 80% as determined by AASHTO T 193. The CBR value shall be obtained at the maximum dry density (MDD) as determined by AASHTO T 180, Method D. If filler, in addition to that naturally present, is necessary for meeting the grading requirements or for satisfactory bonding, it shall be uniformly blended with the base course material on the road or in a pug mill unless otherwise specified or approved. Filler shall be taken from sources approved by the Engineer, shall be free from hard lumps and shall not contain more than 15 percent of material retained on the 4.75 mm (No. 4) sieve.

ITEM 316 – PORTLAND CEMENT CONCRETE PAVEMENT
DESCRIPTION

This Item shall consist of pavement of Portland Cement Concrete, with or without reinforcement, constructed on the prepared base in accordance with this Specification and in conformity with lines, grades, thickness and typical cross-section shown on the Plans. Compressive strength for concrete mix to be used shall not be less than 4,000 psi.

MATERIAL REQUIREMENTS

PORTLAND CEMENT

It shall conform to the applicable requirements of Item 700, Hydraulic Cement. Only Type I Portland Cement shall be used unless otherwise provided for in the Special Provisions. Different brands or the

same brands from different mills shall not be mixed nor shall they be used alternately unless the mix is approved by the Engineer. However, the use of Portland Pozzolana Cement Type IP meeting the requirements of AASHTO M 240/ASTM C 695, Specifications for Blended Hydraulic Cement shall be allowed, provided that trial mixes shall be done and that the mixes meet the concrete strength requirements, the AASHTO/ASTM provisions pertinent to the use of Portland Pozzolana Type IP shall be adopted. Cement which for any reason, has become partially set or which contains lumps of caked cement shall be rejected. Samples of cement shall be obtained in accordance with AASHTO T 127.

20-00092

FINE AGGREGATES

It shall consist of natural sand, stone screenings or other inert materials with similar characteristics, or combinations thereof, having hard, strong and durable particles. Fine aggregate from different sources of supply shall not be mixed or stored in the same pile nor used alternately in the same class of concrete without the approval of the Engineer.

It shall not contain more than three (3) mass percent of material passing the 0.075 mm (No. 200 sieve) by washing nor more than one (1) mass percent each of clay lumps or shale. The use of beach sand will not be allowed without the approval of the Engineer.

If the fine aggregate is subjected to five (5) cycles of the sodium sulfate soundness test, the weighted loss shall not exceed 10 mass percent.

The fine aggregate shall be free from injurious amounts of organic impurities. If subjected to the colorimetric test for organic impurities and a color darker than the standard is produced, it shall be rejected. However, when tested for the effect of organic impurities of strength of mortar by AASHTO T 71, the fine aggregate may be used if the relative strength at 7 and 28 days is not less than 95 mass percent.

The fine aggregate shall be well-graded from coarse to fine and shall conform to Table 311.1

Table 311.1 - Grading Requirements for Fine Aggregate

Sieve Designation	Mass Percent Passing
9.5 mm (3/8 in)	100
4.75 mm (No. 4)	95 - 100
2.36 mm (No. 8)	-
1.18 mm (No. 16)	45 - 80
0.600 mm (No. 30)	-
0.300 mm (No. 50)	5 - 30 -
0.150 mm (No. 100)	10

COARSE AGGREGATES

It shall consist of crushed stone, gravel, blast furnace slag, or other approved inert materials of similar characteristics, or combinations thereof, having hard, strong, durable pieces and free from any adherent coatings.

It shall contain not more than one (1) mass percent of material passing the 0.075 mm (No. 200) sieve, not more than 0.25 mass percent of clay lumps, nor more than 3.5 mass percent of soft fragments.

If the coarse aggregate is subjected to five (5) cycles of the sodium sulfate soundness test, the weighted loss shall not exceed 12 mass percent.

It shall have a mass percent of wear not exceeding 40 when tested by AASHTO T 96.

If the slag is used, its density shall not be less than 1120 kg/m³ (70 lb./cu. ft.). The gradation of the coarse aggregate shall conform to Table 311.2.

Only one grading specification shall be used from any one source.

Table 311.2 - Grading Requirement for Coarse Aggregate

20 - 00092

Sieve Designation		Mass Percent Passing		
Standard Mm	Alternate U. S. Standard	Grading A	Grading B	Grading C
75.00	3 in.	100	-	-
63.00	2-1/2 in.	90-100	100	100
50.00	2 in.	- 90-100	95-100 37.5	1-1/2 in.
	25-60	35-70	-	
25.0	1 in.	- 0-15	35-70 19.0	3/4 in.
	0-10	- -		
12.5	1/2 in.	0-5	0-5	10-30
4.75	No. 4	-	-	0-5

WATER

Water used in mixing, curing or other designated application shall be reasonably clean and free of oil, salt, acid, alkali, grass or other substances injurious to the finished product. Water will be tested in accordance with and shall meet the requirements of Item 714, Water. Water which is drinkable may be used without test. Where the source of water is shallow, the intake shall be so enclosed as to exclude silt, mud, grass or other foreign materials.

REINFORCING STEEL

It shall conform to the requirements of Item 404, Reinforcing Steel. Dowels and tie bars shall conform to the requirements of AASHTO M 31 or M 42, except that rail steel shall not be used for tie bars that are to be bent and straightened during construction. Tie bars shall be deformed bars. Dowels shall be plain round bars. Before delivery to the site of work, one-half of the length of each dowel shall be painted with one coat of approved lead or tar paint. The sleeves for dowel bars shall be metal of approved design to cover 50 mm (2 inches), plus or minus 5 mm (1/4 inch) of the dowel, with a closed end, and with a suitable stop to hold the end of the sleeve at least 25 mm (1 inch) from the end of the dowel. Sleeves shall be of such design that they do not collapse during construction.

JOINT FILLERS

Poured joint fillers shall be mixed asphalt and mineral or rubber filler conforming to the applicable requirements of Item 705, Joint Materials.

Preformed joint filler shall conform to the applicable requirements of Item 705. It shall be punched to admit the dowels where called for in the Plans. The filler for each joint shall be furnished in a single piece for the full depth and width required for the joint.

ADMIXTURES

Air-entraining admixture shall conform to the requirements of AASHTO M 154. Chemical admixtures, if specified or permitted, shall conform to the requirements of AASHTO M 194. Fly Ash, if specified or permitted as a mineral admixture and as 20% partial replacement of Portland Cement in concrete mix shall conform to the requirements of ASTM C 618. Admixture should be added only to the concrete mix to produce some desired modifications to the properties of concrete where necessary, but not as partial replacement of cement.

CURING MATERIALS

Curing materials shall conform to the following requirements as specified;

- a) Burlap cloth - AASHTO M 182
 - b) Liquid membrane forming compounds - AASHTO M 148
 - c) Sheeting (film) materials - AASHTO M 171
- Cotton mats and water-proof paper can be used.

CALCIUM CHLORIDE/CALCIUM NITRATE

It shall conform to AASHTO M 144, if specified or permitted by the Engineer-in-charge, as accelerator.

STORAGE OF CEMENT AND AGGREGATE

All cement shall be stored, immediately upon delivery at the Site, in weatherproof building which will

protect the cement from dampness. The floor shall be raised from the ground. The buildings shall be placed in locations approved by the Engineer. Provisions for storage shall be ample, and the shipments of cement as received shall be separately stored in such a manner as to allow the earliest deliveries to be used first and to provide easy access for identification and inspection of each shipment. Storage buildings shall have capacity for storage of a sufficient quantity of cement to allow sampling at least twelve (12) days before the cement is to be used. Bulk cement, if used, shall be transferred to elevated air tight and weatherproof bins. Stored cement shall meet the test requirements at any time after storage when retest is ordered by the Engineer-in-charge. At the time of use, all cement shall be free-flowing and free of lumps. The handling and storing of concrete aggregates shall be such as to prevent segregation or the inclusion of foreign materials. The Engineer may require that aggregates be stored on separate platforms at satisfactory locations. In order to secure greater uniformity of concrete mix, the Engineer may require that the coarse aggregate be separated into two or more sizes. Different sizes of aggregate shall be stored in separate bins or in separate stockpiles sufficiently removed from each other to prevent the material at the edges of the piles from becoming intermixed.

PROPORTIONING, CONSISTENCY AND STRENGTH OF CONCRETE

The Contractor shall prepare the design mix based on the absolute volume method as outlined in the American Concrete Institute (ACI) Standard 211.1, "Recommended Practice for Selecting Proportions for Normal and Heavyweight Concrete". It is the intent of this Specification to require at least 364 kg of cement per cubic meter of concrete to meet the minimum strength requirements. The Engineer shall determine from laboratory tests of the materials to be used, the cement content and the proportions of aggregate and water that will produce workable concrete having a slump of between 40 and 75 mm (1-1/2 and 3 inches) if not vibrated or between 10 and 40 mm (1/2 and 1-1/2 inches) if vibrated, and a flexural strength of not less than 3.8 MPa (550 psi) when tested by the third-point method or 4.5 MPa (650 psi) when tested by the mid-point method at fourteen (14) days in accordance with AASHTO T97 and T177, respectively; or a compressive strength of 24.1 MPa (3500 psi) for cores taken at fourteen (14) days and tested in accordance with AASHTO T24. Slump shall be determined using AASHTO T 119. The designer shall consider the use of lean concrete (econocrete) mixtures using local materials or specifically modified conventional concrete mixes in base course and in the lower course composite, monolithic concrete pavements using a minimum of 75 mm (3 inches) of conventional concrete as the surface course. The mix design shall be submitted to the Engineer for approval and shall be accompanied with certified test data from an approved laboratory demonstrating the adequacy of the mix design. A change in the source of materials during the progress of work may necessitate a new design mix.

ITEM 413 - PIPE CULVERT AND STORM DRAINS

DESCRIPTION

This item shall consist of the construction or reconstruction of pipe culverts and storm drains, hereinafter referred to as "conduit" in accordance with this Specification and in conformity with the lines and grades shown on the Plans or as established by the Engineer.

MATERIAL REQUIREMENTS

Material shall meet the requirements specified in the following specifications:

Zinc coated (galvanized) corrugated iron or steel culverts and underdrains	AASHTO M 36
Cast iron culvert pipe	AASHTO M64
Concrete sewer, storm drain and culvert pipe	AASHTO M 86
Reinforced concrete culvert, storm drain and sewer pipe	AASHTO M 170
Bituminous coated corrugated metal culvert pipe and pipe arches	AASHTO M 190
Reinforced concrete arch culvert, storm drain and sewer pipe	AASHTO M 206
Reinforced concrete elliptical culvert, storm drain and sewer pipe	AASHTO M 207
Asbestos cement pipe for culverts and storm drains	AASHTO M 217

JOINT MORTAR

Joint mortar for concrete pipes shall consist of 1 part, by volume of Portland Cement and two (2) parts of approved sand with water as necessary to obtain the required consistency. Portland Cement and sand shall conform to the requirements of Item 405, Structural Concrete. Mortar shall be used within 30 minutes after its preparation.

20-00092

Rubber gaskets	AASHTO M 198
----------------	--------------

OAKUM

Oakum for joints in bell and spigot pipes shall be made from hemp (*Cannabis Sativa*) line or Benares Sunn fiber or from a combination of these fibers. The oakum shall be thoroughly corded and finished and practically free from lumps, dirt and extraneous matter.

Hot poured joint sealing compound	AASHTO M 173
-----------------------------------	--------------

Bedding material shall conform to the requirements of Subsection 500.3.2, Bedding. Backfill material shall conform to the requirements of Subsection 500.3.6, Backfilling. When the location of manufacturing plants allows, the plants will be inspected periodically for compliance with specified manufacturing methods, and material samples will be obtained for laboratory testing for compliance with materials quality requirements. This shall be the basis for acceptance of manufacturing lots as to quality. Prior to and during incorporation of materials in the work, these materials will be subjected to the latest inspection and approval of the Engineer.

ITEM 502 – CONCRETE CURB AND GUTTER
DESCRIPTION

This Item shall consist of the construction of curb and gutter either Precast or Cast in place, made of concrete in accordance with this Specification at the location, and in conformity with the lines, grades, dimensions and design, shown on the Plans or as required by the Engineer-in-charge.

MATERIAL REQUIREMENTS**MATERIAL FOR BED COURSE**

Bed course materials as shown on the Plans shall consist of cinders, sand, slag, gravel, crushed stone, or other approved porous material of such grading that all the particles will pass through 12.5 mm (1/2 inch) sieve.

CONCRETE

Concrete shall be of the class indicated on the Plans and shall conform to the requirements of Item 405, Structural Concrete.

EXPANSION JOINT FILLER

Expansion joint filler shall conform to the requirements of AASHTO M 153/joint materials.

CEMENT MORTAR

Cement mortar shall consist of one part of Portland cement and two parts of fine aggregates with water added as necessary to obtain the required consistency. The mortar shall be used within 30 minutes of preparation.

BONDING COMPOUND

Where bonding compound is used, it shall conform to AASHTO M 200.

FORMS

Forms shall be of wood or metal as approved by the Engineer and shall extend to the full depth of the concrete. All forms shall be straight, free from warps and of adequate strength to resist distortion.

ITEM 503 – CONCRETE SIDEWALK
DESCRIPTION

This Item shall consist of the construction of asphalt or Portland Cement concrete sidewalk in accordance with this Specification and to the lines, grades, levels and dimensions shown on the Plans, or as required by the Engineer-in-charge.

MATERIAL REQUIREMENTS

PORTLAND CEMENT CONCRETE

The cement concrete shall be Class A as specified in Item 405, Structural Concrete.

20-00092

ASPHALT

Asphaltic material shall be as specified in Item 308, Bituminous Plant-Mix Surface Course, Cold-Laid, or Item 310, Bituminous Concrete Surface Course, Hot-Laid.

EXPANSION JOINT FILLER

Unless otherwise ordered, the preformed joint filler shall have a thickness of 5 mm and shall conform to the requirements of Item 311, Portland Cement Concrete Pavement.

FORMS

Forms shall be of wood or metal as approved by the Engineer and shall extend to the full depth of the concrete. All forms shall be straight, free from warps and of adequate strength to resist distortion.

BED COURSE MATERIAL

Bed course material consists of cinders, sand, slag, gravel, crushed stone or other approved permeable granular material of such grading that all particles shall pass a 12.5 mm (1/2 inch) sieve.

ASPHALTIC PRIME COAT

Prime coat shall be cut-back asphalt conforming to the requirements of Item 301, Bituminous Prime Coat.

ITEM SPL1 – CMH WITH AB AND CAST IRON (Rdwy.)
DESCRIPTION

This item shall consist of construction of manholes and inlets in accordance with the Standard Specifications for Public Works and Highways and in reasonably close conformity with the lines and grades shown on the plans or as established by the Engineer-In-Charge.

MATERIAL REQUIREMENTS

Concrete for these structures shall meet the requirements of Item 405, Structural Concrete. Other materials shall meet the following specifications:

CORRUGATED METAL UNITS

The units shall conform to Plan dimensions and the metal to AASHTO M 36. Bituminous coating, when specified, shall conform to ASTM D 1187, Asphalt-base Emulsion for use as Protective Coating for Metal.

Sewer and manhole brick (Made from clay or shale)	AASHTO M 91
Building brick (Solid masonry units made from clay or shale)	AASHTO M 114

JOINT MORTAR

Unless otherwise indicated on the Plans, joints mortar shall be composed of one part Portland Cement and two parts fine aggregate by volume to which hydrated lime has been added in an amount equal to 10 percent of the cement by weight. All materials for mortar shall meet the requirements of Item 405, Structural Concrete.

FRAMES, GRATINGS, COVERS AND LADDER RUNGS

Metal units shall conform to the plan dimensions and to the following specification requirements for the designated materials. Metal gratings and covers which are to rest on frames shall bear on them evenly. They shall be assembled before shipment and so marked that the same pieces may be reassembled

readily in the same position when installed. Inaccuracy of bearings shall be corrected by machining, if necessary. A frame and a grating or cover to be used with it shall constitute one pair.

All castings shall be uniformly coated with asphalt-based emulsion meeting the requirements of ASTM D 1187, Asphalt-base Emulsion for use as Protective Coating for Metal. Samples of the material in casting shall be taken during the casting of the units and shall be separate casting poured from the same material as the casting they represent

Gray iron casting	AASHTO M 105
Mild to medium-strength carbon steel castings for general application	AASHTO M 103
Structural steel	AASHTO M 183
Galvanizing, where specified for these units, shall conform to the requirements of	AASHTO M 111
Reinforcing Steel	AASHTO M 31

0-00092

PRE-CAST CONCRETE UNITS

These units shall be cast in substantial permanent steel forms. Structural concrete used shall attain a minimum 28-day compressive strength of 20.682 MPa (3000 psi). The pre-cast units shall be cured in accordance with AASHTO M 171. Water absorption of individual cores taken from such units shall not exceed 7 percent. Additional reinforcement shall be provided as necessary to provide for handling of the pre-cast units. A sufficient number of cylinders shall be cast from the concrete for each unit permit compression tests at 7, 14 and 28 days, and to allow for at least 3 cylinders for each test. If the strength requirement is met at 7 or 14 days, the units shall be certified for use 14 days from the date of casting. If the strength is not met at 28 days, all units made from that batch or load will be rejected. Cracks in units, honeycombed or patched areas in excess of 2,000 square millimeters, excessive water absorption and failure to meet strength requirements shall be the causes for rejection. Pre-cast reinforced concrete manhole risers and tops shall conform to the requirements of AASHTO M 199. The plants will be inspected periodically for compliance with specified manufacturing methods, and material samples will be obtained for laboratory testing for compliance with material quality requirements. This may be the basis for acceptance of manufacturing lots as the quality. All materials shall be subjected to inspection for acceptance as to condition at the latest practicable time the Engineer has the opportunity to check for compliance prior to or during incorporation of materials into the work.

ITEM SPL 4 – BARRICADE FOR EXCAVATION & MH WITH CAUTION TAPE DESCRIPTION

This item shall consist of furnishing, placing and finishing concrete and reinforcing bars in all structures of the concrete barricade in conformity to the lines, grades, and dimensions shown on the Plans. Compressive strength of concrete shall be 4000 psi and reinforcing steel bars shall not be less than Grade 60.

MATERIAL REQUIREMENTS

PORTLAND CEMENT

It shall conform to the applicable requirements of AASHTO M 85, Hydraulic Cement. Only Type I Portland Cement shall be used unless otherwise provided for in the Special Provisions. Different brands or the same brands from different mills shall not be mixed nor shall they be used alternately unless the mix is approved by the Engineer. Cement which for any reason, has become partially set or which contains lumps of caked cement shall be rejected. Samples of cement shall be obtained in accordance with AASHTO T 127.

FINE AGGREGATES

It shall consist of natural sand, stone screenings or other inert materials with similar characteristics, or combinations thereof, having hard, strong and durable particles. Fine aggregate from different sources of supply shall not be mixed or stored in the same pile nor used alternately in the same class of concrete

without the approval of the Engineer.

It shall not contain more than three (3) mass percent of material passing the 0.075 mm (No. 200 sieve) by washing nor more than one (1) mass percent each of clay lumps or shale. The use of beach sand will not be allowed without the approval of the Engineer.

If the fine aggregate is subjected to five (5) cycles of the sodium sulfate soundness test, the weighted loss shall not exceed 10 mass percent.

The fine aggregate shall be free from injurious amounts of organic impurities. If subjected to the colorimetric test for organic impurities and a color darker than the standard is produced, it shall be rejected. However, when tested for the effect of organic impurities of strength of mortar by AASHTO T 71, the fine aggregate may be used if the relative strength at 7 and 28 days is not less than 95 mass percent.

The fine aggregate shall be well-graded from coarse to fine and shall conform to Table 311.1 **20-00092**

Table 311.1 - Grading Requirements for Fine Aggregate

Sieve Designation	Mass Percent Passing
9.5 mm (3/8 in)	100
4.75 mm (No. 4)	95 - 100
2.36 mm (No. 8)	-
1.18 mm (No. 16)	45 - 80
0.600 mm (No. 30)	-
0.300 mm (No. 50)	5 - 30 -
0.150 mm (No. 100)	10

COARSE AGGREGATES

It shall consist of crushed stone, gravel, blast furnace slag, or other approved inert materials of similar characteristics, or combinations thereof, having hard, strong, durable pieces and free from any adherent coatings.

It shall contain not more than one (1) mass percent of material passing the 0.075 mm (No. 200) sieve, not more than 0.25 mass percent of clay lumps, nor more than 3.5 mass percent of soft fragments.

If the coarse aggregate is subjected to five (5) cycles of the sodium sulfate soundness test, the weighted loss shall not exceed 12 mass percent.

It shall have a mass percent of wear not exceeding 40 when tested by AASHTO T 96.

If the slag is used, its density shall not be less than 1120 kg/m³ (70 lb./cu. ft.). The gradation of the coarse aggregate shall conform to Table 311.2.

Only one grading specification shall be used from any one source.

Table 311.2 - Grading Requirement for Coarse Aggregate

Sieve Designation		Mass Percent Passing		
Standard Mm	Alternate U.S. Standard	Grading A	Grading B	Grading C
75.00	3 in.	100	-	-
63.00	2-1/2 in.	90-100	100	100
50.00	2 in.	- 90-100	95-100 37.5	1-1/2 in.
	25-60	35-70	-	
25.0	1 in.	- 0-15	35-70 19.0	3/4 in.
	0-10	- -		
12.5	1/2 in.	0-5	0-5	10-30
4.75	No. 4	-	-	0-5

WATER

Water used in mixing, curing or other designated application shall be reasonably clean and free of oil, salt, acid, alkali, grass or other substances injurious to the finished product. Water will be tested in accordance with and shall meet the requirements of Item 714, Water. Water which is drinkable may be used without test. Where the source of water is shallow, the intake shall be so enclosed as to exclude silt, mud, grass or other foreign materials.

REINFORCING STEEL

20 - 00092

It shall conform to the requirements of Item 404, Reinforcing Steel. Dowels and tie bars shall conform to the requirements of AASHTO M 31 or M 42, except that rail steel shall not be used for tie bars that are to be bent and straightened during construction. Tie bars shall be deformed bars. Dowels shall be plain round bars. Before delivery to the site of work, one-half of the length of each dowel shall be painted with one coat of approved lead or tar paint. The sleeves for dowel bars shall be metal of approved design to cover 50 mm (2 inches), plus or minus 5 mm (1/4 inch) of the dowel, with a closed end, and with a suitable stop to hold the end of the sleeve at least 25 mm (1 inch) from the end of the dowel. Sleeves shall be of such design that they do not collapse during construction.

ADMIXTURES

Air-entraining admixture shall conform to the requirements of AASHTO M 154. Chemical admixtures, if specified or permitted, shall conform to the requirements of AASHTO M 194. Fly Ash, if specified or permitted as a mineral admixture and as 20% partial replacement of Portland Cement in concrete mix shall conform to the requirements of ASTM C 618. Admixture should be added only to the concrete mix to produce some desired modifications to the properties of concrete where necessary, but not as partial replacement of cement. If specified, monofilament polypropylene synthetic fibrin fibers, which are used as admixture to prevent the formation of temperature/shrinkage cracks and increase impact resistance of concrete slabs shall be applied in the dosage rate recommended by its manufacturer.

STORAGE OF CEMENT AND AGGREGATE

All cement shall be stored, immediately upon delivery at the Site, in weatherproof building which will protect the cement from dampness. The floor shall be raised from the ground. The buildings shall be placed in locations approved by the Engineer. Provisions for storage shall be ample, and the shipments of cement as received shall be separately stored in such a manner as to allow the earliest deliveries to be used first and to provide easy access for identification and inspection of each shipment. Storage buildings shall have capacity for storage of a sufficient quantity of cement to allow sampling at least twelve (12) days before the cement is to be used. Bulk cement, if used, shall be transferred to elevated air tight and weatherproof bins. Stored cement shall meet the test requirements at any time after storage when retest is ordered by the Engineer-in-charge. At the time of use, all cement shall be free-flowing and free of lumps. The handling and storing of concrete aggregates shall be such as to prevent segregation or the inclusion of foreign materials. The Engineer may require that aggregates be stored on separate platforms at satisfactory locations. In order to secure greater uniformity of concrete mix, the Engineer may require that the coarse aggregate be separated into two or more sizes. Different sizes of aggregate shall be stored in separate bins or in separate stockpiles sufficiently removed from each other to prevent the material at the edges of the piles from becoming intermixed.

FORM LUMBER

It shall be specified on the plans. It shall be free from loose knots, splits, worn holes, decay, warp, ring separation, or any defects which will impair its strength or render it unfit for its intended use.

ITEM SPL5 – TAPPING DRAINAGE DESCRIPTION

This item shall consist of tapping of affected drainage systems of houses and other building structures within the road-right-of-way in conformity with the Standard Specifications for Public Works and Highways and on location as shown on the plans.

MATERIAL REQUIREMENTS

JOINT MORTAR

Joint mortar for concrete pipes shall consist of one-part, by volume of Portland Cement and two-parts of approved sand with water as necessary to obtain the required consistency. Mortar shall be used within 30 minutes after its preparation

PORTLAND CEMENT

It shall conform to the applicable requirements of AASHTO M 85, Hydraulic Cement. Only Type I Portland Cement shall be used unless otherwise provided for in the Special Provisions. Different brands or the same brands from different mills shall not be mixed nor shall they be used alternately unless the mix is approved by the Engineer-in-charge. Cement which for any reason, has become partially set or which contains lumps of caked cement shall be rejected. Cement salvaged from the discarded or used bags shall not be used. Samples of cement shall be obtained in accordance with AASHTO T 127.

FINE AGGREGATES

20-00092

It shall consist of natural sand, stone screenings or other inert materials with similar characteristics, or combinations thereof, having hard, strong and durable particles. Fine aggregate from different sources of supply shall not be mixed or stored in the same pile nor used alternately in the same class of concrete without the approval of the Engineer.

It shall not contain more than three (3) mass percent of material passing the 0.075 mm (No. 200 sieve) by washing nor more than one (1) mass percent each of clay lumps or shale. The use of beach sand will not be allowed without the approval of the Engineer.

If the fine aggregate is subjected to five (5) cycles of the sodium sulfate soundness test, the weighted loss shall not exceed 10 mass percent.

The fine aggregate shall be free from injurious amounts of organic impurities. If subjected to the colorimetric test for organic impurities and a color darker than the standard is produced, it shall be rejected. However, when tested for the effect of organic impurities of strength of mortar by AASHTO T 71, the fine aggregate may be used if the relative strength at 7 and 28 days is not less than 95 mass percent.

The fine aggregate shall be well-graded from coarse to fine and shall conform to Table 311.1

Table 311.1 - Grading Requirements for Fine Aggregate

Sieve Designation	Mass Percent Passing
9.5 mm (3/8 in)	100
4.75 mm (No. 4)	95 - 100
2.36 mm (No. 8)	-
1.18 mm (No. 16)	45 - 80
0.600 mm (No. 30)	-
0.300 mm (No. 50)	5 - 30 -
0.150 mm (No. 100)	10

This item shall consist of repair of any MWSS/NAWASA lines that would be affected in excavation of roadway in accordance with the MWSS Standard Specification.

Based on MWSS MATERIAL REQUIREMENTS

ITEM SPL 7 – BILLBOARD**DESCRIPTION**

This item shall consist of installation of Billboards on locations as established by the Engineer-In-Charge in conformity with the standard size, design, layout and dimension as shown in the Plans.

MATERIAL REQUIREMENTS

Based on the standard design approved by and material requirement of the implementing agency.

ITEM SPL 10a/10b – THERMOPLASTIC MARKINGS (WHITE/YELLOW)**MATERIAL REQUIREMENTS**

Reflectorized thermoplastic pavement material shall be homogeneously composed of pigment, filler, resins, and glass reflectorizing spheres.

The thermoplastic materials shall be available to both white and yellow.

Glass Beads (Pre-mix) shall be uncoated and shall comply with the following requirements:

Refractive Index, min. – 1.5
Spheres Percent, min. – 90

Gradation:

Sieve, mm	Mass Percent Passing
0.850	100
0.600	75 – 95
0.425	-
0.300	15 – 35
0.180	-
0.150	0 – 5

ITEM SPL 12 CONSTRUCTION SAFETY AND HEALTH
DESCRIPTION

20-00092

This item shall include necessary provision of construction safety and health gear such as safety vest, Safety helmet, First Aid Kit, Safety Boots and Gloves. All materials delivered and utilized for the project shall be turned-over to the Implementing agency after the completion of the project.

MATERIAL REQUIREMENTS

Based on the standard design and specifications approved by and material requirement of the implementing agency.

NOTES:

All other item of works not covered by this listed TECHNICAL SPECIFICATIONS shall be ISSUED with supplemental specifications by the Implementing Agency based on the Program of Work and Approved Plan(s) for the proposed project.

PREPARED BY:



ANDRAE RENZ B. LEE
Planning and Programming Division

CHECKED BY:

MARILEN F. COMENDADOR
Planning and Programming Division

Section VII. Drawings

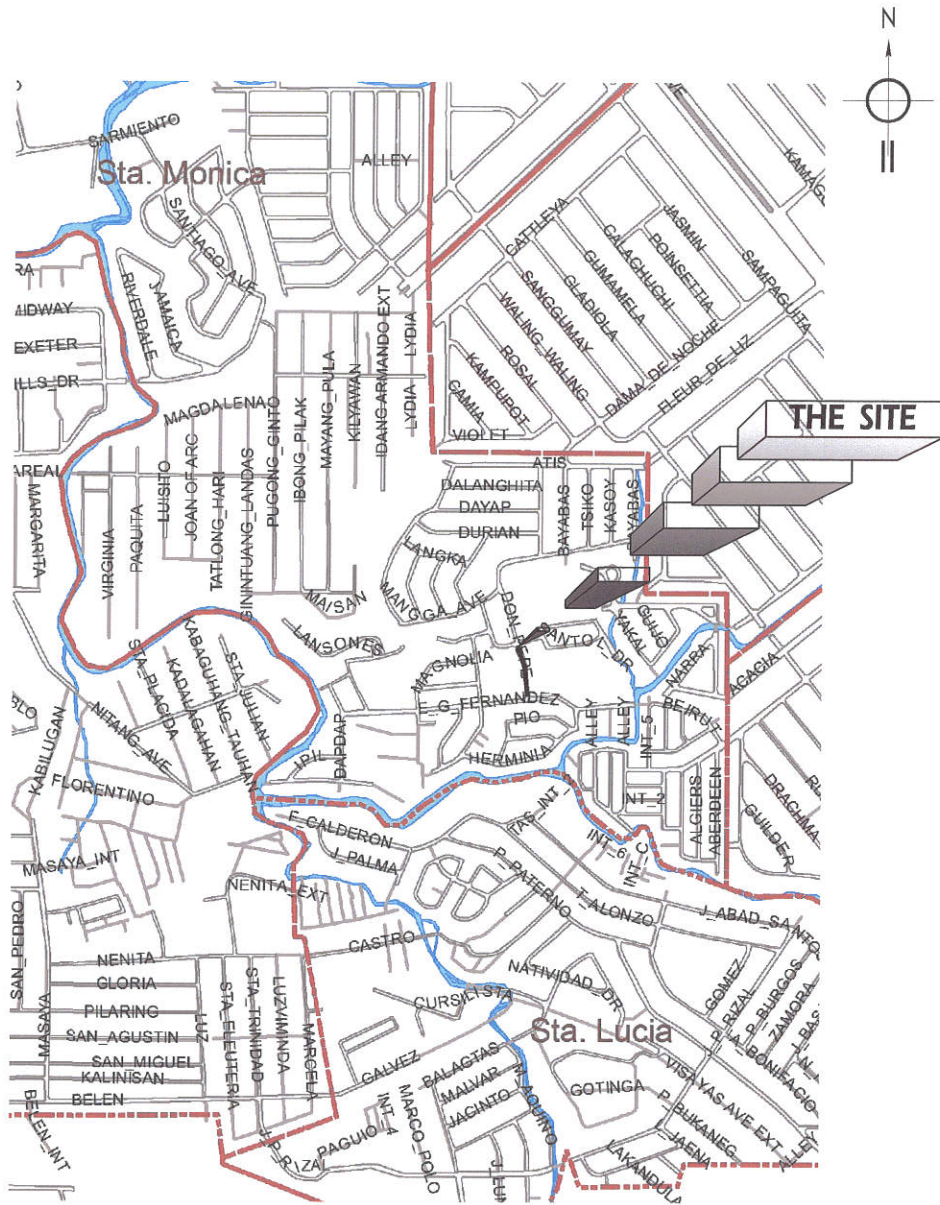
Insert here a list of Drawings. The actual Drawings, including site plans, should be attached to this section or annexed in a separate folder.



1 VICINITY MAP

SCALE : NOT TO SCALE

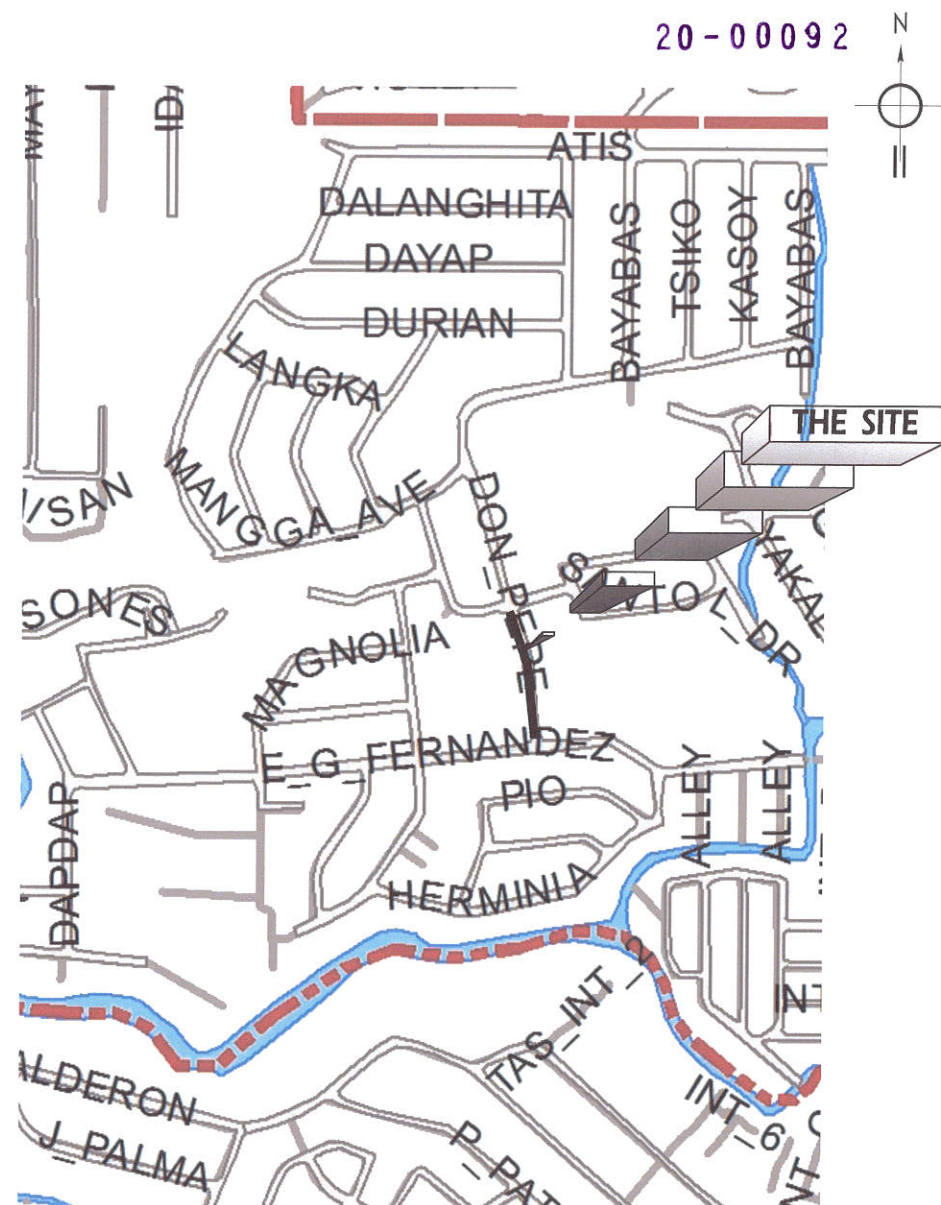

2 LOCATION MAP

SCALE : NOT TO SCALE



Republika ng Pilipinas
Lungsod ng Quezon
CITY ENGINEERING DEPARTMENT

PROJECT TITLE :

**PROPOSED REHABILITATION OF
ROAD AND DRAINAGE AT
DON PEPE STREET**

LOCATION:
BARANGAY STA. MONICA, DISTRICT 5, QUEZON CITY

DRAWN BY: JPCG

DATE: SEPT. 30, 2020

CHECKED BY: *[Signature]*

REVISION NO.:

SUBMITTED BY:

[Signature]
ENGR. LEO S. DEL ROSARIO
HEAD, PLANNING & PROGRAMMING DIVISION

RECOMMENDING APPROVAL:

[Signature]
ENGR. SAGANI R. VERZOSA, JR.
CITY ENGINEERING DEPARTMENT

APPROVED BY:

[Signature]
HON. MA. JOSEFINA G. BELMONTE
CITY MAYOR, QUEZON CITY

SHEET CONTENT

VICINITY MAP
LOCATION MAP

SHEET NO.

**CW
01**

20-00092

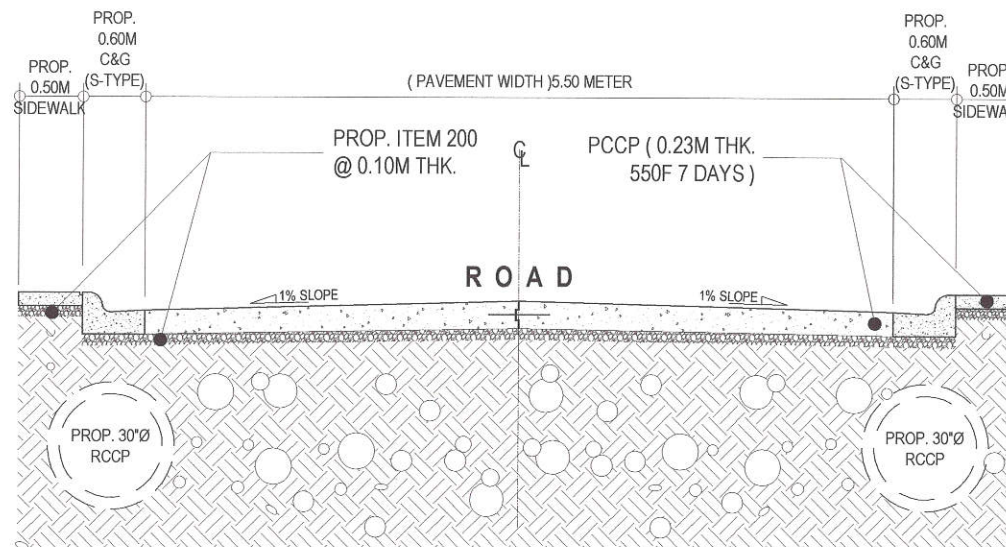
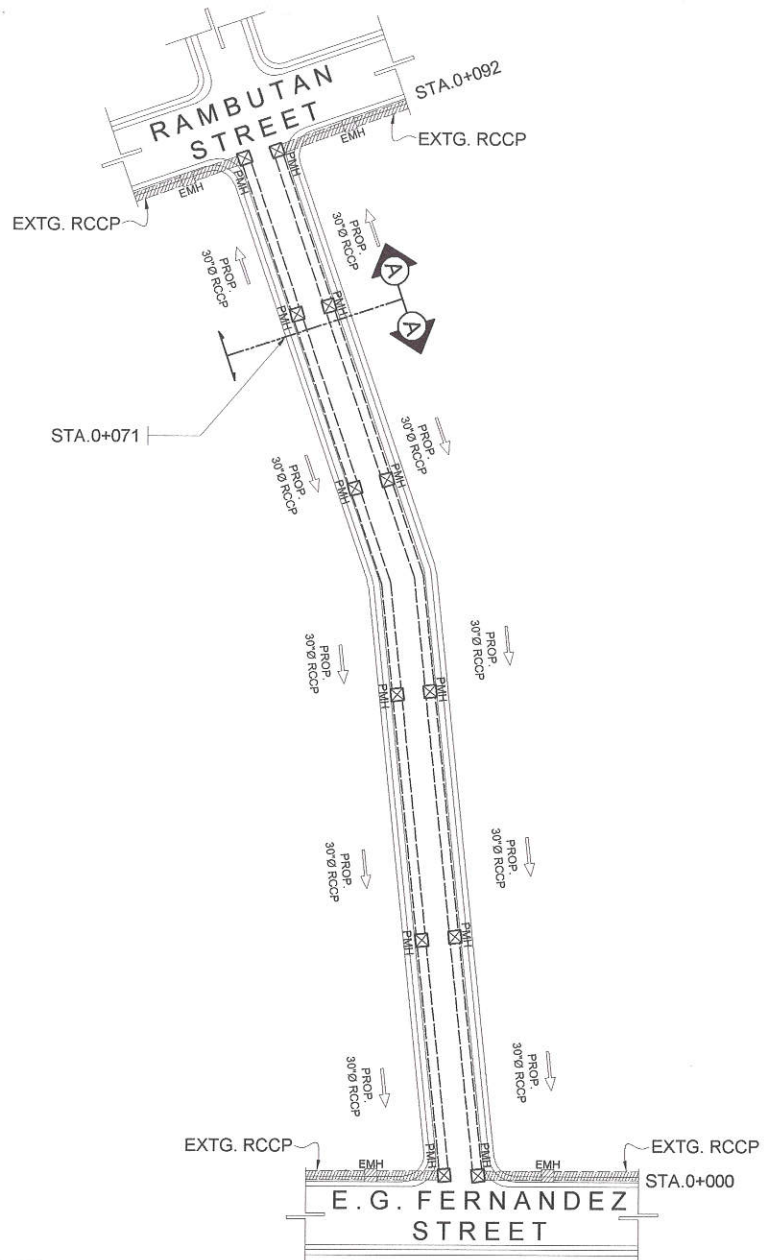

1 PLAN

SCALE : NOT TO SCALE

2 ROADWAY CROSS SECTION OF A-A

SCALE : NOT TO SCALE



Republika ng Pilipinas
Lungsod ng Quezon
CITY ENGINEERING DEPARTMENT

PROJECT TITLE :
**PROPOSED REHABILITATION OF
ROAD AND DRAINAGE AT
DON PEPE STREET**

LOCATION:
BARANGAY STA. MONICA, DISTRICT 5, QUEZON CITY

DRAWN BY: JPCG

DATE: SEPT. 30, 2020

CHECKED BY: *[Signature]*

REVISION NO.:

SUBMITTED BY:

[Signature]
ENGR. LEO S. DEL ROSARIO

HEAD, PLANNING & PROGRAMMING DIVISION

RECOMMENDING APPROVAL:

[Signature]
ENGR. ISAGANI R. VERZOSA, JR.

CITY ENGINEERING DEPARTMENT

APPROVED BY:

[Signature]
HON. MA. JOSEFINA G. BELMONTE

CITY MAYOR, QUEZON CITY

SHEET CONTENT

PLAN
ROADWAY CROSS
SECTION OF A-A

SHEET NO.

**CW
02**

20-00092

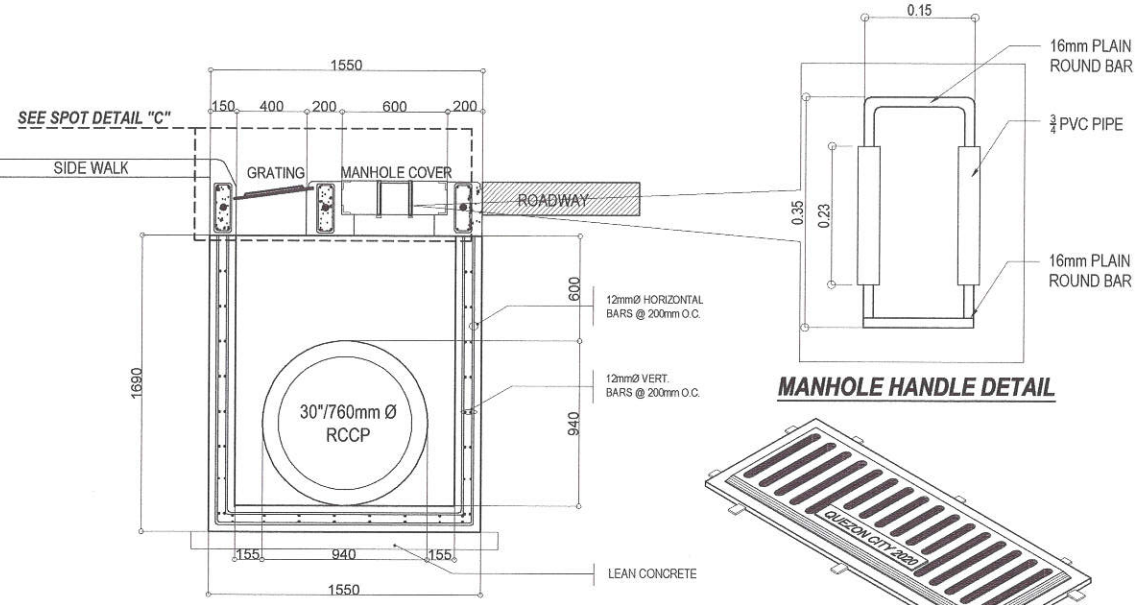

MANHOLE HANDLE DETAIL

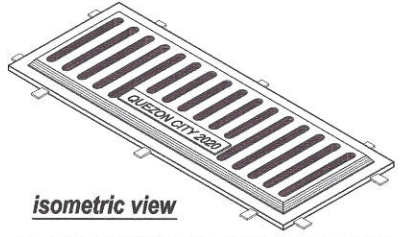

isometric view

ELEVATION SECTION

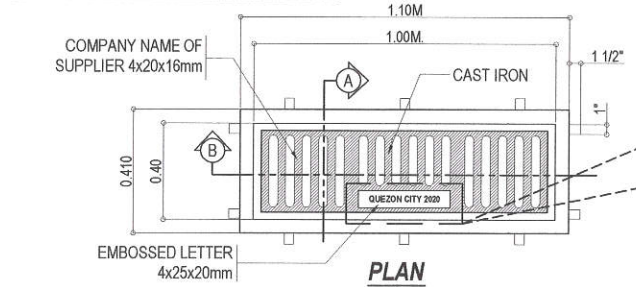

PLAN

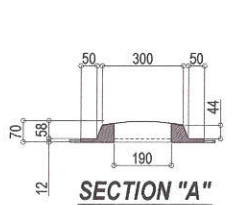

SECTION "A"

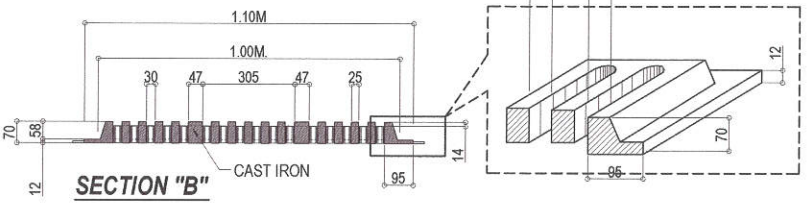

SECTION "B"



PLAN
SCALE: NOT TO SCALE

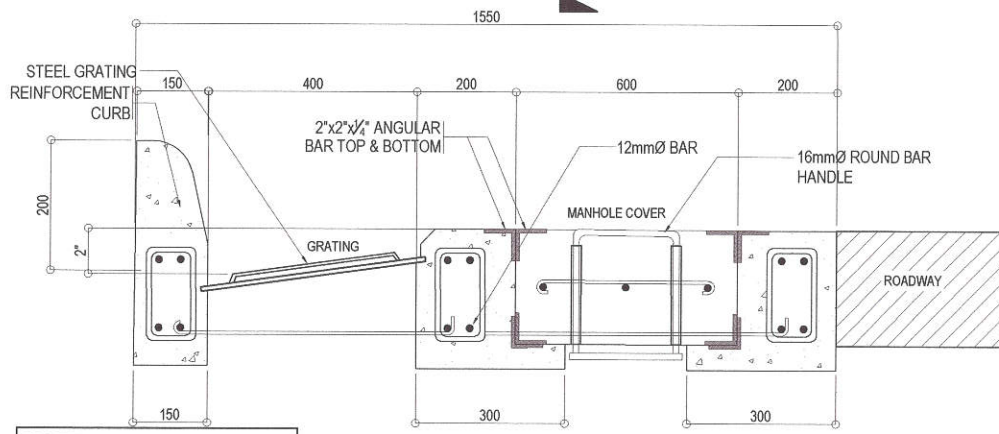

NOTE:
TO AVOID PILFERAGE THE STEEL GRATING SHOULD BE INSTALLED MONOLITHIC WITH CONCRETE POURING OF CONCRETE CURB & LINTEL BEAM

SPOT DETAIL "C"
SCALE: NOT TO SCALE

1 | DETAIL OF MANHOLE AT ROADWAY FOR 30"Ø R.C.C.P.

SCALE : NTS

Republika ng Pilipinas
Lungsod ng Quezon
CITY ENGINEERING DEPARTMENT

PROJECT TITLE:	PROPOSED REHABILITATION OF ROAD AND DRAINAGE AT DON PEPE STREET
LOCATION:	BARANGAY STA. MONICA, DISTRICT 5, QUEZON CITY

DRAWN BY: JPCG	CHECKED BY: <i>[Signature]</i>
DATE: SEPT. 30, 2020	REVISION NO.:

SUBMITTED BY: *[Signature]*
ENGR. LEQS. DEL ROSARIO
HEAD, PLANNING & PROGRAMMING DIVISION

RECOMMENDING APPROVAL: *[Signature]*
ENGR. ISAGANI R. VERZOSA, JR.
CIC CITY ENGINEERING DEPARTMENT

APPROVED BY: *[Signature]*
HON. MA. JOSEFINA G. BELMONTE
CITY MAYOR, QUEZON CITY

SHEET CONTENT: DETAIL MANHOLE AT ROADWAY FOR 30"Ø R.C.C.P.

SHEET NO. **CW 03**

20-00092

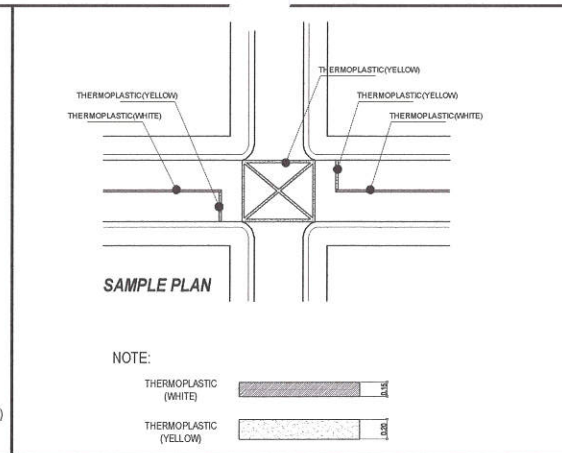
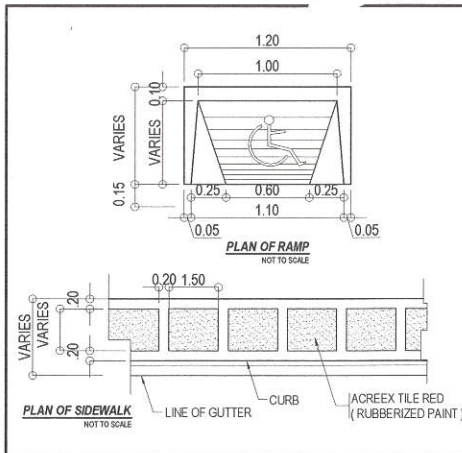

3 PLAN OF RAMP & SIDEWALK

4 THERMOPLASTIC DETAIL SCALE : NTS

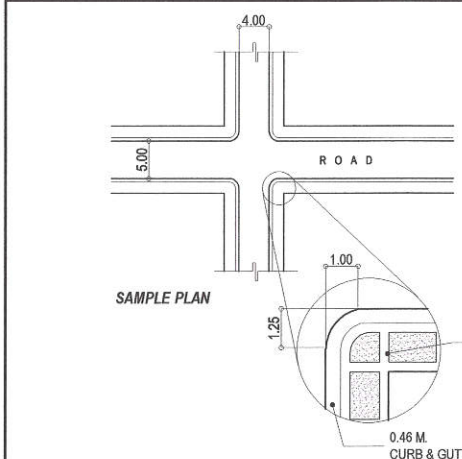

TABLE

PAVEMENT WIDTH (METERS)	CURVATURE LENGTH (METERS)
4.00	1.00
5.00	1.25
6.00	1.50
7.00	1.75
8.00	2.00
9.00	2.25
10.00	2.50
11.00	2.75
12.00	3.00

2 CHAFLAN DETAIL SCALE : NTS

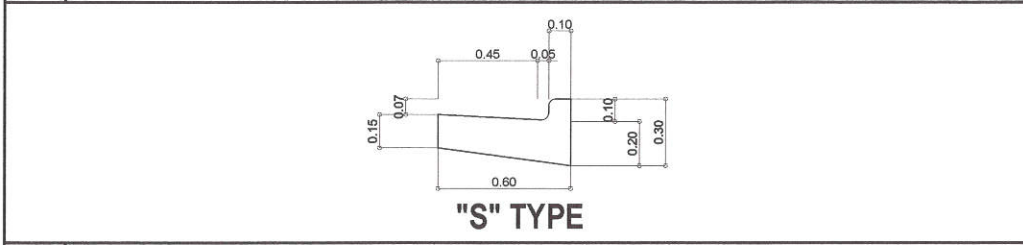

1 TYPICAL CONCRETE CURB DETAIL SCALE : NTS

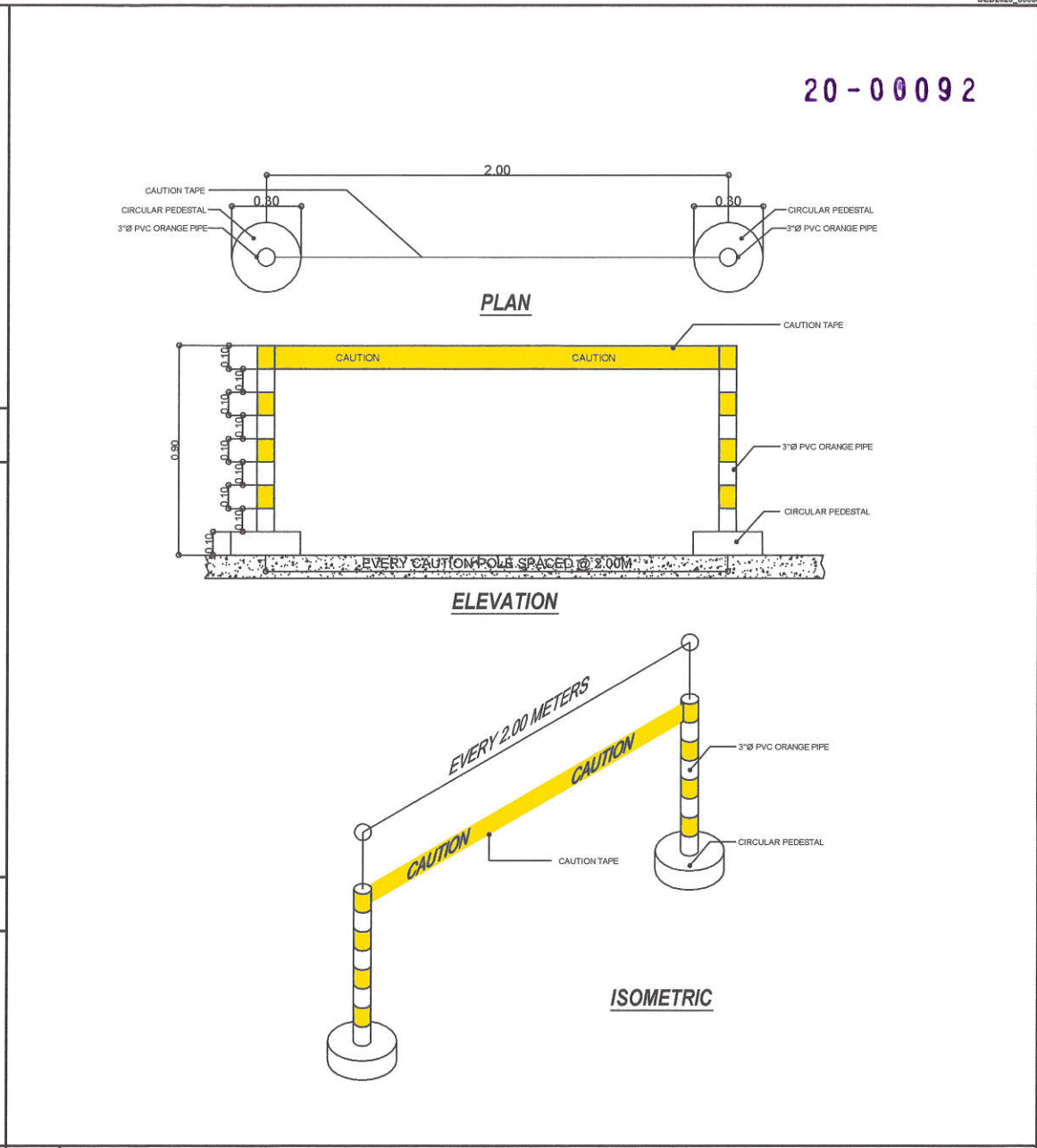

5 SAFETY STRUCTURE SCALE : NTS

Republika ng Pilipinas
Lungsod ng Quezon
CITY ENGINEERING DEPARTMENT

PROJECT TITLE :
PROPOSED REHABILITATION OF ROAD AND DRAINAGE AT DON PEPE STREET

LOCATION :
BARANGAY STA. MONICA ,DISTRICT 5 ,QUEZON CITY

DRAWN BY: JPOG
DATE: SEPT. 30, 2020
CHECKED BY: [Signature]

REVISION NO.:

SUBMITTED BY:
[Signature]
ENGR. LEO S. DEL ROSARIO
HEAD, PLANNING & PROGRAMMING DIVISION

RECOMMENDING APPROVAL:
[Signature]
ENGR. ISABANI R. VERZOSA, JR.
OIC, CITY ENGINEERING DEPARTMENT

APPROVED BY:
[Signature]
HON. MA. JOSEFINA G. BELMORTE
CITY MAYOR, QUEZON CITY

SHEET CONTENT
TYPICAL CONCRETE CURB DETAIL
CHAFLAN DETAIL
PLAN OF RAMP & SIDEWALK
THERMOPLASTIC DETAIL
SAFETY STRUCTURE

SHEET NO.
CW 04

20-00092

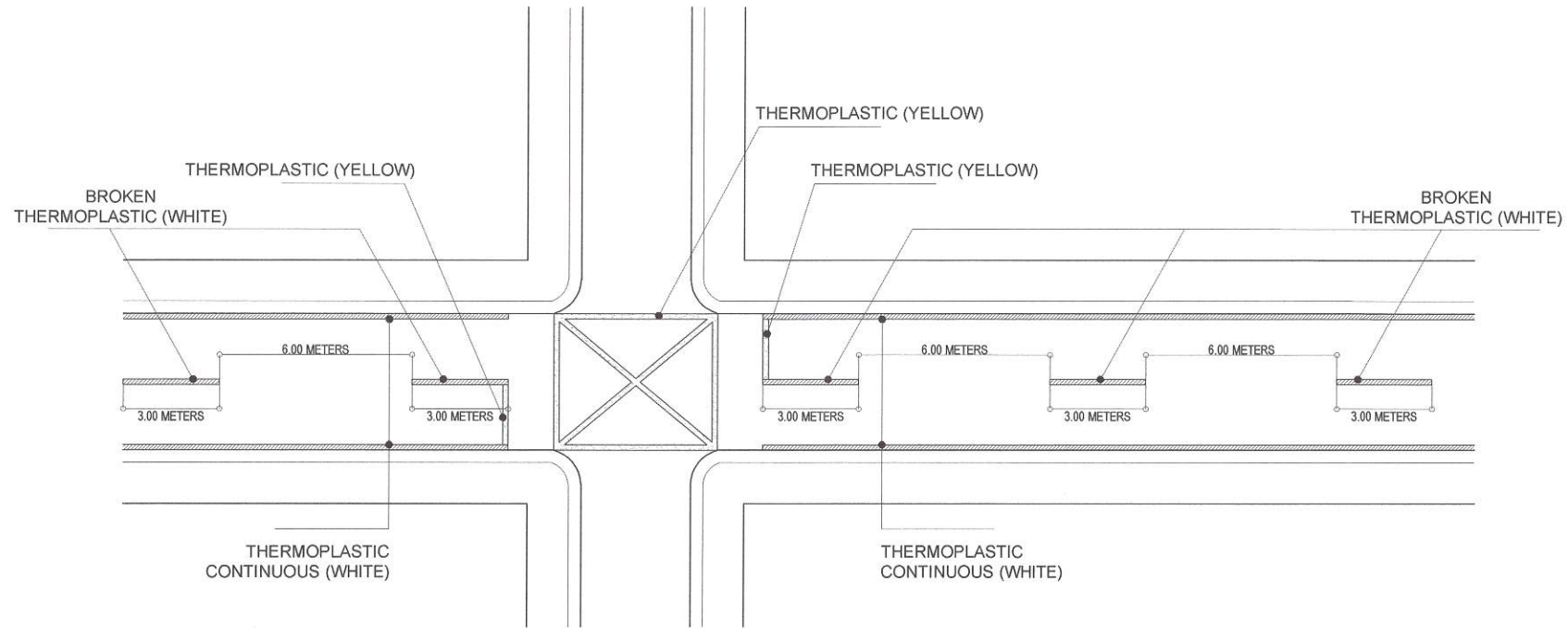



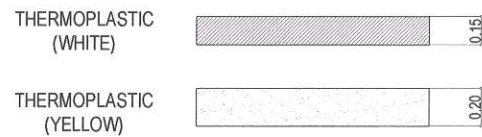

SAMPLE PLAN

NOTE:

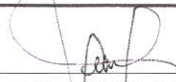

1 THERMO PLASTIC DETAIL

SCALE : NOT TO SCALE

 <p>Republika ng Pilipinas Lungsod ng Quezon CITY ENGINEERING DEPARTMENT</p>	PROJECT TITLE :	DRAWN BY: JPCG	SUBMITTED BY:	RECOMMENDING APPROVAL:	APPROVED BY:	SHEET CONTENT	SHEET NO.
	<p>PROPOSED REHABILITATION OF ROAD AND DRAINAGE AT DON PEPE STREET</p> <p>LOCATION: BARANGAY STA. MONICA, DISTRICT 5, QUEZON CITY</p>	DATE: SEPT. 30, 2020	 ENGR. LEO S. DEL ROSARIO HEAD, PLANNING & PROGRAMMING DIVISION	 ENGR. ISAGANI R. VERZOSA, JR. C.E. CITY ENGINEERING DEPARTMENT	 HON. MA. JOSEFINA G. BELMONTE CITY MAYOR, QUEZON CITY	THERMO PLASTIC DETAIL	
		CHECKED BY: 					

20-00092

ORANGE STREET



RAMBUTAN STREET

SANTOL STREET

SANTOL STREET

THRU SECTION A-A'
 R.O.W.-----2.00 M.
 CARRIAGE WAY-----5.50 M.
 CURB & GUTTER-----0.40 M. (90TH SIDE)
 SIDEWALK-----0.50 M. (90TH SIDE)

THRU SECTION B-B'
 R.O.W.-----8.00 M.
 CARRIAGE WAY-----5.50 M.
 CURB & GUTTER-----0.40 M. (90TH SIDE)
 SIDEWALK-----0.60 M. (90TH SIDE)

E.G. FERNANDEZ ST. (CONC. ROAD)

LEGEND:

R.O.W.-----8.00 M.
 CARRIAGE WAY-----5.00 M.
 CURB & GUTTER-----0.45 M. (90TH SIDE)
 SIDEWALK-----0.80-1.00 M. (90TH SIDE)

CONC. PAVE WITH ASPHALT ON TOP (DILAPIDATED WITH POTHOLES)

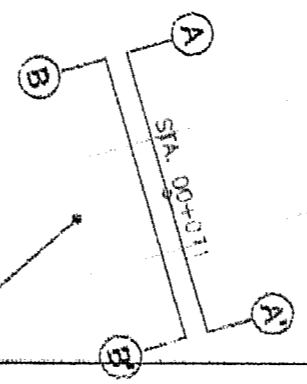
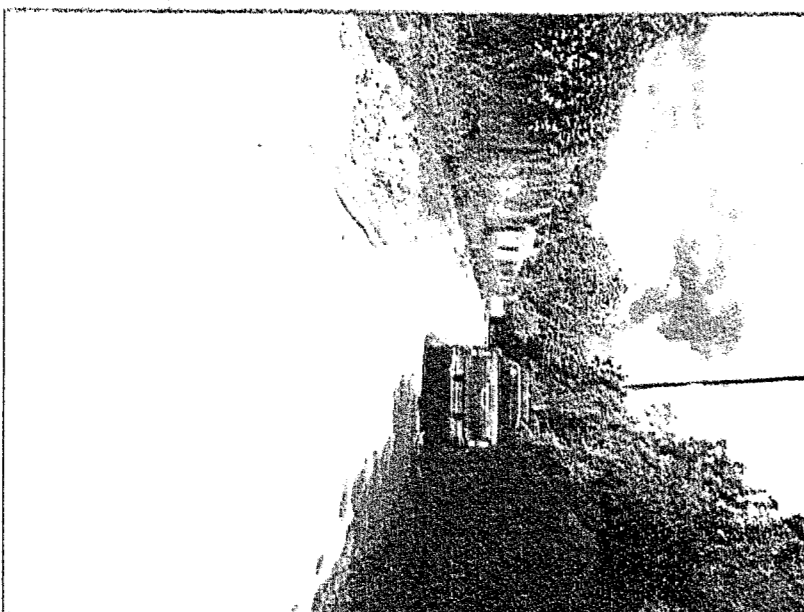
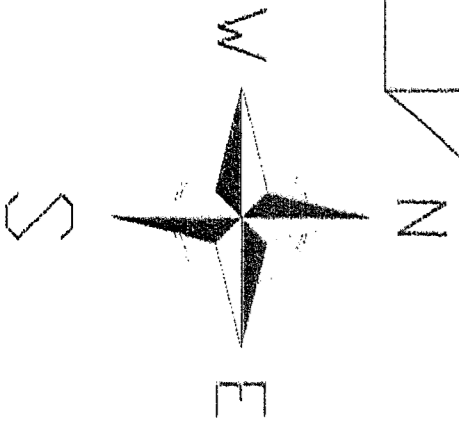

VERIFICATION SURVEY

OF PROPOSED IMPROVEMENT OF ROAD AND DRAINAGE AT DON PEPE STREET
 (SHOWING THE EXISTING CONDITIONED)

LOCATION: PALMERA HOMES, BARANGAY STA. MONICA, QUEZON CITY

PREPARED & SURVEYED BY:

SURVEY SECTION
 PLANNING AND PROGRAMMING DIVISION
 DEPARTMENT OF ENGINEERING, QUEZON CITY

SCALE 1:400 M.

DATE OF SURVEY: DECEMBER 11, 2019

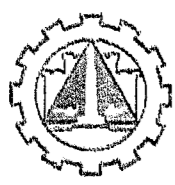

Republika ng Pilipinas
 Lungsod ng Quezon
TANGGAPAN NG INHINYERA
 Office of the City Engineer

Section VIII. Bill of Quantities

Notes on the Bill of Quantities

Objectives

The objectives of the Bill of Quantities are:

- (a) to provide sufficient information on the quantities of Works to be performed to enable Bids to be prepared efficiently and accurately; and
- (b) when a Contract has been entered into, to provide a priced Bill of Quantities for use in the periodic valuation of Works executed.

In order to attain these objectives, Works should be itemized in the Bill of Quantities in sufficient detail to distinguish between the different classes of Works, or between Works of the same nature carried out in different locations or in other circumstances which may give rise to different considerations of cost. Consistent with these requirements, the layout and content of the Bill of Quantities should be as simple and brief as possible.

Daywork Schedule

A Daywork Schedule should be included only if the probability of unforeseen work, outside the items included in the Bill of Quantities, is high. To facilitate checking by the Entity of the realism of rates quoted by the Bidders, the Daywork Schedule should normally comprise the following:

- (a) A list of the various classes of labor, materials, and Constructional Plant for which basic daywork rates or prices are to be inserted by the Bidder, together with a statement of the conditions under which the Contractor will be paid for work executed on a daywork basis.
- (b) Nominal quantities for each item of Daywork, to be priced by each Bidder at Daywork rates as Bid. The rate to be entered by the Bidder against each basic Daywork item should include the Contractor's profit, overheads, supervision, and other charges.

Provisional Sums

A general provision for physical contingencies (quantity overruns) may be made by including a provisional sum in the Summary Bill of Quantities. Similarly, a contingency allowance for possible price increases should be provided as a provisional sum in the Summary Bill of Quantities. The inclusion of such provisional sums often facilitates budgetary approval by avoiding the need to request periodic supplementary approvals as the future need arises. Where such provisional sums or contingency allowances are used, the SCC should state the manner in which they will be used, and under whose authority (usually the Procuring Entity's Representative's).

The estimated cost of specialized work to be carried out, or of special goods to be supplied, by other contractors (refer to **GCC** Clause 8) should be indicated in the relevant part of the

Bill of Quantities as a particular provisional sum with an appropriate brief description. A separate procurement procedure is normally carried out by the Procuring Entity to select such specialized contractors. To provide an element of competition among the Bidders in respect of any facilities, amenities, attendance, etc., to be provided by the successful Bidder as prime Contractor for the use and convenience of the specialist contractors, each related provisional sum should be followed by an item in the Bill of Quantities inviting the Bidder to quote a sum for such amenities, facilities, attendance, etc.

Signature Box

A signature box shall be added at the bottom of each page of the Bill of Quantities where the authorized representative of the Bidder shall affix his signature. Failure of the authorized representative to sign each and every page of the Bill of Quantities shall be a cause for rejection of his bid.

These Notes for Preparing a Bill of Quantities are intended only as information for the Procuring Entity or the person drafting the Bidding Documents. They should not be included in the final documents.

BILL OF QUANTITIES
(Road Construction / Rehabilitation Project)

PROJECT TITLE : PROPOSED REHABILITATION OF ROAD AND DRAINAGE AT DON PEPE STREET

LOCATION : Barangay Sta. Monica, District 5, Quezon City

PROJECT NO. : 20 - 00092

DURATION : Ninety (90) Calendar Days

NAME	TYPE	LENGTH	RROW	WIDTH	Limits
STA. 00+092	Concrete	92 M	7.7 M	5.5 M	Jej To Rambutan Street

Scope of Works:

- 1 General Requirements including Barricade with Caution Tape, Billboard and Construction Safety and Health
- 2 Site Works including Removal of Existing Sidewalk/Driveways, Concrete Pavement, Conc Curb. & Gutter
Demolition of Existing Structure, Roadway Excavation, Excavation for Solid Rock Adobe, Base Course Preparation Leak Repair, Re-layout of existing Water line and Tapping of Drainage
- 3 Civil/Structural Works includes Concreting of pavement, Laying of Concrete Pipes, Construction of Concrete Manholes and painting of Thermoplastic Markings

ITEM NO.	WORK DESCRIPTION AND SCOPE OF WORKS	QTY	UNIT	UNIT COST	AMOUNT
I	GENERAL REQUIREMENTS				
SPL4	Barricade with Caution Tape	72	each	P	P
SPL7	Billboard	2	pc		
SPL12	Construction Safety and Health	1	unit		
				DIRECT COST I	P
II	SITE WORKS				
A.	Demolition Works / Removal of Existing				
104a	Removal of Existing Sidewalk / Driveways	111	sq.m.	P	P
104c	Removal of Existing Concrete Pavement	506	sq.m.		
104d	Removal of Existing Concrete Curb and Gutter	184	l.m.		
B.	Earthworks				
105	Excavation (Roadway)	52	cu.m.		
106c	Excavation (Solid Rock Adobe)	380	cu.m.		
C.	Waterline System				
SPL6	Leak Repair every 20 meters	5	set		
SPL27	Re-layout of existing water line	1	set		
D.	Drainage System				
SPL5	Tapping Drainage	19	set		
				DIRECT COST II	P
III	CIVIL / STRUCTURAL WORKS				
A.	Base Preparation				
200	Aggregate Base Course	71	m.t.	P	P
B.	Laying of Asphalt Pavement				
316c	P.C.C.P., 0.23 m. thk., 550 F, 7 days	499	sq.m.		
B.	Concreting of Sidewalks, Curbs and Gutter				
502c	Concrete Curb & Gutter (S-Type)	184	l.m.		
503	Concrete Sidewalk / Driveways	92	sq.m.		
C.	Laying of Concrete Pipes				
413d	R.C.C.P. 760 mm. diam. (30" diam.)	172	l.m.		
D.	Construction of Concrete Manholes				
SPL1c	Concrete Manhole for 760mm Pipe (Roadway)	12	each		
G.	Painting Works				
SPL10a	Thermoplastic Markings	18	sq.m.		
				DIRECT COST III	P
				TOTAL DIRECT COST	P
				Overhead, Contingencies and Miscellaneous Expenses (OCM)	
				Profit	
				VAT	
				TOTAL ESTIMATED COST	P

PROJECT TITLE : PROPOSED REHABILITATION OF ROAD AND DRAINAGE AT DON PEPE STREET

LOCATION : Barangay Sta. Monica, District 5, Quezon City

PROJECT NO. : 20 - 00092

DURATION : Ninety (90) Calendar Days

BREAKDOWN OF COST

ITEM NO.	WORK DESCRIPTION AND SCOPE OF WORKS	DIRECT COST	INDIRECT COST	AMOUNT
I	GENERAL REQUIREMENTS	P	P	P
II	SITE WORKS			
III	CIVIL / STRUCTURAL WORKS			

TOTAL COST P _____

LUMP SUM BID IN WORDS : _____

Contractor : _____

Section IX. Bidding Forms

TABLE OF CONTENTS

Bid Form.....	77
Form of Contract Agreement	79
Omnibus Sworn Statement.....	81
Bid Securing Declaration.....	84
Affidavit of Undertaking	86
Net Financial Contracting Capacity	87
Single Largest Completed Contract Similar to the Contract to be Bid	88
List of All On-Going Government and Private Contracts.....	89
List of All Awarded But Not Yet Started Government and Private Contracts ..	90
List of Major Equipment to be used for the Project.....	91
List of Key Construction Personnel to be Assigned to the Project.....	92

Bid Form

Date: _____

ITB No: _____

To: *[name and address of PROCURING ENTITY]*

Address: *[insert address]*

We, the undersigned, declare that:

- (a) We have examined and have no reservation to the Bidding Documents, including Addenda, for the Contract *[insert name of contract]*;
- (b) We offer to execute the Works for this Contract in accordance with the Bid and Bid Data Sheet, General and Special Conditions of Contract accompanying this Bid;

The total price of our Bid, excluding any discounts offered below is: *[insert information]*;

The discounts offered and the methodology for their application are: *[insert information]*;

- (c) Our Bid shall be valid for a period of *[insert number]* days from the date fixed for the Bid submission deadline in accordance with the Bidding Documents, and it shall remain binding upon us and may be accepted at any time before the expiration of that period;
- (d) If our Bid is accepted, we commit to obtain a Performance Security in the amount of *[insert percentage amount]* percent of the Contract Price for the due performance of the Contract;
- (e) Our firm, including any subcontractors or suppliers for any part of the Contract, have nationalities from the following eligible countries: *[insert information]*;
- (f) We are not participating, as Bidders, in more than one Bid in this bidding process, other than alternative offers in accordance with the Bidding Documents;
- (g) Our firm, its affiliates or subsidiaries, including any subcontractors or suppliers for any part of the Contract, has not been declared ineligible by the Funding Source;
- (h) We understand that this Bid, together with your written acceptance thereof included in your notification of award, shall constitute a binding contract between us, until a formal Contract is prepared and executed; and
- (i) We understand that you are not bound to accept the Lowest Calculated Bid or any other Bid that you may receive.

- (j) We likewise certify/confirm that the undersigned, is the duly authorized representative of the bidder, and granted full power and authority to do, execute and perform any and all acts necessary to participate, submit the bid, and to sign and execute the ensuing contract for the [Name of Project] of the [Name of the Procuring Entity].
- (k) We acknowledge that failure to sign each and every page of this Bid Form, including the Bill of Quantities, shall be a ground for the rejection of our bid.

Name: _____

In the capacity of: _____

Signed: _____

Duly authorized to sign the Bid for and on behalf of: _____

Date: _____

Form of Contract Agreement

THIS AGREEMENT, made this *[insert date]* day of *[insert month]*, *[insert year]* between *[name and address of PROCURING ENTITY]* (hereinafter called the “Entity”) and *[name and address of Contractor]* (hereinafter called the “Contractor”).

WHEREAS, the Entity is desirous that the Contractor execute *[name and identification number of contract]* (hereinafter called “the Works”) and the Entity has accepted the Bid for *[insert the amount in specified currency in numbers and words]* by the Contractor for the execution and completion of such Works and the remedying of any defects therein.

NOW THIS AGREEMENT WITNESSETH AS FOLLOWS:

1. In this Agreement, words and expressions shall have the same meanings as are respectively assigned to them in the Conditions of Contract hereinafter referred to.
2. The following documents shall be attached, deemed to form, and be read and construed as integral part of this Agreement, to wit:
 - (a) General and Special Conditions of Contract;
 - (b) Drawings/Plans;
 - (c) Specifications;
 - (d) Invitation to Bid;
 - (e) Instructions to Bidders;
 - (f) Bid Data Sheet;
 - (g) Addenda and/or Supplemental/Bid Bulletins, if any;
 - (h) Bid form, including all the documents/statements contained in the Bidder’s bidding envelopes, as annexes, and all other documents submitted (e.g., Bidder’s response to request for clarifications on the bid), including corrections to the bid, if any, resulting from the Procuring Entity’s bid evaluation;
 - (i) Eligibility requirements, documents and/or statements;
 - (j) Performance Security;
 - (k) Notice of Award of Contract and the Bidder’s conforme thereto;
 - (l) Other contract documents that may be required by existing laws and/or the Entity.
3. In consideration of the payments to be made by the Entity to the Contractor as hereinafter mentioned, the Contractor hereby covenants with the Entity to execute and complete the Works and remedy any defects therein in conformity with the provisions of this Contract in all respects.

4. The Entity hereby covenants to pay the Contractor in consideration of the execution and completion of the Works and the remedying of defects wherein, the Contract Price or such other sum as may become payable under the provisions of this Contract at the times and in the manner prescribed by this Contract.

IN WITNESS whereof the parties thereto have caused this Agreement to be executed the day and year first before written.

Signed, sealed, delivered by _____ the _____ (for the Entity)

Signed, sealed, delivered by _____ the _____ (for the Contractor).

Binding Signature of Procuring Entity

Binding Signature of Contractor

[Addendum showing the corrections, if any, made during the Bid evaluation should be attached with this agreement]

Omnibus Sworn Statement

REPUBLIC OF THE PHILIPPINES)
CITY/MUNICIPALITY OF _____) S.S.

AFFIDAVIT

I, *[Name of Affiant]*, of legal age, *[Civil Status]*, *[Nationality]*, and residing at *[Address of Affiant]*, after having been duly sworn in accordance with law, do hereby depose and state that:

1. **Select one, delete the other:**

If a sole proprietorship: I am the sole proprietor or authorized representative of *[Name of Bidder]* with office address at *[address of Bidder]*;

If a partnership, corporation, cooperative, or joint venture: I am the duly authorized and designated representative of *[Name of Bidder]* with office address at *[address of Bidder]*;

2. **Select one, delete the other:**

If a sole proprietorship: As the owner and sole proprietor or authorized representative of *[Name of Bidder]*, I have full power and authority to do, execute and perform any and all acts necessary to participate, submit the bid, and to sign and execute the ensuing contract for *[Name of the Project]* of the *[Name of the Procuring Entity]* *[insert "as shown in the attached duly notarized Special Power of Attorney" for the authorized representative]*;

If a partnership, corporation, cooperative, or joint venture: I am granted full power and authority to do, execute and perform any and all acts necessary to participate, submit the bid, and to sign and execute the ensuing contract for *[Name of the Project]* of the *[Name of the Procuring Entity]*, accompanied by the duly notarized Special Power of Attorney, Board/Partnership Resolution, or Secretary's Certificate, whichever is applicable;

3. *[Name of Bidder]* is not "blacklisted" or barred from bidding by the Government of the Philippines or any of its agencies, offices, corporations, or Local Government Units, foreign government/foreign or international financing institution whose blacklisting rules have been recognized by the Government Procurement Policy Board;

4. Each of the documents submitted in satisfaction of the bidding requirements is an authentic copy of the original, complete, and all statements and information provided therein are true and correct;

5. *[Name of Bidder]* is authorizing the Head of the Procuring Entity or its duly authorized representative(s) to verify all the documents submitted;

6. **Select one, delete the rest:**

If a sole proprietorship: The owner or sole proprietor is not related to the Head of the Procuring Entity, members of the Bids and Awards Committee (BAC), the Technical Working Group, and the BAC Secretariat, the head of the Project Management Office or the end-user unit, and the project consultants by consanguinity or affinity up to the third civil degree;

If a partnership or cooperative: None of the officers and members of *[Name of Bidder]* is related to the Head of the Procuring Entity, members of the Bids and Awards Committee (BAC), the Technical Working Group, and the BAC Secretariat, the head of the Project Management Office or the end-user unit, and the project consultants by consanguinity or affinity up to the third civil degree;

If a corporation or joint venture: None of the officers, directors, and controlling stockholders of *[Name of Bidder]* is related to the Head of the Procuring Entity, members of the Bids and Awards Committee (BAC), the Technical Working Group, and the BAC Secretariat, the head of the Project Management Office or the end-user unit, and the project consultants by consanguinity or affinity up to the third civil degree;

7. *[Name of Bidder]* complies with existing labor laws and standards; and

8. *[Name of Bidder]* is aware of and has undertaken the following responsibilities as a Bidder:

a) Carefully examine all of the Bidding Documents;

b) Acknowledge all conditions, local or otherwise, affecting the implementation of the Contract;

c) Made an estimate of the facilities available and needed for the contract to be bid, if any; and

d) Inquire or secure Supplemental/Bid Bulletin(s) issued for the *[Name of the Project]*.

9. *[Name of Bidder]* did not give or pay directly or indirectly, any commission, amount, fee, or any form of consideration, pecuniary or otherwise, to any person or official, personnel or representative of the government in relation to any procurement project or activity.

IN WITNESS WHEREOF, I have hereunto set my hand this ___ day of ___, 20__ at _____, Philippines.

Bidder's Representative/Authorized Signatory

SUBSCRIBED AND SWORN to before me this ____ day of [month] [year] at [place of execution], Philippines. Affiant/s is/are personally known to me and was/were identified by me through competent evidence of identity as defined in the 2004 Rules on Notarial Practice (A.M. No. 02-8-13-SC). Affiant/s exhibited to me his/her [insert type of government identification card used], with his/her photograph and signature appearing thereon, with no. _____ and his/her Community Tax Certificate No. _____ issued on ____ at _____.

Witness my hand and seal this ____ day of [month] [year].

NAME OF NOTARY PUBLIC

Serial No. of Commission _____

Notary Public for _____ until _____

Roll of Attorneys No. _____

PTR No. _____ [date issued], [place issued]

IBP No. _____ [date issued], [place issued]

Doc. No. _____

Page No. _____

Book No. _____

Series of _____

* This form will not apply for WB funded projects.

Bid-Securing Declaration

(REPUBLIC OF THE PHILIPPINES)

CITY OF _____) S.S.

X-----X

Invitation to Bid *[Insert ITB No.]*

To: *[Insert name and address of the Procuring Entity]*

I/We, the undersigned, declare that:

1. I/We understand that, according to your conditions, bids must be supported by a Bid Security, which may be in the form of a Bid-Securing Declaration.
2. I/We accept that: (a) I/we will be automatically disqualified from bidding for any contract with any procuring entity for a period of two (2) years upon receipt of your Blacklisting Order; and, (b) I/we will pay the applicable fine provided under Section 6 of the Guidelines on the Use of Bid Securing Declaration, within fifteen (15) days from receipt of written demand by the procuring entity for the commission of acts resulting to the enforcement of the bid securing declaration under Sections 23.1(b), 34.2, 40.1 and 69.1, except 69.1 (f), of the IRR of RA 9184; without prejudice to other legal action the government may undertake.
3. I/We understand that this Bid-Securing Declaration shall cease to be valid on the following circumstances:
 - a. Upon expiration of the bid validity period, or any extension thereof pursuant to your request;
 - b. I am/we are declared ineligible or post-disqualified upon receipt of your notice to such effect, and (i) I/we failed to timely file a request for reconsideration or (ii) I/we filed a waiver to avail of said right;
 - c. I am/we are declared as the bidder with the Lowest Calculated Responsive Bid, and I/we have furnished the performance security and signed the Contract.

IN WITNESS WHEREOF, I/We have hereunto set my/our hand/s this ____ day of [month] [year] at [place of execution].

[Insert NAME OF BIDDER'S AUTHORIZED REPRESENTATIVE]
[Insert signatory's legal capacity]

Affiant

SUBSCRIBED AND SWORN to before me this __ day of [month] [year] at [place of execution], Philippines. Affiant/s is/are personally known to me and was/were identified by me through competent evidence of identity as defined in the 2004 Rules on Notarial Practice (A.M. No. 02-8-13-SC). Affiant/s exhibited to me his/her [insert type of government identification card used], with his/her photograph and signature appearing thereon, with no. _____.

Witness my hand and seal this ____ day of [month] [year].

NAME OF NOTARY PUBLIC

Serial No. of Commission _____
Notary Public for _____ **until** _____
Roll of Attorneys No. _____
PTR No. __, [date issued], [place issued]
IBP No. __, [date issued], [place issued]
Doc. No. ____
Page No. ____
Book No. ____
Series of _____.

REPUBLIC OF THE PHILIPPINES)

_____) S. S.

AFFIDAVIT OF UNDERTAKING

I, _____, of legal age, Filipino, _____ **[OFFICER OR REPRESENTATIVE]** _____

with office address at _____ after having been duly sworn to in accordance with law, hereby voluntary depose and state:

That I am duly authorized representative of the **[Name of Bidder]** to execute this undertaking as evidenced by Secretary’s Certificate and Board Resolution.

That **[Name of Bidder]** bidding for the (Name of Project)

That relative to the aforementioned Project, the **[Name of Bidder]** hereby undertake that the equipment to be use and the key personnel to be assign shall exclusively be used and will only perform to the said project until its completion.

That I am executing this affidavit to attest to the truth of the foregoing and in compliance with the submission of the technical requirements for the public bidding of the said project.

IN WITNESS HEREOF, I have hereunto signed my name below this _____ day of _____, _____ at _____.

AFFIANT FURTHER SAYETH NAUGHT.

Affiant

SUBSCRIBED AND SWORN TO BEFORE ME this ___ day of _____, _____ in _____

affiant exhibiting to me his/her _____ issued at _____ on _____.

Doc. No. ;
Page No. ;
Book No. ;
Series of 2020

Notary Public

COMPUTATION OF NET FINANCIAL CONTRACTING CAPACITY (NFCC)

NAME OF BIDDER: _____

CURRENT ASSETS*		PHP	_____
(LESS) CURRENT LIABILITIES*	(LESS)	PHP	_____
NETWORTH		PHP	_____
NETWORTH x 15	x 15	PHP	_____
(LESS) VALUE OF ALL OUTSTANDING ON-GOING CONTRACTS**	(LESS)	PHP	_____
(LESS) VALUE OF ALL AWARDED BUT NOT YET STARTED CONTRACTS AS OF DATE**	(LESS)	PHP	_____
NET FINANCIAL CONTRACTING CAPACITY		PHP	_____

NOTES: * CURRENT ASSETS AND LIABILITIES BASED ON AUDITED FINANCIAL STATEMENT FOR THE PRECEDING CALENDAR YEAR SUBMITTED TO B.I.R.

 ** BASED ON LIST OF ON-GOING AND AWRDED BUT NOT YEY STARTED CONTRACTS SUBMITTED

SINGLE LARGEST COMPLETED CONTRACT SIMILAR TO THE CONTRACT TO BE BID

NAME OF CONTRACTOR: _____

PROJECT TITLE: _____

PROJECT TITLE (Name of the Contract) & EXACT PROJECT LOCATION	DATE OF CONTRACT	CONTRACT DURATION	PROJECT OWNER & POSTAL ADDRESS	NATURE OF WORK	CONTRACTOR'S ROLE (SOLE CONTRACTOR, SUBCONTRACTOR, PARTNER IN A JV) and PERCENTAGE OF PARTICIPATION	TOTAL CONTRACT VALUE AT AWARD	DATE OF COMPLETION or ESTIMATED COMPLETION TIME	TOTAL CONTRACT VALUE AT COMPLETION IF APPLICABLE

PHOTOCOPY ADDITIONAL FORMS, IF NECESSARY

Page _____ of _____

LIST OF ALL ON-GOING GOVERNMENT AND PRIVATE CONTRACTS

NAME OF CONTRACTOR: _____

PROJECT TITLE (Name of the Contract) & EXACT PROJECT LOCATION	DATE OF CONTRACT	CONTRACT DURATION	PROJECT OWNER & POSTAL ADDRESS	NATURE OF WORK	CONTRACTOR'S ROLE (SOLE CONTRACTOR, SUBCONTRACTOR, PARTNER IN A JV) and PERCENTAGE OF PARTICIPATION	TOTAL CONTRACT VALUE AT AWARD	DATE OF COMPLETION or ESTIMATED COMPLETION TIME	TOTAL CONTRACT VALUE AT COMPLETION <i>IF APPLICABLE</i>	PERCENTAGE		VALUE OF OUTSTANDING WORKS (IN PHP)
									ACTUAL ACCOMPLISHMENT	PLANNED ACCOMPLISHMENT	
									TOTAL AMOUNT (Php) OF OUTSTANDING WORKS		

PHOTOCOPY ADDITIONAL FORMS, IF NECESSARY

Page _____ of _____

LIST OF ALL AWARDED BUT NOT YET STARTED GOVERNMENT AND PRIVATE CONTRACTS OF THE BIDDER

NAME OF CONTRACTOR: _____

PROJECT TITLE: _____

PROJECT TITLE & EXACT LOCATION	MAJOR SCOPE OF WORKS & DATE STARTED	NAME AND ADDRESS OF PROJECT OWNER	CONTRACT PRICE (PHP) AS AWARDED	DATE OF SCHEDULED COMPLETION	ROLE OF BIDDER <u>IN THE CONTRACT</u> <u>SOLE CONTRACTOR / SUB-CONTRACTOR/PARTNER IN A</u>
	TOTAL AMOUNT OF CONTRACT (Php)				

LIST OF MAJOR EQUIPMENT TO BE USED FOR THE PROJECT

NAME OF CONTRACTOR: _____

PROJECT TITLE: _____

TYPE	DESCRIPTION / CAPACITY	SERIAL NO.	YEAR ACQUIRED	PRESENT LOCATION (SPECIFIC ADDRESS)	STATUS OF AVAILABILITY (OWNED/LEASED)

PHOTOCOPY ADDITIONAL FORMS, IF NECESSARY

Page _____ of _____

A. LIST OF KEY CONSTRUCTION PERSONNEL TO BE ASSIGNED TO THE PROJECT

NAME OF CONTRACTOR: _____

PROJECT TITLE: _____

NAME	POSITION	AGE	EDUCATIONAL ATTAINMENT	TYPE OF CONSTRUCTION EXPERIENCE	NO.OF YEARS WITH THE CONTRACTOR	PROFESSION	PRC NO.

PHOTOCOPY ADDITIONAL FORMS, IF NECESSARY

Page _____ of _____

