

**PHILIPPINE BIDDING DOCUMENTS**

**Procurement of  
INFRASTRUCTURE  
PROJECTS**

Government of the Republic of the Philippines

**PROPOSED CONSTRUCTION OF ELEVATED WATER  
TANK AT GREEN LAND FARM**

**Project number:  
21-00114**

**Sixth Edition  
July 2020**

# Preface

These Philippine Bidding Documents (PBDs) for the procurement of Infrastructure Projects (hereinafter referred to also as the “Works”) through Competitive Bidding have been prepared by the Government of the Philippines for use by all branches, agencies, departments, bureaus, offices, or instrumentalities of the government, including government-owned and/or -controlled corporations, government financial institutions, state universities and colleges, local government units, and autonomous regional government. The procedures and practices presented in this document have been developed through broad experience, and are for mandatory use in projects that are financed in whole or in part by the Government of the Philippines or any foreign government/foreign or international financing institution in accordance with the provisions of the 2016 revised Implementing Rules and Regulations (IRR) of Republic Act (RA) No. 9184.

The PBDs are intended as a model for admeasurements (unit prices or unit rates in a bill of quantities) types of contract, which are the most common in Works contracting.

The Bidding Documents shall clearly and adequately define, among others: (i) the objectives, scope, and expected outputs and/or results of the proposed contract; (ii) the eligibility requirements of Bidders; (iii) the expected contract duration; and (iv) the obligations, duties, and/or functions of the winning Bidder.

Care should be taken to check the relevance of the provisions of the PBDs against the requirements of the specific Works to be procured. If duplication of a subject is inevitable in other sections of the document prepared by the Procuring Entity, care must be exercised to avoid contradictions between clauses dealing with the same matter.

Moreover, each section is prepared with notes intended only as information for the Procuring Entity or the person drafting the Bidding Documents. They shall not be included in the final documents. The following general directions should be observed when using the documents:

- a. All the documents listed in the Table of Contents are normally required for the procurement of Infrastructure Projects. However, they should be adapted as necessary to the circumstances of the particular Project.
- b. Specific details, such as the “*name of the Procuring Entity*” and “*address for bid submission*,” should be furnished in the Instructions to Bidders, Bid Data Sheet, and Special Conditions of Contract. The final documents should contain neither blank spaces nor options.
- c. This Preface and the footnotes or notes in italics included in the Invitation to Bid, BDS, General Conditions of Contract, Special Conditions of Contract, Specifications, Drawings, and Bill of Quantities are not part of the text of the final document, although they contain instructions that the Procuring Entity should strictly follow.
- d. The cover should be modified as required to identify the Bidding Documents as to the names of the Project, Contract, and Procuring Entity, in addition to date of issue.

- e. Modifications for specific Procurement Project details should be provided in the Special Conditions of Contract as amendments to the Conditions of Contract. For easy completion, whenever reference has to be made to specific clauses in the Bid Data Sheet or Special Conditions of Contract, these terms shall be printed in bold typeface on Sections I (Instructions to Bidders) and III (General Conditions of Contract), respectively.
- f. For guidelines on the use of Bidding Forms and the procurement of Foreign-Assisted Projects, these will be covered by a separate issuance of the Government Procurement Policy Board.

# TABLE OF CONTENTS

<b>Glossary of Terms, Abbreviations, and Acronyms.....</b>	<b>5</b>
<b>Section I. Invitation to Bid .....</b>	<b>8</b>
<b>Section II. Instructions to Bidders.....</b>	<b>9</b>
1. Scope of Bid.....	10
2. Funding Information .....	10
3. Bidding Requirements.....	10
4. Corrupt, Fraudulent, Collusive, Coercive, and Obstructive Practices .....	10
5. Eligible Bidders.....	11
6. Origin of Associated Goods .....	11
7. Subcontracts .....	11
8. Pre-Bid Conference.....	12
9. Clarification and Amendment of Bidding Documents.....	12
10. Documents Comprising the Bid: Eligibility and Technical Components.....	12
11. Documents Comprising the Bid: Financial Component .....	13
12. Alternative Bids .....	13
13. Bid Prices .....	13
14. Bid and Payment Currencies.....	13
15. Bid Security.....	14
16. Sealing and Marking of Bids.....	14
17. Deadline for Submission of Bids .....	14
18. Opening and Preliminary Examination of Bids .....	14
19. Detailed Evaluation and Comparison of Bids.....	14
20. Post Qualification.....	15
21. Signing of the Contract .....	15
<b>Section III. Bid Data Sheet.....</b>	<b>16</b>
<b>Section IV. General Conditions of Contract .....</b>	<b>19</b>
1. Scope of Contract.....	20
2. Sectional Completion of Works.....	20
3. Possession of Site.....	20
4. The Contractor’s Obligations.....	20
5. Performance Security .....	20
6. Site Investigation Reports .....	21

7.	Warranty.....	21
8.	Liability of the Contractor.....	21
9.	Termination for Other Causes.....	21
10.	Dayworks .....	21
11.	Program of Work.....	22
12.	Instructions, Inspections and Audits .....	22
13.	Advance Payment.....	22
14.	Progress Payments .....	22
15.	Operating and Maintenance Manuals.....	22
	<b>Section V. Special Conditions of Contract.....</b>	<b>24</b>
	<b>Section VI. Specifications .....</b>	<b>26</b>
	<b>Section VII. Drawings.....</b>	<b>28</b>
	<b>Section VIII. Bill of Quantities .....</b>	<b>29</b>
	<b>Section IX. Checklist of Technical and Financial Documents.....</b>	<b>31</b>

# *Glossary of Terms, Abbreviations, and Acronyms*

**ABC** – Approved Budget for the Contract.

**ARCC** – Allowable Range of Contract Cost.

**BAC** – Bids and Awards Committee.

**Bid** – A signed offer or proposal to undertake a contract submitted by a bidder in response to and in consonance with the requirements of the bidding documents. Also referred to as *Proposal* and *Tender*. (2016 revised IRR, Section 5[c])

**Bidder** – Refers to a contractor, manufacturer, supplier, distributor and/or consultant who submits a bid in response to the requirements of the Bidding Documents. (2016 revised IRR, Section 5[d])

**Bidding Documents** – The documents issued by the Procuring Entity as the bases for bids, furnishing all information necessary for a prospective bidder to prepare a bid for the Goods, Infrastructure Projects, and/or Consulting Services required by the Procuring Entity. (2016 revised IRR, Section 5[e])

**BIR** – Bureau of Internal Revenue.

**BSP** – Bangko Sentral ng Pilipinas.

**CDA** – Cooperative Development Authority.

**Consulting Services** – Refer to services for Infrastructure Projects and other types of projects or activities of the GOP requiring adequate external technical and professional expertise that are beyond the capability and/or capacity of the GOP to undertake such as, but not limited to: (i) advisory and review services; (ii) pre-investment or feasibility studies; (iii) design; (iv) construction supervision; (v) management and related services; and (vi) other technical services or special studies. (2016 revised IRR, Section 5[i])

**Contract** – Refers to the agreement entered into between the Procuring Entity and the Supplier or Manufacturer or Distributor or Service Provider for procurement of Goods and Services; Contractor for Procurement of Infrastructure Projects; or Consultant or Consulting Firm for Procurement of Consulting Services; as the case may be, as recorded in the Contract Form signed by the parties, including all attachments and appendices thereto and all documents incorporated by reference therein.

**Contractor** – is a natural or juridical entity whose proposal was accepted by the Procuring Entity and to whom the Contract to execute the Work was awarded. Contractor as used in these Bidding Documents may likewise refer to a supplier, distributor, manufacturer, or consultant.

**CPI** – Consumer Price Index.

**DOLE** – Department of Labor and Employment.

**DTI** – Department of Trade and Industry.

**Foreign-funded Procurement or Foreign-Assisted Project** – Refers to procurement whose funding source is from a foreign government, foreign or international financing institution as specified in the Treaty or International or Executive Agreement. (2016 revised IRR, Section 5[b]).

**GFI** – Government Financial Institution.

**GOCC** – Government-owned and/or –controlled corporation.

**Goods** – Refer to all items, supplies, materials and general support services, except Consulting Services and Infrastructure Projects, which may be needed in the transaction of public businesses or in the pursuit of any government undertaking, project or activity, whether in the nature of equipment, furniture, stationery, materials for construction, or personal property of any kind, including non-personal or contractual services such as the repair and maintenance of equipment and furniture, as well as trucking, hauling, janitorial, security, and related or analogous services, as well as procurement of materials and supplies provided by the Procuring Entity for such services. The term “related” or “analogous services” shall include, but is not limited to, lease or purchase of office space, media advertisements, health maintenance services, and other services essential to the operation of the Procuring Entity. (2016 revised IRR, Section 5[r])

**GOP** – Government of the Philippines.

**Infrastructure Projects** – Include the construction, improvement, rehabilitation, demolition, repair, restoration or maintenance of roads and bridges, railways, airports, seaports, communication facilities, civil works components of information technology projects, irrigation, flood control and drainage, water supply, sanitation, sewerage and solid waste management systems, shore protection, energy/power and electrification facilities, national buildings, school buildings, hospital buildings, and other related construction projects of the government. Also referred to as *civil works or works*. (2016 revised IRR, Section 5[u])

**LGUs** – Local Government Units.

**NFCC** – Net Financial Contracting Capacity.

**NGA** – National Government Agency.

**PCAB** – Philippine Contractors Accreditation Board.

**PhilGEPS** - Philippine Government Electronic Procurement System.

**Procurement Project** – refers to a specific or identified procurement covering goods, infrastructure project or consulting services. A Procurement Project shall be described, detailed, and scheduled in the Project Procurement Management Plan prepared by the agency which shall be consolidated in the procuring entity's Annual Procurement Plan. (GPPB Circular No. 06-2019 dated 17 July 2019)

**PSA** – Philippine Statistics Authority.

**SEC** – Securities and Exchange Commission.

**SLCC** – Single Largest Completed Contract.

**UN** – United Nations.



## ***Section I. Invitation to Bid***

### **Notes on the Invitation to Bid**

The Invitation to Bid (IB) provides information that enables potential Bidders to decide whether to participate in the procurement at hand. The IB shall be posted in accordance with Section 21.2 of the 2016 revised IRR of RA No. 9184.

Apart from the essential items listed in the Bidding Documents, the IB should also indicate the following:

- a. The date of availability of the Bidding Documents, which shall be from the time the IB is first advertised/posted until the deadline for the submission and receipt of bids;
- b. The place where the Bidding Documents may be acquired or the website where it may be downloaded;
- c. The deadline for the submission and receipt of bids; and
- d. Any important bid evaluation criteria.

The IB should be incorporated into the Bidding Documents. The information contained in the IB must conform to the Bidding Documents and in particular to the relevant information in the Bid Data Sheet.



**REPUBLIC OF THE PHILIPPINES**  
**QUEZON CITY GOVERNMENT**  
**BIDS AND AWARDS COMMITTEE FOR INFRASTRUCTURE &**  
**CONSULTANCY**



2<sup>nd</sup> floor, Finance Building, Procurement Department, Quezon City Hall Complex, Elliptical Road, Quezon City

August 5, 2021

## Invitation to Bid

No.	Project No.	Project Name	Location	Amount	Durati on Cal. Days	Office	Source Fund
<b><i>Buildings – Small B</i></b>							
1	21-00113	Proposed Rehabilitation of Day Care Center at Moises Street, Jordan Plains Subdivision	Sta. Monica	1,199,533.23	45	City Engineering Department	Engineering Department
2	21-00114	Proposed Construction of Elevated Water Tank at Green Land Farm	Bagong Silangan	1,575,587.55	45	City Engineering Department	Engineering Department
3	21-00115	Proposed Rehabilitation of Herminigildo I. Flores Hall / Building	Pansol	2,239,733.99	90	City Engineering Department	Engineering Department - SB # 1
4	21-00116	Proposed Construction of Stage at San Antonio Elementary School	Katipunan	3,665,744.44	90	City Engineering Department	Engineering Department
5	21-00117	Proposed Rehabilitation of Del Nacia Ville 4 Multi Purpose Building and Basketball Court	Sauyo	5,624,258.29	90	City Engineering Department	Engineering Department - SB # 1
6	21-00118	Proposed Rehabilitation of Barangay Hall	White Plains	6,481,788.27	120	City Engineering Department	Engineering Department - SB # 1
7	21-00119	Proposed Rehabilitation of Barangay Hall Main Building	Holy Spirit	11,049,980.27	120	City Engineering Department	Engineering Department - SB # 1
8	21-00120	Proposed Rehabilitation of Novaliches District Center	Novaliches Proper	13,669,012.48	330	City Engineering Department	Engineering Department
<b><i>Roads - Small B</i></b>							
9	21-00121	Proposed Rehabilitation (Surface Improvement) of St. John Street	New Era	1,059,004.15	20	City Engineering Department	20% Community Development Fund
10	21-00122	Proposed Rehabilitation of Road and Drainage at Malusog Street	UP Village	1,826,922.80	120	City Engineering Department	20% Community Development Fund
11	21-00123	Proposed Rehabilitation (Surface Improvement) at Banaba Street and Dungon Street	Amihan	2,023,097.66	25	City Engineering Department	20% Community Development Fund
12	21-00124	Proposed Rehabilitation of Drainage System at Holy Spirit Drive (Puregold to Don Faustino)	Holy Spirit	2,568,673.41	90	City Engineering Department	Engineering Department

13	21-00125	Proposed Rehabilitation (Surface Improvement) at Yakal Street	Amihan	2,837,148.43	25	City Engineering Department	20% Community Development Fund
14	21-00126	Proposed Rehabilitation of (Surface Improvement) at Claims Street and Dalsol Street	Sangandaan	2,894,635.72	25	City Engineering Department	20% Community Development Fund
15	21-00127	Proposed Rehabilitation (Surface Improvement) at K-9th Street	East Kamias	4,330,133.17	40	City Engineering Department	20% Community Development Fund
16	21-00128	Proposed Rehabilitation (Surface Improvement) at Aguho Street	Claro	5,121,426.21	45	City Engineering Department	20% Community Development Fund
17	21-00129	Proposed Rehabilitation (Surface Improvement) at K-8th Street	East Kamias	5,268,191.75	45	City Engineering Department	20% Community Development Fund
18	21-00130	Proposed Rehabilitation of Road and Drainage at Jamaica Street	St. Ignatius	5,414,043.21	90	City Engineering Department	20% Community Development Fund
19	21-00131	Proposed Rehabilitation of Road and Drainage at Woodside Street	St. Ignatius	6,078,162.90	90	City Engineering Department	20% Community Development Fund
20	21-00132	Proposed Surface Improvement and Rehabilitation of Road and Drainage at Greenville Drive and Leo Street	Sauyo	7,770,399.54	150	City Engineering Department	20% Community Development Fund
21	21-00133	Proposed Rehabilitation (Surface Improvement) of Banawe Street (Quezon Ave. to E. Rodriguez Sr. Ave.)	Tatalon/ Doña Josefa	7,925,646.74	35	City Engineering Department	20% Community Development Fund
22	21-00134	Proposed Rehabilitation (Surface Improvement) at Xavierville Avenue	Loyola Heights	10,661,551.06	70	City Engineering Department	20% Community Development Fund
23	21-00135	Proposed Rehabilitation of Road and Drainage at Ofelia Street	Bahay Toro	17,188,296.30	180	City Engineering Department	20% Community Development Fund
<b>Roads – Medium A</b>							
24	21-00136	Proposed Rehabilitation of Road and Drainage at Old Samson Road	Balingasa	32,258,140.48	360	City Engineering Department	20% Community Development Fund

1. The **QUEZON CITY LOCAL GOVERNMENT**, through *funding source of various years* intends to apply the sum stated above being the Approved Budget for the Contract (ABC) to payments under the contract *for the above stated Projects*. Bids received in excess of the ABC shall be automatically rejected at bid opening.

2. The **QUEZON CITY LOCAL GOVERNMENT** now invites bids for the above Procurement Project. Completion of the Works is required *as stated above*. Bidders should have completed a contract similar to the Project. The description of an eligible bidder is contained in the Bidding Documents, particularly, in Section II (Instructions to Bidders).
3. Bidding will be conducted through open competitive bidding procedures using non-discretionary “*pass/fail*” criterion as specified in the 2016 revised Implementing Rules and Regulations (IRR) of Republic Act (RA) No. 9184.
4. Interested bidders may obtain further information from **QUEZON CITY LOCAL GOVERNMENT – BAC Secretariat** and inspect the Bidding Documents at the address given below *weekdays from 8:00 am. – 5:00 p.m.*
5. A complete set of Bidding Documents may be acquired by interested bidders on **6 August 2021 (Friday)** from given address and website/s below *and upon payment of a non-refundable fee for the Bidding Documents, pursuant to the latest Guidelines issued by the GPPB*. The Procuring Entity shall allow the bidder to present its proof of payment for the fees *presented in person*.

**STANDARD RATES:**

<b>Approved Budget for the Contract</b>	<b>Maximum Cost of Bidding Documents (in Philippine Peso)</b>
More than 1 Million up to 5 Million	5,000.00
More than 5 Million up to 10 Million	10,000.00
More than 10 Million up to 50 Million	25,000.00
More than 50 Million up to 500 Million	50,000.00
More than 500 Million	75,000.00

The following are the requirements for purchase of Bidding Documents;

1. PhilGEPS Registration Certificate (Platinum – 3 Pages)
2. Document Request List (DRL)
3. Authorization to purchase bidding documents
  - 3.1 Secretary’s Certificate (for corporation)
  - 3.2 Special Power of Attorney (for sole proprietorship)
4. Notarized Joint Venture Agreement (if applicable)
5. Letter of Intent

It must be duly received by the BAC Secretariat at 2<sup>nd</sup> Floor, Procurement Department, Finance Building, Quezon City Hall Compound on or before **August 13, 2021 - 5:00PM**.

6. The **QC- BAC- INFRASTRUCTURE & CONSULTANCY** will hold a Pre-Bid Conference<sup>1</sup> on **August 17, 2021 at 10:00 AM** at **2<sup>nd</sup> Floor, Procurement Department-Bidding Room, Finance Building, Quezon City Hall Compound** or we encourage the prospective bidders to join through our **Virtual Conference (ZOOM APP)** which shall be open to prospective bidders.

**Virtual Conference (ZOOM APP)**  
**Meeting ID: 854 9489 0133**  
**Password: 273320**

7. Bids must be duly received by the BAC Secretariat through manual submission at the office address as indicated below, on or before **August 31, 2021 – 9:00AM**. Late bids shall not be accepted.

<sup>1</sup> May be deleted in case the ABC is less than One Million Pesos (PhP1,000,000) where the Procuring Entity may not hold a pre-bid conference.

8. All bids must be accompanied by a bid security in any of the acceptable forms and in the amount stated in **ITB** Clause 16.
9. Bid opening shall be on **August 31, 2021 - 10:00 AM** at **2<sup>nd</sup> Floor, Procurement Department-Bidding Room, Finance Building, Quezon City Hall Compound** and/or via Zoom. Bids will be opened in the presence of the bidders' representatives who choose to attend the activity.

**Virtual Conference (ZOOM APP)**

**Meeting ID: 810 3646 5257**

**Password: 201522**

10. The **Quezon City Local Government** reserves the right to reject any and all bids, declare a failure of bidding, or not award the contract at any time prior to contract award in accordance with Sections 35.6 and 41 of the 2016 revised Implementing Rules and Regulations (IRR) of RA No. 9184, without thereby incurring any liability to the affected bidder or bidders.
11. For further information, please refer to:

**ATTY. DOMINIC B. GARCIA**  
OIC, Procurement Department  
2<sup>nd</sup> Floor, Procurement Department,  
Finance Building, Quezon City Hall Compound  
Elliptical Road, Barangay Central Diliman, Quezon City.  
Tel. No. (02)8988-4242 loc. 8506/8710  
Email Add: bacinfra.procurement@quezoncity.gov.ph  
Website: [www.quezoncity.gov.ph](http://www.quezoncity.gov.ph)

12. You may visit the following websites:

For downloading of Bidding Documents: <https://quezoncity.gov.ph/public-notices/procurement/>

By:

  
**ATTY. MARK DALE DIAMOND P. PERRAL**  
Chairman, BAC-Infra and Consultancy

## ***Section II. Instructions to Bidders***

### **Notes on the Instructions to Bidders**

This Section on the Instruction to Bidders (ITB) provides the information necessary for bidders to prepare responsive bids, in accordance with the requirements of the Procuring Entity. It also provides information on bid submission, eligibility check, opening and evaluation of bids, post-qualification, and on the award of contract.

## 1. **Scope of Bid**

The Procuring Entity, **Quezon City Government** invites Bids for the **PROPOSED CONSTRUCTION OF ELEVATED WATER TANK AT GREEN LAND FARM**, with Project Identification Number **21-00114**.

*[Note: The Project Identification Number is assigned by the Procuring Entity based on its own coding scheme and is not the same as the PhilGEPS reference number, which is generated after the posting of the bid opportunity on the PhilGEPS website.]*

The Procurement Project (referred to herein as “Project”) is for the construction of Works, as described in Section VI (Specifications).

## 2. **Funding Information**

2.1. The GOP through the source of funding as indicated below for **2021** in the amount of **One Million Five Hundred Seventy-Five Thousand Five Hundred Eighty-Seven Pesos & 55/100 Cts. (P 1,575,587.55)**.

2.2. The source of funding is:

a. LGUs, the Annual or Supplemental Budget, as approved by the Sanggunian.

## 3. **Bidding Requirements**

The Bidding for the Project shall be governed by all the provisions of RA No. 9184 and its 2016 revised IRR, including its Generic Procurement Manual and associated policies, rules and regulations as the primary source thereof, while the herein clauses shall serve as the secondary source thereof.

Any amendments made to the IRR and other GPPB issuances shall be applicable only to the ongoing posting, advertisement, or invitation to bid by the BAC through the issuance of a supplemental or bid bulletin.

The Bidder, by the act of submitting its Bid, shall be deemed to have inspected the site, determined the general characteristics of the contracted Works and the conditions for this Project, such as the location and the nature of the work; (b) climatic conditions; (c) transportation facilities; (c) nature and condition of the terrain, geological conditions at the site communication facilities, requirements, location and availability of construction aggregates and other materials, labor, water, electric power and access roads; and (d) other factors that may affect the cost, duration and execution or implementation of the contract, project, or work and examine all instructions, forms, terms, and project requirements in the Bidding Documents.

## 4. **Corrupt, Fraudulent, Collusive, Coercive, and Obstructive Practices**

The Procuring Entity, as well as the Bidders and Contractors, shall observe the highest standard of ethics during the procurement and execution of the contract. They or through an agent shall not engage in corrupt, fraudulent, collusive, coercive, and

obstructive practices defined under Annex “P” of the 2016 revised IRR of RA No. 9184 or other integrity violations in competing for the Project.

## 5. Eligible Bidders

- 5.1. Only Bids of Bidders found to be legally, technically, and financially capable will be evaluated.
- 5.2. The Bidder must have an experience of having completed a Single Largest Completed Contract (SLCC) that is similar to this Project, equivalent to at least fifty percent (50%) of the ABC adjusted, if necessary, by the Bidder to current prices using the PSA’s CPI, except under conditions provided for in Section 23.4.2.4 of the 2016 revised IRR of RA No. 9184.  
  
A contract is considered to be “similar” to the contract to be bid if it has the major categories of work stated in the **BDS**.
- 5.3. For Foreign-funded Procurement, the Procuring Entity and the foreign government/foreign or international financing institution may agree on another track record requirement, as specified in the Bidding Document prepared for this purpose.
- 5.4. The Bidders shall comply with the eligibility criteria under Section 23.4.2 of the 2016 IRR of RA No. 9184.

## 6. Origin of Associated Goods

There is no restriction on the origin of Goods other than those prohibited by a decision of the UN Security Council taken under Chapter VII of the Charter of the UN.

## 7. Subcontracts

- 7.1. The Bidder may subcontract portions of the Project to the extent allowed by the Procuring Entity as stated herein, but in no case more than fifty percent (50%) of the Project.

The Procuring Entity has prescribed that:

- a. **Subcontracting is not allowed.**

- 7.1. *[If Procuring Entity has determined that subcontracting is allowed during the bidding , state:]* The Bidder must submit together with its Bid the documentary requirements of the subcontractor(s) complying with the eligibility criterial stated in **ITB** Clause 5 in accordance with Section 23.4 of the 2016 revised IRR of RA No. 9184 pursuant to Section 23.1 thereof.
- 7.2. *[If subcontracting is allowed during the contract implementation stage, state:]* The Supplier may identify its subcontractor during the contract implementation stage. Subcontractors identified during the bidding may be changed during the implementation of this Contract. Subcontractors must submit the documentary



requirements under Section 23.1 of the 2016 revised IRR of RA No. 9184 and comply with the eligibility criteria specified in **ITB** Clause 5 to the implementing or end-user unit.

- 7.3. Subcontracting of any portion of the Project does not relieve the Contractor of any liability or obligation under the Contract. The Supplier will be responsible for the acts, defaults, and negligence of any subcontractor, its agents, servants, or workmen as fully as if these were the Contractor's own acts, defaults, or negligence, or those of its agents, servants, or workmen.

## **8. Pre-Bid Conference**

The Procuring Entity will hold a pre-bid conference for this Project on the specified date and time and either at its physical address on **August 17, 2021, 10:00 A.M. at 2nd Floor, Procurement Department-Bidding Room, Finance Building, Quezon City Hall Compound** and/or we encourage the prospective bidders to join through our **Virtual Conference (ZOOM APP) Meeting ID: 854 9489 0133 Password: 273320**

## **9. Clarification and Amendment of Bidding Documents**

Prospective bidders may request for clarification on and/or interpretation of any part of the Bidding Documents. Such requests must be in writing and received by the Procuring Entity, either at its given address or through electronic mail indicated in the **IB**, at least ten (10) calendar days before the deadline set for the submission and receipt of Bids.

## **10. Documents Comprising the Bid: Eligibility and Technical Components**

- 10.1. The first envelope shall contain the eligibility and technical documents of the Bid as specified in **Section IX. Checklist of Technical and Financial Documents**.
- 10.2. If the eligibility requirements or statements, the bids, and all other documents for submission to the BAC are in foreign language other than English, it must be accompanied by a translation in English, which shall be authenticated by the appropriate Philippine foreign service establishment, post, or the equivalent office having jurisdiction over the foreign bidder's affairs in the Philippines. For Contracting Parties to the Apostille Convention, only the translated documents shall be authenticated through an apostille pursuant to GPPB Resolution No. 13-2019 dated 23 May 2019. The English translation shall govern, for purposes of interpretation of the bid.
- 10.3. A valid PCAB License is required, and in case of joint ventures, a valid special PCAB License, and registration for the type and cost of the contract for this Project. Any additional type of Contractor license or permit shall be indicated in the **BDS**.
- 10.4. A List of Contractor's key personnel (e.g., Project Manager, Project Engineers, Materials Engineers, and Foremen) assigned to the contract to be bid, with their

complete qualification and experience data shall be provided. These key personnel must meet the required minimum years of experience set in the **BDS**.

- 10.5. A List of Contractor's major equipment units, which are owned, leased, and/or under purchase agreements, supported by proof of ownership, certification of availability of equipment from the equipment lessor/vendor for the duration of the project, as the case may be, must meet the minimum requirements for the contract set in the **BDS**.

## **11. Documents Comprising the Bid: Financial Component**

- 11.1. The second bid envelope shall contain the financial documents for the Bid as specified in **Section IX. Checklist of Technical and Financial Documents**.
- 11.2. Any bid exceeding the ABC indicated in paragraph 1 of the **IB** shall not be accepted.
- 11.3. For Foreign-funded procurement, a ceiling may be applied to bid prices provided the conditions are met under Section 31.2 of the 2016 revised IRR of RA No. 9184.

## **12. Alternative Bids**

Bidders shall submit offers that comply with the requirements of the Bidding Documents, including the basic technical design as indicated in the drawings and specifications. Unless there is a value engineering clause in the **BDS**, alternative Bids shall not be accepted.

## **13. Bid Prices**

All bid prices for the given scope of work in the Project as awarded shall be considered as fixed prices, and therefore not subject to price escalation during contract implementation, except under extraordinary circumstances as determined by the NEDA and approved by the GPPB pursuant to the revised Guidelines for Contract Price Escalation guidelines.

## **14. Bid and Payment Currencies**

- 14.1. Bid prices may be quoted in the local currency or tradeable currency accepted by the BSP at the discretion of the Bidder. However, for purposes of bid evaluation, Bids denominated in foreign currencies shall be converted to Philippine currency based on the exchange rate as published in the BSP reference rate bulletin on the day of the bid opening.
- 14.2. *Payment of the contract price shall be made in:*
  - a. Philippine Pesos.

## **15. Bid Security**

- 15.1. The Bidder shall submit a Bid Securing Declaration or any form of Bid Security in the amount indicated in the **BDS**, which shall be not less than the percentage of the ABC in accordance with the schedule in the **BDS**.
- 15.2. The Bid and bid security **in no case shall exceed One Hundred Twenty (120) calendar days from the date of opening of bids, unless duly extended by the bidder upon the request of the Head of the Procuring Entity (HoPE) of the Quezon City Local Government**. Any bid not accompanied by an acceptable bid security shall be rejected by the Procuring Entity as non-responsive.

## **16. Sealing and Marking of Bids**

Each Bidder shall submit one copy of the first and second components of its Bid.

The Procuring Entity may request additional hard copies and/or electronic copies of the Bid. However, failure of the Bidders to comply with the said request shall not be a ground for disqualification.

If the Procuring Entity allows the submission of bids through online submission to the given website or any other electronic means, the Bidder shall submit an electronic copy of its Bid, which must be digitally signed. An electronic copy that cannot be opened or is corrupted shall be considered non-responsive and, thus, automatically disqualified.

## **17. Deadline for Submission of Bids**

The Bidders shall submit on the specified date and time and either at its physical address or through online submission as indicated in paragraph 5 of the **IB**.

## **18. Opening and Preliminary Examination of Bids**

- 18.1. The BAC shall open the Bids in public at the time, on the date, and at the place specified in paragraph 9 of the **IB**. The Bidders' representatives who are present shall sign a register evidencing their attendance. In case videoconferencing, webcasting or other similar technologies will be used, attendance of participants shall likewise be recorded by the BAC Secretariat.

In case the Bids cannot be opened as scheduled due to justifiable reasons, the rescheduling requirements under Section 29 of the 2016 revised IRR of RA No. 9184 shall prevail.

- 18.2. The preliminary examination of Bids shall be governed by Section 30 of the 2016 revised IRR of RA No. 9184.

## **19. Detailed Evaluation and Comparison of Bids**

- 19.1. The Procuring Entity's BAC shall immediately conduct a detailed evaluation of all Bids rated "*passed*" using non-discretionary pass/fail criteria. The BAC

shall consider the conditions in the evaluation of Bids under Section 32.2 of 2016 revised IRR of RA No. 9184.

- 19.2. If the Project allows partial bids, all Bids and combinations of Bids as indicated in the **BDS** shall be received by the same deadline and opened and evaluated simultaneously so as to determine the Bid or combination of Bids offering the lowest calculated cost to the Procuring Entity. Bid Security as required by **ITB** Clause 15 shall be submitted for each contract (lot) separately.
- 19.3. In all cases, the NFCC computation pursuant to Section 23.4.2.6 of the 2016 revised IRR of RA No. 9184 must be sufficient for the total of the ABCs for all the lots participated in by the prospective Bidder.

## **20. Post Qualification**

Within a non-extendible period of five (5) calendar days from receipt by the Bidder of the notice from the BAC that it submitted the Lowest Calculated Bid, the Bidder shall submit its latest income and business tax returns filed and paid through the BIR Electronic Filing and Payment System (eFPS), and other appropriate licenses and permits required by law and stated in the **BDS**.

## **21. Signing of the Contract**

The documents required in Section 37.2 of the 2016 revised IRR of RA No. 9184 shall form part of the Contract. Additional Contract documents are indicated in the **BDS**.

## ***Section III. Bid Data Sheet***

### **Notes on the Bid Data Sheet (BDS)**

The Bid Data Sheet (BDS) consists of provisions that supplement, amend, or specify in detail, information, or requirements included in the ITB found in Section II, which are specific to each procurement.

This Section is intended to assist the Procuring Entity in providing the specific information in relation to corresponding clauses in the ITB and has to be prepared for each specific procurement.

The Procuring Entity should specify in the BDS information and requirements specific to the circumstances of the Procuring Entity, the processing of the procurement, and the bid evaluation criteria that will apply to the Bids. In preparing the BDS, the following aspects should be checked:

- a. Information that specifies and complements provisions of the ITB must be incorporated.
- b. Amendments and/or supplements, if any, to provisions of the ITB as necessitated by the circumstances of the specific procurement, must also be incorporated.

# Bid Data Sheet

ITB Clause																																	
5.2	For this purpose, similar contracts shall refer to contracts which have the same major categories of work.																																
7.1	<b>Subcontracting is not allowed.</b>																																
10.3	<p><i>No additional contractor license or permit is required</i></p> <p><b><i>In addition, eligible bidders shall qualify or comply with the following:</i></b></p> <p>1. Bidders with valid Philippine Contractors Accreditation Board (PCAB)</p> <p style="padding-left: 40px;">Type</p> <p style="text-align: center;"><b>Buildings - Small B</b></p>																																
10.4	<p>The minimum work experience requirements for key personnel are the following:</p> <table border="1" style="width: 100%; border-collapse: collapse; margin-left: 20px;"> <thead> <tr> <th style="text-align: center;">Qty.</th> <th style="text-align: center;">Key Personnel</th> <th style="text-align: center;">General Experience</th> <th style="text-align: center;">Relevant Experience</th> </tr> </thead> <tbody> <tr> <td style="text-align: center;">1</td> <td>Project Engineer</td> <td style="text-align: center;">3 years</td> <td style="text-align: center;">3 years</td> </tr> <tr> <td style="text-align: center;">1</td> <td>DPWH duly accredited Materials Engineer</td> <td style="text-align: center;">3 years</td> <td style="text-align: center;">3 years</td> </tr> <tr> <td style="text-align: center;">1</td> <td>Safety Officer</td> <td style="text-align: center;">3 years</td> <td style="text-align: center;">3 years</td> </tr> <tr> <td style="text-align: center;">1</td> <td>Foreman</td> <td style="text-align: center;">3 years</td> <td style="text-align: center;">3 years</td> </tr> <tr> <td style="text-align: center;">8</td> <td>Skilled Worker</td> <td style="text-align: center;">3 years</td> <td style="text-align: center;">3 years</td> </tr> <tr> <td style="text-align: center;">1</td> <td>Driver</td> <td style="text-align: center;">3 years</td> <td style="text-align: center;">3 years</td> </tr> <tr> <td style="text-align: center;">12</td> <td>Laborer/Helper</td> <td style="text-align: center;">1 year</td> <td style="text-align: center;">3 months</td> </tr> </tbody> </table> <p><b><i>In addition, the bidder must execute an affidavit of undertaking duly notarized stating that the foregoing personnel shall perform work exclusively for the project until its completion. Please see attached bid forms.</i></b></p>	Qty.	Key Personnel	General Experience	Relevant Experience	1	Project Engineer	3 years	3 years	1	DPWH duly accredited Materials Engineer	3 years	3 years	1	Safety Officer	3 years	3 years	1	Foreman	3 years	3 years	8	Skilled Worker	3 years	3 years	1	Driver	3 years	3 years	12	Laborer/Helper	1 year	3 months
Qty.	Key Personnel	General Experience	Relevant Experience																														
1	Project Engineer	3 years	3 years																														
1	DPWH duly accredited Materials Engineer	3 years	3 years																														
1	Safety Officer	3 years	3 years																														
1	Foreman	3 years	3 years																														
8	Skilled Worker	3 years	3 years																														
1	Driver	3 years	3 years																														
12	Laborer/Helper	1 year	3 months																														
10.5	<p>The minimum major equipment requirements are the following:</p> <table border="1" style="width: 100%; border-collapse: collapse; margin-left: 20px;"> <thead> <tr> <th style="text-align: center;">Equipment</th> <th style="text-align: center;">Capacity</th> <th style="text-align: center;">Number of Units</th> </tr> </thead> <tbody> <tr> <td>Elf Truck</td> <td></td> <td style="text-align: center;">1</td> </tr> <tr> <td>Scaffolding</td> <td></td> <td style="text-align: center;">As needed</td> </tr> <tr> <td>Power Tools</td> <td></td> <td style="text-align: center;">As needed</td> </tr> <tr> <td>Minor Tools</td> <td></td> <td style="text-align: center;">As needed</td> </tr> </tbody> </table> <p><b><i>In addition, the bidder must execute an affidavit of undertaking duly</i></b></p>	Equipment	Capacity	Number of Units	Elf Truck		1	Scaffolding		As needed	Power Tools		As needed	Minor Tools		As needed																	
Equipment	Capacity	Number of Units																															
Elf Truck		1																															
Scaffolding		As needed																															
Power Tools		As needed																															
Minor Tools		As needed																															

	<i>notarized stating that the foregoing equipment shall be used exclusively for the project until its completion. Please see attached bid forms.</i>
12	<i>[Insert Value Engineering clause if allowed.]</i>
15.1	The bid security shall be in the form of a Bid Securing Declaration with project number, or any of the following forms and amounts: <ul style="list-style-type: none"> <li>a) The amount of not less than Php 31,511.75 or equivalent to two percent (2%) of ABC if bid security is in cash, cashier's/manager's check, bank draft/guarantee or irrevocable letter of credit; or</li> <li>b) The amount of not less than Php 78,779.38 or equivalent to five percent (5%) of ABC if bid security is in Surety Bond.</li> </ul>
19.2	<b>Partial bid is not allowed.</b> The infrastructure project is packaged in a single lot and the lot shall not be divided into sub-lots for the purpose of bidding, evaluation, and contract award.
20	No additional requirement.
21	<b>Additional Contract Documents relevant to the Project as required:</b> <ol style="list-style-type: none"> <li><b>1. Construction Schedule and S-curve,</b></li> <li><b>2. Manpower Schedule,</b></li> <li><b>3. Construction Methods,</b></li> <li><b>4. Equipment Utilization Schedule,</b></li> <li><b>5. PERT/CPM or other acceptable tools of project scheduling, shall be included in the submission of Technical Proposal.</b></li> </ol>

## ***Section IV. General Conditions of Contract***

### **Notes on the General Conditions of Contract**

The General Conditions of Contract (GCC) in this Section, read in conjunction with the Special Conditions of Contract in Section V and other documents listed therein, should be a complete document expressing all the rights and obligations of the parties.

Matters governing performance of the Contractor, payments under the contract, or matters affecting the risks, rights, and obligations of the parties under the contract are included in the GCC and Special Conditions of Contract.

Any complementary information, which may be needed, shall be introduced only through the Special Conditions of Contract.



## 1. **Scope of Contract**

This Contract shall include all such items, although not specifically mentioned, that can be reasonably inferred as being required for its completion as if such items were expressly mentioned herein. All the provisions of RA No. 9184 and its 2016 revised IRR, including the Generic Procurement Manual, and associated issuances, constitute the primary source for the terms and conditions of the Contract, and thus, applicable in contract implementation. Herein clauses shall serve as the secondary source for the terms and conditions of the Contract.

This is without prejudice to Sections 74.1 and 74.2 of the 2016 revised IRR of RA No. 9184 allowing the GPPB to amend the IRR, which shall be applied to all procurement activities, the advertisement, posting, or invitation of which were issued after the effectivity of the said amendment.

## 2. **Sectional Completion of Works**

If sectional completion is specified in the **Special Conditions of Contract (SCC)**, references in the Conditions of Contract to the Works, the Completion Date, and the Intended Completion Date shall apply to any Section of the Works (other than references to the Completion Date and Intended Completion Date for the whole of the Works).

## 3. **Possession of Site**

3.1 The Procuring Entity shall give possession of all or parts of the Site to the Contractor based on the schedule of delivery indicated in the **SCC**, which corresponds to the execution of the Works. If the Contractor suffers delay or incurs cost from failure on the part of the Procuring Entity to give possession in accordance with the terms of this clause, the Procuring Entity's Representative shall give the Contractor a Contract Time Extension and certify such sum as fair to cover the cost incurred, which sum shall be paid by Procuring Entity.

3.2 If possession of a portion is not given by the above date, the Procuring Entity will be deemed to have delayed the start of the relevant activities. The resulting adjustments in contract time to address such delay may be addressed through contract extension provided under Annex "E" of the 2016 revised IRR of RA No. 9184.

## 4. **The Contractor's Obligations**

The Contractor shall employ the key personnel named in the Schedule of Key Personnel indicating their designation, in accordance with **ITB** Clause 10.3 and specified in the **BDS**, to carry out the supervision of the Works.

The Procuring Entity will approve any proposed replacement of key personnel only if their relevant qualifications and abilities are equal to or better than those of the personnel listed in the Schedule.

## 5. **Performance Security**

- 5.1. Within ten (10) calendar days from receipt of the Notice of Award from the Procuring Entity but in no case later than the signing of the contract by both parties, the successful Bidder shall furnish the performance security in any of the forms prescribed in Section 39 of the 2016 revised IRR.
- 5.2. The Contractor, by entering into the Contract with the Procuring Entity, acknowledges the right of the Procuring Entity to institute action pursuant to RA No. 3688 against any subcontractor be they an individual, firm, partnership, corporation, or association supplying the Contractor with labor, materials and/or equipment for the performance of this Contract.

## **6. Site Investigation Reports**

The Contractor, in preparing the Bid, shall rely on any Site Investigation Reports referred to in the SCC supplemented by any information obtained by the Contractor.

## **7. Warranty**

- 7.1. In case the Contractor fails to undertake the repair works under Section 62.2.2 of the 2016 revised IRR, the Procuring Entity shall forfeit its performance security, subject its property(ies) to attachment or garnishment proceedings, and perpetually disqualify it from participating in any public bidding. All payables of the GOP in his favor shall be offset to recover the costs.
- 7.2. The warranty against Structural Defects/Failures, except that occasioned-on force majeure, shall cover the period from the date of issuance of the Certificate of Final Acceptance by the Procuring Entity. Specific duration of the warranty is found in the SCC.

## **8. Liability of the Contractor**

Subject to additional provisions, if any, set forth in the SCC, the Contractor's liability under this Contract shall be as provided by the laws of the Republic of the Philippines.

If the Contractor is a joint venture, all partners to the joint venture shall be jointly and severally liable to the Procuring Entity.

## **9. Termination for Other Causes**

Contract termination shall be initiated in case it is determined *prima facie* by the Procuring Entity that the Contractor has engaged, before, or during the implementation of the contract, in unlawful deeds and behaviors relative to contract acquisition and implementation, such as, but not limited to corrupt, fraudulent, collusive, coercive, and obstructive practices as stated in ITB Clause 4.

## **10. Dayworks**

Subject to the guidelines on Variation Order in Annex “E” of the 2016 revised IRR of RA No. 9184, and if applicable as indicated in the **SCC**, the Dayworks rates in the Contractor’s Bid shall be used for small additional amounts of work only when the Procuring Entity’s Representative has given written instructions in advance for additional work to be paid for in that way.

## **11. Program of Work**

11.1. The Contractor shall submit to the Procuring Entity’s Representative for approval the said Program of Work showing the general methods, arrangements, order, and timing for all the activities in the Works. The submissions of the Program of Work are indicated in the **SCC**.

11.2. The Contractor shall submit to the Procuring Entity’s Representative for approval an updated Program of Work at intervals no longer than the period stated in the **SCC**. If the Contractor does not submit an updated Program of Work within this period, the Procuring Entity’s Representative may withhold the amount stated in the **SCC** from the next payment certificate and continue to withhold this amount until the next payment after the date on which the overdue Program of Work has been submitted.

## **12. Instructions, Inspections and Audits**

The Contractor shall permit the GOP or the Procuring Entity to inspect the Contractor’s accounts and records relating to the performance of the Contractor and to have them audited by auditors of the GOP or the Procuring Entity, as may be required.

## **13. Advance Payment**

The Procuring Entity shall, upon a written request of the Contractor which shall be submitted as a Contract document, make an advance payment to the Contractor in an amount not exceeding fifteen percent (15%) of the total contract price, to be made in lump sum, or at the most two installments according to a schedule specified in the **SCC**, subject to the requirements in Annex “E” of the 2016 revised IRR of RA No. 9184.

## **14. Progress Payments**

The Contractor may submit a request for payment for Work accomplished. Such requests for payment shall be verified and certified by the Procuring Entity’s Representative/Project Engineer. Except as otherwise stipulated in the **SCC**, materials and equipment delivered on the site but not completely put in place shall not be included for payment.

## **15. Operating and Maintenance Manuals**

15.1. If required, the Contractor will provide “as built” Drawings and/or operating and maintenance manuals as specified in the **SCC**.

- 15.2. If the Contractor does not provide the Drawings and/or manuals by the dates stated above, or they do not receive the Procuring Entity's Representative's approval, the Procuring Entity's Representative may withhold the amount stated in the **SCC** from payments due to the Contractor.

## ***Section V. Special Conditions of Contract***

### **Notes on the Special Conditions of Contract**

Similar to the BDS, the clauses in this Section are intended to assist the Procuring Entity in providing contract-specific information in relation to corresponding clauses in the GCC found in Section IV.

The Special Conditions of Contract (SCC) complement the GCC, specifying contractual requirements linked to the special circumstances of the Procuring Entity, the Procuring Entity's country, the sector, and the Works procured. In preparing this Section, the following aspects should be checked:

- a. Information that complements provisions of the GCC must be incorporated.
- b. Amendments and/or supplements to provisions of the GCC as necessitated by the circumstances of the specific purchase, must also be incorporated.

However, no special condition which defeats or negates the general intent and purpose of the provisions of the GCC should be incorporated herein.

# Special Conditions of Contract

GCC Clause	
2	Completion of work shall be within 45 calendar days.
4.1	The Procuring Entity shall give possession of all parts of the Site to the Contractor upon receipt of the Notice to Proceed.
6	The site investigation reports are: <i>[list here the required site investigation reports.]</i>
7.2	<p><i>[Select one, delete the other.]</i></p> <p><i>[In case of permanent structures, such as buildings of types 4 and 5 as classified under the National Building Code of the Philippines and other structures made of steel, iron, or concrete which comply with relevant structural codes (e.g., DPWH Standard Specifications), such as, but not limited to, steel/concrete bridges, flyovers, aircraft movement areas, ports, dams, tunnels, filtration and treatment plants, sewerage systems, power plants, transmission and communication towers, railway system, and other similar permanent structures:]</i> Fifteen (15) years.</p> <p><i>[In case of semi-permanent structures, such as buildings of types 1, 2, and 3 as classified under the National Building Code of the Philippines, concrete/asphalt roads, concrete river control, drainage, irrigation lined canals, river landing, deep wells, rock causeway, pedestrian overpass, and other similar semi-permanent structures:]</i> Five (5) years.</p> <p><i>[In case of other structures, such as bailey and wooden bridges, shallow wells, spring developments, and other similar structures:]</i> Two (2) years.</p>
10	Dayworks are applicable at the rate shown in the Contractor’s original Bid.
13	The amount of the advance payment is no more that fifteen percent (15%) of the Contract Price subject to approval by the HOPE and compliance with the conditions under RA 9184 and its IRR.
14	No further instructions.
15.1	<p>The date by which operating and maintenance manuals are required is <i>thirty (30) days</i></p> <p>The date by which “as built” drawings are required as part of final payment</p>
15.2	The amount to be withheld for failing to produce “as built” drawings and/or operating and maintenance manuals by the date required is ten (10%) percent of the contract price.

## *Section VI. Specifications*

### **Notes on Specifications**

A set of precise and clear specifications is a prerequisite for Bidders to respond realistically and competitively to the requirements of the Procuring Entity without qualifying or conditioning their Bids. In the context of international competitive bidding, the specifications must be drafted to permit the widest possible competition and, at the same time, present a clear statement of the required standards of workmanship, materials, and performance of the goods and services to be procured. Only if this is done will the objectives of economy, efficiency, and fairness in procurement be realized, responsiveness of Bids be ensured, and the subsequent task of bid evaluation facilitated. The specifications should require that all goods and materials to be incorporated in the Works be new, unused, of the most recent or current models, and incorporate all recent improvements in design and materials unless provided otherwise in the Contract.

Samples of specifications from previous similar projects are useful in this respect. The use of metric units is mandatory. Most specifications are normally written specially by the Procuring Entity or its representative to suit the Works at hand. There is no standard set of Specifications for universal application in all sectors in all regions, but there are established principles and practices, which are reflected in these PBDs.

There are considerable advantages in standardizing General Specifications for repetitive Works in recognized public sectors, such as highways, ports, railways, urban housing, irrigation, and water supply, in the same country or region where similar conditions prevail. The General Specifications should cover all classes of workmanship, materials, and equipment commonly involved in construction, although not necessarily to be used in a particular Works Contract. Deletions or addenda should then adapt the General Specifications to the particular Works.

Care must be taken in drafting specifications to ensure that they are not restrictive. In the specification of standards for goods, materials, and workmanship, recognized international standards should be used as much as possible. Where other particular standards are used, whether national standards or other standards, the specifications should state that goods, materials, and workmanship that meet other authoritative standards, and which ensure substantially equal or higher quality than the standards mentioned, will also be acceptable. The following clause may be inserted in the SCC.

#### **Sample Clause: Equivalency of Standards and Codes**

Wherever reference is made in the Contract to specific standards and codes to be met by the goods and materials to be furnished, and work performed or tested, the provisions of the latest current edition or revision of the relevant standards and codes in effect shall apply, unless otherwise expressly stated in the Contract. Where such standards and codes are national, or relate to a particular country or region, other authoritative standards that ensure a substantially equal or higher quality than the standards and codes specified will be accepted

subject to the Procuring Entity's Representative's prior review and written consent. Differences between the standards specified and the proposed alternative standards shall be fully described in writing by the Contractor and submitted to the Procuring Entity's Representative at least twenty-eight (28) days prior to the date when the Contractor desires the Procuring Entity's Representative's consent. In the event the Procuring Entity's Representative determines that such proposed deviations do not ensure substantially equal or higher quality, the Contractor shall comply with the standards specified in the documents.

These notes are intended only as information for the Procuring Entity or the person drafting the Bidding Documents. They should not be included in the final Bidding Documents.





*Republic of the Philippines*  
*Quezon City*

## **CITY ENGINEERING DEPARTMENT**

Civic Center Building B, Quezon City Hall Compound, Elliptical Road  
Diliman, Central 1100 Quezon City  
Trunk line: +63 2 8988 4242



# **TECHNICAL SPECIFICATIONS**

## **QUEZON CITY INFRASTRUCTURE PROJECT**

**PROJECT TITLE : PROPOSED CONSTRUCTION OF ELEVATED WATER TANK  
AT GREEN LAND FARM**

**LOCATION: BARANGAY BAGONG SILANGAN, DISTRICT 2, QUEZON CITY**

### **I. GENERAL REQUIREMENTS**

- a. Comply with the current and existing laws, ordinances and applicable codes, rules and regulations and standards. Any works perform contrary to the existing laws, rules and regulations, ordinances and standards without notice shall bear all cost arising therefrom.
- b. Drawings, specifications, codes and standards are minimum requirements. Where requirements differ, the more stringent apply.
- c. Should there be any change(s) in drawings or specifications, it is required to comply with the governing regulations, notify the implementing agency.
- d. Photographs shall be taken as, when and where directed at intervals of not more than one month. The photographs shall be sufficient in number and location to record the exact progress of the works. The photographs shall be retained and will become the property of the Government.
- e. Site verification / inspection shall be conducted to validate the scope of works. No extra compensation and extension of time shall be given due to negligence or inadvertence.
- f. The quality of materials shall be of the best grade of their respective kinds for the purpose. The work shall also be performed in the best and most capable manner in strict accordance with requirements of the plans and details. All materials not conforming to the requirements of these specifications shall be considered as defective.
- g. All equipment and installations shall meet or exceed minimum requirements of the standards and codes.
- h. Mobilization and Demobilization (if applicable)
  - i. Mobilization shall include all activities and related costs for transportation of personnel, equipment, and operating supplies to the site; establishment of offices, buildings, and other necessary general facilities for the operations at the site.
  - ii. Demobilization shall include all activities and costs for transportation of personnel, equipment, and supplies not anymore required within the construction site including the disassembly, removal and site clean-up of offices and other facilities assembled on the site specifically for this contract.
- i. Execute work in strict accordance with the best practices of the trades in a thorough, substantial, workmanlike manner by competent workmen. Provide a competent, experienced, full-time supervisor who is authorized to make decisions on behalf of the Contractor.
- j. Temporary Facilities and Utilities
  - i. All facilities shall be near the job site, where necessary and shall conform to the best standard for the required types.

- ii. Temporary facilities shall be provided and maintained including sanitary facilities and first aid stations.
  - iii. Temporary utilities shall be sufficiently provided until the completion of the project such as water, power and communication.
  - iv. Temporary enclosure shall be provided within the construction site with adequate guard lights, railings and proper signages.
  - v. Temporary roadways shall be constructed and maintained to sustain loads to be carried on them during the entire construction period.
  - vi. Upon completion of the work, the temporary facilities shall be demolished, hauled-out and disposed properly.
- k. Adequate construction safety and health protection shall be provided at all times during the execution of work to both workers and property.
- i. A fully trained Medical Aide shall be employed permanently on the site who shall be engaged solely from medical duties.
  - ii. The medical room shall be provided in waterproof; it could be a building or room designated and used exclusively for the purpose and have a floor area of at least 15 square meters and a glazed window area of at least 2 square meters.
  - iii. The location of the medical room and any other arrangements shall be made known to all employees by posting on prominent locations suitable notices in the site.
  - iv. Additional safety precautions shall be provided in the observance of pandemic. Protocols set-forth by the government shall be strictly followed.
- l. Necessary protections to the adjacent property shall be provided to avoid untoward incidents / accidents.
- m. Final cleaning of the work shall be employed prior to the final inspection for certification of final acceptance. Final cleaning shall be applied on each surface or unit of work and shall be of condition expected for a building cleaning and maintenance program.

## II. SITE WORKS

- A. All grades, lines, levels and dimensions shall be verified as indicated on the plans and details. Any discrepancies or inconsistencies shall be reported before commencing to work.
- B. Removal / demolition of existing structures shall be done in accordance to safety procedures.
- C. All excavations shall be made to grade as indicated in the plans. Whenever water is encountered in the excavation process, it shall be removed by pumping, care being taken that the surrounding soil particles are not disturbed or removed.
- D. All backfills shall be placed in layers not exceeding to 150mm in thickness and each layer shall be thoroughly compacted wetting, tamping and rolling.

## III. CIVIL / STRUCTURAL WORKS

### A. CONCRETE WORK

- a. Delivery, Storage, and Handling: All materials shall be so delivered, stored, and handled as to prevent the inclusion of foreign materials and the damage of materials by water or breakage. Package materials shall be delivered and stored in original packages until ready to be used. Packages or materials showing evidence of water or other damage shall be rejected.
- b. Unless otherwise specified herein, concrete works shall conform to the requirements of the ACI Building Code. Full cooperation shall be given on trades to install embedded



and secured in place by use of metal or concrete supports, spacers and ties. Such supports shall be used in such manner that they will not be exposed or contribute in any way, to the discoloration or deterioration of the concrete.

g. Conveying and Placing Concrete:

- i. Conveying – concrete shall be conveyed from mixer to forms as rapidly as applicable, by methods which will prevent segregation, or loss of ingredients. There will be no vertical drop greater than 1.5 meters except where suitable equipment is provided to prevent segregation and where specifically authorized.
- ii. Placing – concrete shall be worked readily into the corners and angles of the forms and around all reinforcement and imbedded items without permitting the material to segregate, concrete shall be deposited as close as possible to its final position in the forms so that flow within the mass does not exceed two (2) meters and consequently segregation is reduced to a minimum near forms or embedded items, or elsewhere as directed, the discharge shall be so controlled that the concrete may be effectively compacted into horizontal layers not exceeding 30 centimeters in depth within the maximum lateral movement specified.
- iii. Time interval between mixing and placing. Concrete shall be placed before initial set has occurred and before it has contained its water content for more than 45 minutes. No concrete mix shall be placed before 60 complete revolution of the machine mixer.
- iv. Consolidation of Concrete – concrete shall be consolidated with the aid of mechanical vibrating equipment and supplemented by the hand spading and tamping. Vibrators shall not be inserted into lower cured that have commenced initial set; and reinforcement embedded in concrete beginning to set or already set shall not be disturbed by vibrators. Consolidation around major embedded parts shall by hand spading and tamping and vibrators shall not be used.
- v. Placing Concrete through reinforcement – In placing concrete through reinforcement, care shall be taken that no segregation of the coarse aggregate occurs. On the bottom of beams and slabs, where the congestion of steel near the forms makes placing difficult, a layer of mortar of the same cement-sand ratios as used in concrete shall be first deposited to cover the surfaces.

h. Curing

- i. General – All concrete shall be moist cured for a period not less than seven (7) consecutive days by an approved method or combination applicable to local conditions.
- ii. Moist Curing – The surface of the concrete shall be kept continuously wet by covering with burlap plastic or other approved materials thoroughly saturated with water and keeping the covering spraying or intermittent hosing.

i. Finishing

- i. Concrete surfaces shall not be plastered unless otherwise indicated. Exposed concrete surfaces shall be formed with plywood, and after removal of forms, the surfaces shall be smooth, true to line and shall present or finished appearance except for minor defects which can be easily repaired with patching with cement mortar, or can be ground to a smooth surface to remove all joint marks of the form works.
- ii. Concrete Slabs on Fill. The concrete slabs on fill shall be laid on a prepared foundation consisting of sub grade and granular fill with thickness equal to the thickness of the overlaying slab except when indicated.

**B. MASONRY**

- a. **Masonry Units (CHB):**  
100mm thick for exterior walls unless otherwise indicated.  
Use 400 psi for non-load bearing blocks and 700 psi for load bearing blocks where required. Where full height walls are constructed with concrete hollow blocks, these shall extend up to the bottom of beam or slab unless otherwise indicated on plans. Provide stiffener columns & lintel beams as specified in the structural drawings or as specified or as deemed required to assure a stabilized wall due to height & other considerations.
- b. **Sand:**  
S-1, washed, clean and greenish in color.
- c. **Mortar:**  
One part "Portland" cement and two parts sand and water but not more than three parts sand and water.
- d. **Plaster bond:**  
Apply plaster bond to all wall area.

**C. METAL WORK**

- a. **Description**  
Metal works shall conform to the approved plans and to the Standard Specifications.
- b. **Reference Standards**  
Comply with the latest edition of the following as applicable, unless otherwise specified or modified.
  1. **AMERICAN INSTITUTE OF STEEL CONSTRUCTION (AISC), 1978:** Specification for the Design, Fabrication and Erection of Structural Steel for Buildings. Code of Standard Practice for Steel Buildings and Bridges; Specification for Architecturally Exposed Structural Steel.
  2. **AMERICAN WELDING SOCIETY (AWS):** Standard Welding Symbols A2.068; Standard Welding Code D1 1-1973 (Rev 1-73 & 2-74) (To govern if in conflict with AISC)
  3. **RESEARCH COUNCIL ON RIVETED AND BOLTED JOINTS OF THE ENGINEERING FOUNDATION (RCRBJ):** Specification for Structural Joists using ASTM A-325-76s Bolts.
  4. **STRUCTURAL STEEL PAINTING COUNCIL (SSPC):** Painting Manual, Vol. 1; Good Painting Practice, Painting Manual, Vol. 2; Systems and Specifications.
- c. **Source Quality Control**  
Errors of Shop Drawings, fabrication, correct fitting and alignment of the various metal items or component members shall be the responsibility of the Contractor. However, the Contractor shall permit the Architect or an independent inspection agency, if engaged by the Owner, to inspect work in progress in his shop. Such inspections shall not relieve the Contractor of his responsibility to furnish materials and workmanship in accordance with the Contract Documents.
- d. **Product Delivery, Handling and Storage**  
Handle and store in such manner as to prevent damage or disfigurement. Store finished items or components above ground on platforms, pallets or other supports and protect from harmful elements.

- e. **Protection**  
The Contractor shall protect any existing work subject to damage during the installation of the specified work and shall adequately protect specified work during installation.
- f. **Field Quality Control**  
Facilities shall be provided by the Contractor as needed for the proper inspection of the specified work, including temporary platforms, hoists, protective devices, electric current, etc. Improper workmanship, as determined by the Architect shall be corrected and replaced, at no additional cost to the Owner.
- g. **Materials**  
Products shall conform to the respective reference specifications and standards and to the requirements specified herein:
  - 1. **STEEL AND IRON:** If not specified otherwise, use standard mill-finished structural steel shapes or bar iron in compliance with AISC Specifications for Design, Fabrication and Erection of Structural Steel for Buildings.
  - 2. **BOLTS, NUTS, STUDS AND RIVETS:** ASTM A 307 & A 325
  - 3. **SCREWS:** Fed. Spec. FF-S-85, Fed. Spec. FF-S-92, and Fed. Spec. FF-S-111
- h. **Fabrication**  
By mechanics skilled in the trade and in accordance with the manufacturer's directions, Metalwork shall be fabricated to allow for expansion and contraction of materials. Provide welding and bracing of adequate strength and durability, with tight, flush joints, dressed smooth and clean. Complete with bolts and nuts.
- i. **Measurements**  
Before fabrication, provide necessary field measurements and verify all measurements.
- j. **Metal Surfaces**  
Shall be clean and free from all scale, flake, rust, and rust pitting; well-formed and finished to shape and size, with sharp lines, angles and smooth surface. Shearing and punching shall leave clean true lines and surfaces. Weld or rivet permanent connections. Weld and flush rivets shall be used and finished flush smooth on surfaces that will be exposed after installation. Do not use screws or bolts where they can be avoided: when used, heads shall be countersunk, screwed up tight and threads nicked to prevent loosening.
- k. **Construction**  
Thickness of metals and details of assembly and supports shall give ample strength and stiffness for the minimum loads specified or indicated. Joints exposed to weather shall be formed to exclude water.
- l. **Shop Fabrication**  
Fabrication and assembly shall be done in the shop to the greatest extent possible.
- m. **Submittals**  
Shop Drawings. Submit along with catalogue, cuts, templates and erection and installation details, indicating thickness, type, grade, type of metal and dimensions. Show construction details, reinforcement, anchorage, and installation with relation to the construction.
- n. **Qualification of Welders**  
In accordance with AWS D1.1 with procedures, materials and equipment of the type required for the work.

- o. **Delivery and Storage**  
Protect from corrosion, deformation and other types of damage. Store items in an enclosed area free from contact with soil and weather. Contractor shall replace and removed damage items with new items.
- p. **Welding**  
Use welding electrode E70xx and perform welding, welding inspection and corrective welding in accordance with AWS D1.1. Weld in a manner to prevent permanent distortion of the connected parts. Weld continuously along the entire area of contact (except where lack welding is permitted. Do not lack weld exposed to connections.) Grind smooth visible weld in finished installation.
- q. **Metal Purlins**  
Metal purlins shall be of high grade galvanized steel with minimum tensile strength of 275 MPA, 1.2mm in thickness.

#### **IV. ARCHITECTURAL WORKS**

##### **A. PAINTING WORKS**

- a. All primers, thinners and putty, also waterproofing for internal and external application shall be the same brand as the specified material.
- b. Application shall be as per paint Manufacturer's specification and recommendation.
- c. Provide all drop cloth and other covering requisite for protection of floors, walls, aluminum, glass, finishes and other works.
- d. All applications and methods used shall strictly follow the Manufacturer's Instructions and Specifications.
- e. All surfaces including masonry wall shall be thoroughly cleaned, puttied, sandpapered, rubbed and polished; masonry wall shall be treated with Neutralizer.
- f. All exposed finish hardware, lighting fixtures and accessories, glass and the like shall be adequately protected so that these are not stained with paint and other painting materials prior to painting works.
- g. All other surfaces endangered by stains and paint marks should be taped and covered with craft paper.
- h. The application of painting shall be 3 coats

#### **V. SANITARY / PLUMBING WORKS**

- A. Comply with the current applicable codes, ordinances, and regulations of the authority or authorities having jurisdiction, the rules, regulations and requirements of the utility companies (as applicable).
- B. Supply, installation and testing of the following:
  - B.1 Potable water supply system complete in all respects including but not limited to submittals, shop drawings, piping, water meters, valves, bibbs, insulation, all accessories required for complete and operational of the system.
  - B.2 Water service connections including but not limited to water meters, float valves. Any and all other works involve in providing the complete operation of the water supply system.

- B.3 Soil waste and vent system complete in all respect including but not limited to connection to existing sewer, submittals, shop drawings, pipes, fittings, valves, cleanout, drains, etc. Complete and operational.
- B.4 Storm drainage system complete in all respect including but not limited to connection to existing storm drainage, submittals, shop drawings, pipes, fittings, valves, cleanout, drains, etc. Complete and operational.
- C. Workmanship and installation methods shall conform to the best modern practice. Employ skilled tradesmen to perform work under the direct supervision of fully qualified personnel.
- D. All equipment and installations shall meet or exceed minimum requirements of the Standards and Codes as specified in plans and program of work.
- E. Install equipment in strict accordance with manufacturers written recommendations.
- F. Physical sizes of all plant and equipment are to be suitable for the space allocated for the accommodation of such plant and equipment, taking into account the requirement of access for maintenance purposes.
- G. In selecting makes and types of equipment, the Contractor shall ascertain that facilities for proper maintenance, repair and replacement are provided.
- H. Where the Contractor proposes to use an item of equipment other than that specified or detailed in the drawing, which requires any redesign of the system, drawings showing the layout of the equipment and such redesign as required therefore shall be prepared by the Contractor at his own expenses. Where such approved deviation necessitates a different quantity and arrangement of materials and equipment's from that originally specified or indicated in the drawings, the Contractor shall furnish and install any such additional materials and equipment's required by the system at no additional cost.
- I. Equipment catalogue and manufacturer's specifications must be submitted for examination and details shall be submitted for approval before any equipment is to be ordered.
- J. This shall include all information necessary to ascertain the equipment comply with this specification and drawings. Data and sales catalogue of a general nature will not be accepted.
- K. All materials, equipment, components and accessories shall be delivered to the Site in a new condition, properly packed and protected against damage or contamination or distortion, breakage or structural weakening due to handling, adverse weather or other circumstances and, as far as practicable, they shall be kept in the packing cases or under approved protective coverings until required for use.
- L. Any items suffering from damage during manufacture, or in transit, or on site whilst in storage or during erection shall be rejected and replaced without extra cost.
- M. All sanitary fittings and pipework shall be cleaned after installation and keep them in a new condition.
- N. All installed pipelines shall be flushed through with water, rodded when necessary to ensure clearance of debris.
- O. Cleaning and flushing shall be carried out in sections as the installation becomes completed.
- P. The Contractor shall carry out hydraulic test on the complete plumbing systems and the drainage system to show that it is functioning satisfactorily within the requirements of this Specification and local regulations.
- Q. The Contractor shall provide suitable test pumps and arrange for a supply of water required in connection with testing of pipework. The test pump shall be fitted with pressure gauges which shall be of suitable range for the pressure being applied.
- R. Hydraulic tests shall be carried out as the pipework is installed and shall be completed before chases in walls and ducts are closed. Also test shall be carried out prior to false ceilings and other finishes are installed.



- S. Testing apparatus shall be provided by the Contractor. Where any section of pipework or equipment is unable to withstand the maximum pipework test pressure, it shall be isolated during the pipework test then that section of pipework or equipment shall be re-tested at the appropriate test pressure.
- T. The Sanitary Contractor must carry out any additional tests required by the end-user and/or approving agency.
- U. Drainage pipe shall be tested by filling the pipe with 3m. of water higher than the test section and wait for 15 min, then check for leakage at every joints.
- V. Testing of drainage systems shall be carried out in sections by dividing the system horizontally. Each section shall comprise pipework and fitting for three floors/storeys required for testing.
- W. Drainage pressure pipe shall be hydraulic tested at minimum pressure 50 psi.
- X. Hangers and supports for plumbing piping and equipment shall withstand the effects of gravity loads and stresses within limits and under conditions indicated according to ASCE/SEI 7.
- Y. Install hangers and supports to allow controlled thermal and seismic movement of piping systems, to permit freedom of movement between pipe anchors, and to facilitate action of expansion joints, expansion loops, expansion bends, and similar units.
- Z. Install lateral bracing with pipe hangers and supports to prevent swaying.
- AA. Install building attachments within concrete slabs or attach to structural steel. Install additional attachments at concentrated loads, including valves, flanges, and strainers, NPS 2-1/2 (DN 65) and larger and at changes in direction of piping. Install concrete inserts before concrete is placed; fasten inserts to forms and install reinforcing bars through openings at top of inserts.
- BB. Install hangers and supports so that piping live and dead loads and stresses from movement will not be transmitted to connected equipment.
- CC. Install hangers and supports to provide indicated pipe slopes and to not exceed maximum pipe deflections allowed by ASME B31.9 for building services piping.

## VI. ELECTRICAL WORKS

- A. Comply with the current applicable codes, ordinances, and regulations of the authority or authorities having jurisdiction, the rules, regulations and requirements of the utility companies (as applicable).
- B. Drawings, specifications, codes and standards are minimum requirements. Where requirements differ, the more stringent apply.
- C. All equipment and installations shall meet or exceed minimum requirements of the Standards and Codes.
- D. Execute work in strict accordance with the best practices of the trades in a thorough, substantial, workmanlike manner by competent workmen.
- E. When the tests and inspections have been completed, a label shall be attached to all devices tested. The label shall provide the name of the testing company, the date the tests were completed, and the initials of the person who performed the tests.

## F. PANELBOARDS

- F.1 Fabricate and test panelboards according to IEEE 344 to withstand seismic forces defined in Division 16 Sections 16073 and 16074 "Hangers and Supports for Electrical Systems and Vibration and Seismic controls for Electrical Systems" respectively.

- F.2 Enclosures: Flush, Surface, Flush- and surface-mounted cabinets.
- F.2.1 Rated for environmental conditions at installed location.
- i. Indoor Dry and Clean Locations: NEMA 250, Type 1.
  - ii. Outdoor Locations: NEMA 250, Type 3R.
  - iii. Kitchen and Wash-Down Areas: NEMA 250, Type 4X, stainless steel.
  - iv. Other Wet or Damp Indoor Locations: NEMA 250, Type 4.
  - v. Indoor Locations Subject to Dust, Falling Dirt, and Dripping Noncorrosive Liquids: NEMA 250, Type 5 or Type 12.
- F.2.2 Front: Secured to box with concealed trim clamps. For surface-mounted fronts, match box dimensions; for flush-mounted fronts, overlap box.
- F.2.3 Hinged Front Cover: Entire front trim hinged to box and with standard door within hinged trim cover.
- F.2.4 Skirt for Surface-Mounted Panelboards: Same gage and finish as panelboard front with flanges for attachment to panelboard, wall, and ceiling or floor.
- F.2.5 Gutter Extension and Barrier: Same gage and finish as panelboard enclosure; integral with enclosure body. Arrange to isolate individual panel sections.
- F.2.6 Finishes:
- i. Panels and Trim: Steel and galvanized steel, factory finished immediately after cleaning and pretreating with manufacturer's standard two-coat, baked-on finish consisting of prime coat and thermosetting topcoat.
  - ii. Back Boxes: Galvanized steel Same finish as panels and trim.
  - iii. Fungus Proofing: Permanent fungicidal treatment for overcurrent protective devices and other components.
- F.2.7 Directory Card: Inside panelboard door, mounted in transparent card holder metal frame with transparent protective cover.
- F.3 Incoming Mains Location: Top or Bottom.
- F.4 Phase, Neutral, and Ground Buses:
- F.4.1 Material: Hard-drawn copper, 98 percent conductivity.
- F.4.2 Equipment Ground Bus: Adequate for feeder and branch-circuit equipment grounding conductors; bonded to box.
- F.4.3 Neutral Bus: 100 percent of phase bus 4. Extra-Capacity Neutral Bus: Neutral bus rated 200 percent of phase bus and UL listed as suitable for nonlinear loads.

  
 JONATHAN RAYNALD T. ESPINO  
 Planning and Programming Division

  
 JOCELYN A. NAONG  
 Planning and Programming Division

## ***Section VII. Drawings***

*[Insert here a list of Drawings. The actual Drawings, including site plans, should be attached to this section, or annexed in a separate folder.]*

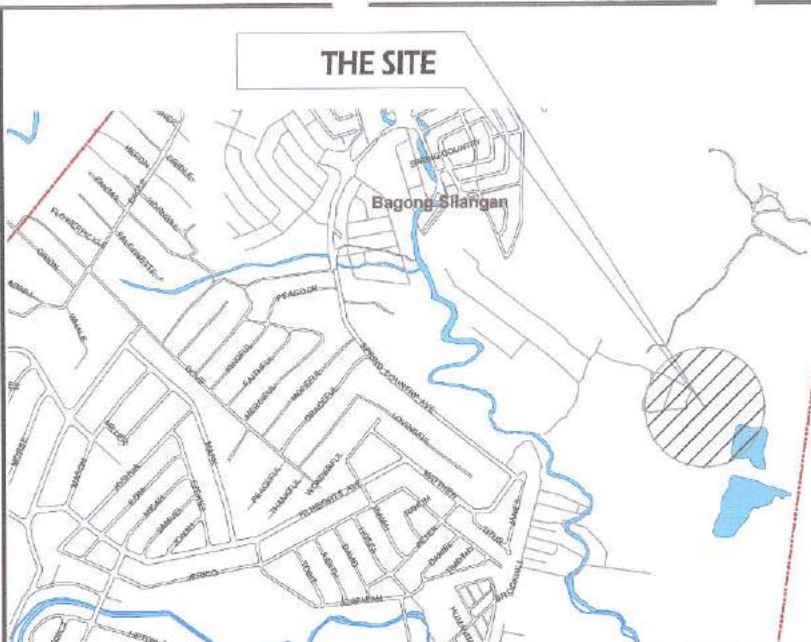

**1** LOCATION PLAN

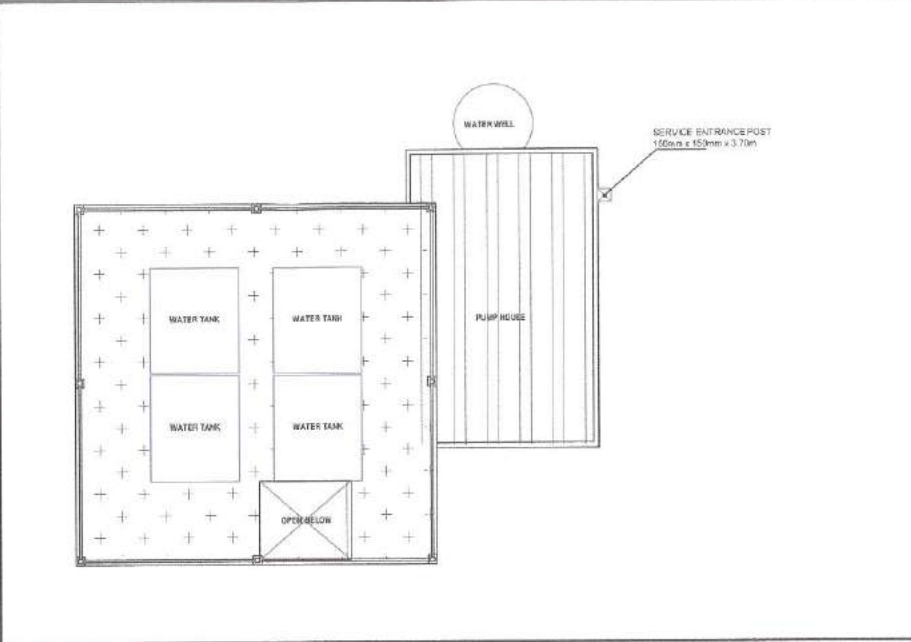

TABLE OF CONTENTS	
<b>ARCHITECTURAL</b>	
AR01	LOCATION MAP, VICINITY MAP, SITE DEVELOPMENT PLAN, PERSPECTIVE
AR02	FLOOR PLAN FOR ELEVATED WATER TANK & PUMP HOUSE, ROOF PLAN FOR PUMP HOUSE, ELEVATION FOR WATER TANK & PUMP HOUSE
<b>STRUCTURAL</b>	
ST01	GENERAL NOTES, SCHEDULE OF COLUMNS & BEAMS, WALL FOOTING DETAIL, SERVICE ENTRANCE POST, SCHEDULE OF FOOTINGS, BEAM TO BEAM CONNECTION DETAIL, BEAM TO COLUMN CONNECTION DETAIL
ST02	FOUNDATION PLAN, ROOF FRAMING PLAN FOR PUMP HOUSE, STRUCTURAL FRAMING PLAN FOR ELEVATED WATER TANK
<b>PLUMBING</b>	
PL01	GENERAL NOTES, LEGENDS AND SYMBOLS, EQUIPMENT SCHEDULE, PUMP LAYOUT, WATER LINE LAYOUT, ELEVATION OF WATER LINE LAYOUT
<b>ELECTRICAL</b>	
EL01	GENERAL NOTES, LIGHTING LAYOUT, POWER LAYOUT, PANEL BOARD DETAIL, SINGLE LINE DIAGRAM



**2** VICINITY MAP

Republika ng Pilipinas  
Lungsod ng Quezon  
**CITY ENGINEERING DEPARTMENT**

PROJECT TITLE:	DRAWN BY:	SUBMITTED BY:	RECOMMENDING APPROVAL:	APPROVED BY:	SHEET CONTENT	SHEET NO.
<b>PROPOSED CONSTRUCTION OF ELEVATED WATER TANK AT GREEN LAND FARM</b>	DATE: May 18, 2021				LOCATION MAP VICINITY MAP SITE DEVELOPMENT PLAN PERSPECTIVE	<b>AR01</b> 1   6
	CHECKED BY:					
LOCATION: BARANGAY BAGONG SILANGAN, DISTRICT 2, QUEZON CITY	REVISION NO.:					

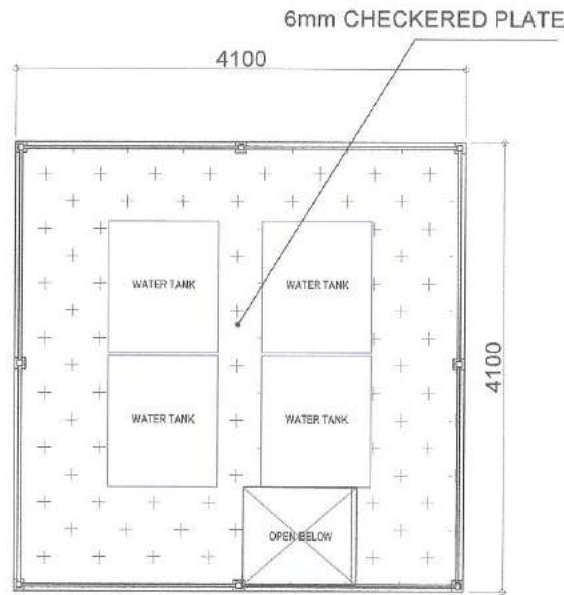

1 FLOOR PLAN FOR ELEVATED WATER TANK

SCALE: 1:50 METERS

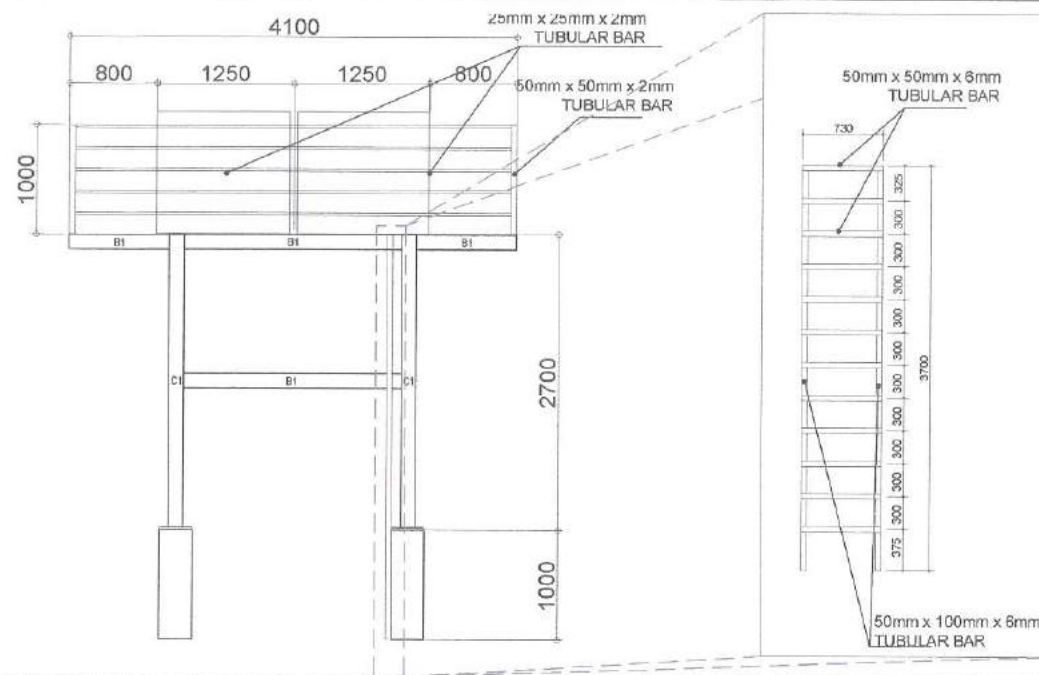

4 ELEVATION FOR ELEVATED WATER TANK

SCALE: 1:50 METERS

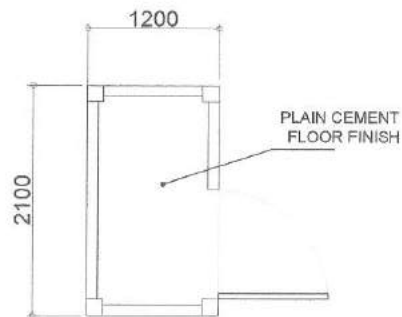

2 PUMP HOUSE FLOOR PLAN

SCALE: 1:50 METERS

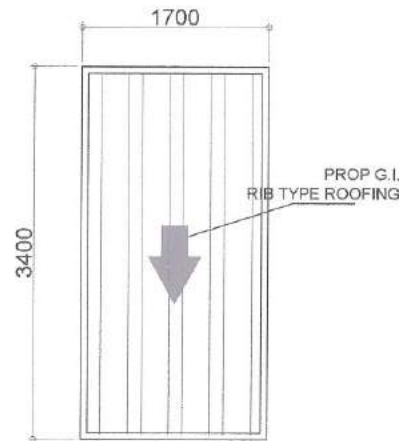

3 ROOF PLAN

SCALE: 1:50 METERS

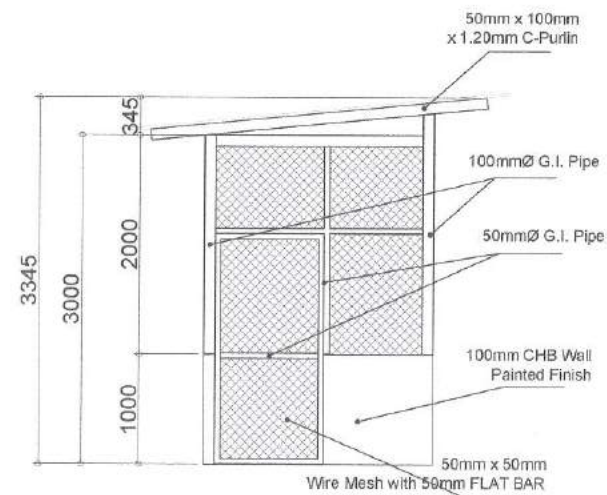

5 ELEVATION OF PUMP HOUSE

SCALE: 1:50 METERS



Republika ng Pilipinas  
Lungsod ng Quezon  
CITY ENGINEERING DEPARTMENT

PROJECT TITLE:  
**PROPOSED CONSTRUCTION OF  
ELEVATED WATER TANK AT GREEN  
LAND FARM**

LOCATION:  
BARANGAY BAGONG SILANGAN, DISTRICT 2, QUEZON CITY

DRAWN BY:  
DATE: May 18, 2021  
CHECKED BY:  
REVISION NO.:

SUBMITTED BY:  
  
**ENGR. LEO S. DEL ROSARIO**  
HEAD, PLANNING & PROGRAMMING DIVISION

RECOMMENDING APPROVAL:  
  
**ENGR. ISAGAN R. VERZOSA, JR.**  
O.C., CITY ENGINEERING DEPARTMENT

APPROVED BY:  
  
**MA. JOSEFINA G. BELMONTE**  
MAYOR O.C.

SHEET CONTENT  
FLOOR PLAN FOR  
ELEVATED WATER  
TANK & PUMP HOUSE  
ROOF PLAN FOR PUMP  
HOUSE  
ELEVATION FOR WATER  
TANK & PUMP HOUSE

SHEET NO.  
  
**AR02  
26**

**GENERAL**

- CONSTRUCTION NOTES AND TYPICAL DETAILS APPLY TO ALL DRAWINGS UNLESS OTHERWISE SHOWN OR NOTED. MODIFY TYPICAL DETAILS AS DIRECTED TO MEET SPECIAL CONDITIONS.
- SHOP DRAWINGS WITH ERECTION AND PLACING DIAGRAMS OF ALL STRUCTURAL FOR ENGINEER'S APPROVAL BEFORE FABRICATION.
- CONTRACTOR SHALL VERIFY ALL DIMENSIONS BEFORE ALL WORK IS TO BEGIN, CHECK WITH MECHANICAL AND ELECTRICAL CONTRACTORS FOR CONDUITS, PIPE SLEEVES, ETC. TO BE EMBEDDED IN CONCRETE.
- IT SHALL BE THE CONTRACTOR'S RESPONSIBILITY TO PROVIDE ADEQUATE BRACINGS AND BRACINGS OF THE STRUCTURE FOR ALL LOADS THAT MAY BE IMPOSED DURING CONSTRUCTION.
- IN CASE OF QUESTION ARISING FROM THE INTERPRETATION OR CONFLICT WITH OTHER DOCUMENTS, THE ATTENTION OF THE OWNER/ENGINEER SHALL BE CALLED IN WRITING.

**CONCRETE & REINFORCEMENT**

- ALL MATERIALS AND WORKMANSHIP SHALL CONFORM WITH THE LATEST BUILDING CODE OF AMERICAN CONCRETE INSTITUTE (ACI-318).
  - ALL CONCRETE SHALL DEVELOP A MINIMUM COMPRESSIVE STRENGTH AT THE END OF TWENTY EIGHT (28) DAYS WITH CORRESPONDING MAXIMUM SIZE AGGREGATE AND SLUMPS AS FOLLOWS:
- | LOCATION   | STRENGTH              | MAX. SIZE OF AGGREGATES | MAX. SLUMP    |
|--|-----------------------|-------------------------|---------------|
| a. SLAB ON GRADE, CURBS, PAVEMENTS, FOOTINGS, WALL FOOTING | 3000 PSI (20 665 Mpa) | 1 in (25mm)             | 4 in. (100mm) |
| b. BEAMS, COLUMNS, SUSPENDED SLAB                          | 4000 PSI (28 665 Mpa) | 3/4 in. (19mm)          | 4 in. (100mm) |
| c. LEAN CONCRETE   | 2500 PSI (17.24 Mpa)  | 1 in (25mm)             | 4 in. (100mm) |

- ALL REINFORCING BARS SHALL CONFORM TO PHSA# GRADE Z75 FOR 12mm Ø AND SMALLER BARS AND GRADE 415 FOR 16mm Ø AND LARGER BARS.
- IN GENERAL, THE LATEST EDITION OF ACI-315, MANUAL OF STANDARD PRACTICE DETAILING REINFORCED CONCRETE STRUCTURES SHALL BE ADHERED TO UNLESS OTHERWISE SHOWN OR NOTED.
- MAINTAIN MINIMUM CONCRETE COVER FOR REINFORCING STEEL AS FOLLOWS:

CONCRETE DEPOSITED DIRECTLY AGAINST GROUND	75 mm
SUSPENDED SLABS	20 mm
SLAB ON GRADE	40 mm
WALLS ABOVE GRADE	25 mm
BEAMS & COLUMNS	40 mm

- SPICES SHALL BE SECURELY WIRE TOGETHER AND SHALL LAP OR JOINT END IN ACCORDANCE WITH TABLE 1 (TABLE OF LAP SPICE AND ANCHORAGE LENGTH) UNLESS OTHERWISE SHOWN ON DRAWINGS. SPICES SHALL BE STAGGERED WHENEVER POSSIBLE.
- ALL ANCHOR BOLTS, DowELS, AND OTHER INSERTS SHALL BE PROPERLY POSITIONED AND SECURED IN PLACE PRIOR TO PLACING OF CONCRETE.
- CONTRACTOR SHALL NOTE AND PROVIDE ALL MISCELLANEOUS CURBS, SILL, STOOLS, EQUIPMENTS, AND MECHANICAL BASES THAT ARE REQUIRED BY THE ARCHITECTURAL, ELECTRICAL, AND MECHANICAL DRAWINGS.
- ALL CONCRETE SHALL BE KEPT MOIST FOR A MINIMUM OF SEVEN (7) CONSECUTIVE DAYS IMMEDIATELY AFTER POURING BY THE USE OF WET BURLAP, FOG SPRAYING, CURING COMPOUNDS OR OTHER APPROVED METHODS.
- STRIPPING OF FORMS AND SHORES:

CONCRETE FOUNDATION	CURING
SUSPENDED SLAB EXCEPT WHEN ADDITIONAL LOADS ARE IMPOSED	24 HRS.
PEDESTAL, COLUMNS, WALLS	8 DAYS
BEAMS	2 DAYS
	21 DAYS

- DEVELOPMENT LENGTH FOR ALL BARS SHALL BE A MINIMUM OF 80 BAR DIAMETER, UNLESS OTHERWISE NOTED.

**STRUCTURAL STEEL AND PLATES**

- ALL STRUCTURAL STEEL SHALL CONFORM TO ASTM (A-36) SPECIFICATIONS WITH MINIMUM YIELD STRENGTH 1/2 (20) MPa
- ANCHOR & FASTENER BOLTS, ALL BOLTS SHALL CONFORM TO ASTM (A-307) SPECIFICATIONS.
- WELDING RODS, ALL WELDING RODS SHALL BE MILD STEEL ELECTRODE LOW HYDROGEN E7018 WITH MINIMUM YIELD STRENGTH > 420 MPa

**FOUNDATION**

- FOUNDATION IS DESIGNED BASED ON NATIONAL BUILDING CODE OF THE PHILIPPINES FOR AN ALLOWABLE SOIL BEARING CAPACITY OF 200 kPa
- FOUNDATION SHALL REST ON NATURAL SOIL UNLESS OTHERWISE NOTED BY THE ENGINEER. NO PART OF THE FOUNDATION SHALL REST ON FILL
- THE CONTRACTOR SHALL NOTIFY THE ENGINEER UPON COMPLETION OF FOUNDATION EXCAVATION FOR ACTUAL SOIL CONDITIONS WHICH DO NOT CONFORM TO THE SOIL BEARING CAPACITY FOR PROPER REVISION

**MASONRY WALLS**

- ALL MATERIALS & WORKMANSHIP SHALL BE IN ACCORDANCE WITH THE APPLICABLE STANDARD & SPECIFICATIONS OF THE STRUCTURAL CODE OF THE PHILIPPINES & UNIFORM BUILDING CODE.
- MORTAR & GROUT FOR ALL CONCRETE MASONRY SHALL CONFORM TO ASTM 270 - TYPE N & SHALL HAVE A MINIMUM OF 28 DAYS STANDARD CYLINDER COMPRESSIVE STRENGTH OF 17.5 MPa (2500 PSI)
- ALL CHS SHALL BE LAID OUT WITH THE CELLS IN UNOBSTRUCTED VERTICAL CONTINUITY. ALL CELLS ESPECIALLY THOSE WITH REINFORCEMENT SHALL BE FILLED WITH MORTAR.
- REINFORCEMENT, AS TABULATED BELOW SHALL BE PROVIDED UNLESS OTHERWISE SPECIFIED IN THE PLAN.
- ALL MASONRY WALLS SHALL BE PROVIDED WITH STIFFENER BEAM BLOCK & STIFFENER AS REQUIRED.
  - FOR HIGH WALLS & EVERY 3000 mm & COLUMN (BOLT) AT 3000 mm ON CENTER
  - FOR DOORS & WINDOWS OPENING PROVIDE LINEAL BEAM SAME AS STIFFENER BEAM BLOCK.

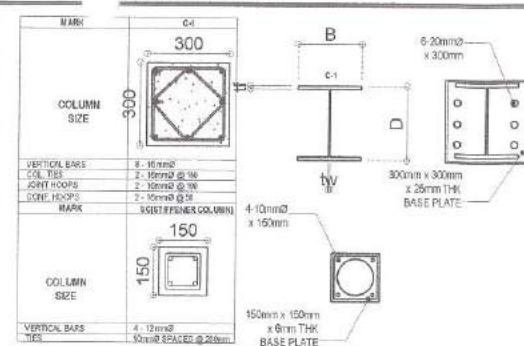
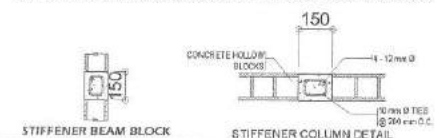

**SCHEDULE OF COLUMN**

NO.	MARK	DIMENSIONS (MM)			
		D	B	t	tr
C1	W3 X 33	293.80	133.40	6.40	5.80

**SCHEDULE OF BEAMS**

MARK	DESIGNATION	DIMENSIONS (MM)			
		D	B	t	tr
B1	W3 X 18	206.80	133.40	6.40	5.80

**2 SCHEDULE OF COLUMN & BEAMS**

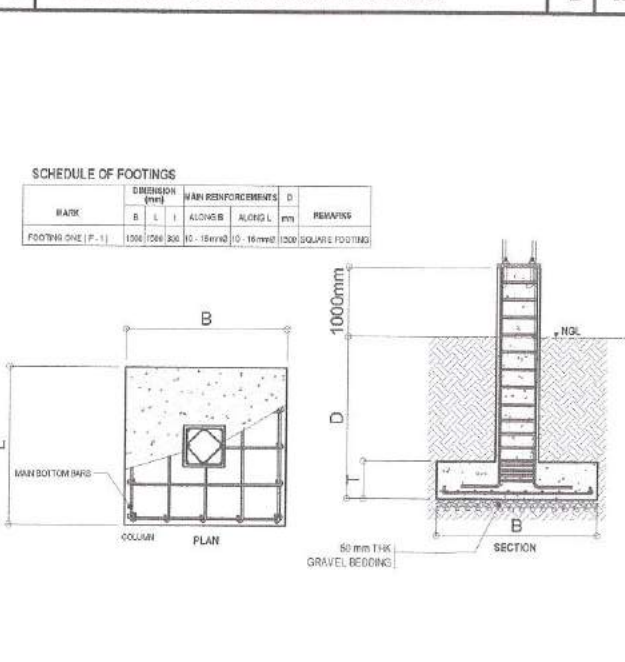

**SCHEDULE OF FOOTINGS**

MARK	DIMENSION (mm)		MAIN REINFORCEMENTS		REMARKS
	B	L	ALONG B	ALONG L	
FOOTING ONE (F-1)	1200	1200	3 @ 18mm	3 @ 16mm	SQUARE FOOTING

**3 WALL FOOTING DETAIL**

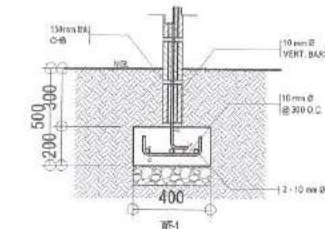

**4 SERVICE ENTRANCE POST**

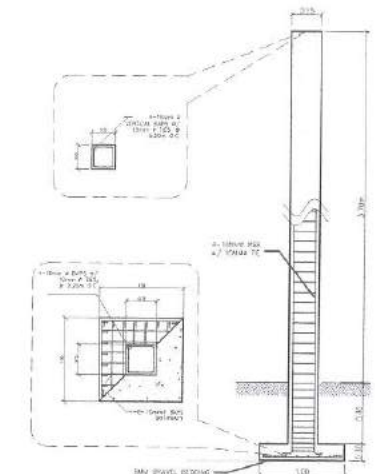

**NOTES:**

- ALL CONNECTIONS ARE FULL WELDS
- THICKNESS OF SHEAR PLATE SAME AS THAT OF CONNECTING COLUMN FLANGE
- THICKNESS OF MOMENT PLATES SAME AS THAT OF CONNECTING BEAM FLANGE
- ONE SIDED CONNECTION IS SHOWN, TWO SIDED IS SIMILAR

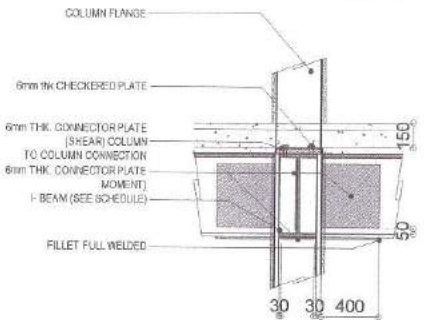

**6 TYPICAL BEAM TO COLUMN CONNECTION**

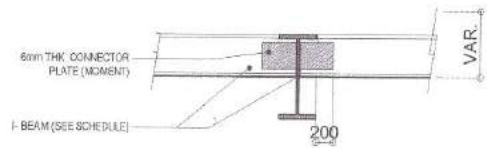

**1 GENERAL NOTES**

**5 SCHEDULE OF FOOTINGS**

**7 TYPICAL BEAM TO COLUMN CONNECTION**

Republika ng Pilipinas  
Lungsod ng Quezon  
**CITY ENGINEERING DEPARTMENT**

PROJECT TITLE: **PROPOSED CONSTRUCTION OF ELEVATED WATER TANK AT GREEN LAND FARM**

BARANGAY BAGONG SILANGAN, DISTRICT 2, QUEZON CITY

DRAWN BY: \_\_\_\_\_

DATE: May 18, 2021

CHECKED BY: \_\_\_\_\_

REVISION NO.: \_\_\_\_\_

SUBMITTED BY: \_\_\_\_\_

**ENGR. LEO S. DEL ROSARIO**  
HEAD, PLANNING & PROGRAMMING DIVISION

RECOMMENDING APPROVAL: \_\_\_\_\_

**ENGR. ISAGANI R. VERZOSA, JR.**  
CITY ENGINEERING DEPARTMENT

APPROVED BY: \_\_\_\_\_

**MA. JOSEFINA G. BELMONTE**  
MAYOR O.C.

SHEET CONTENT: **GENERAL NOTES, SCHEDULE OF COLUMNS & BEAMS, WALL FOOTING DETAIL, SERVICE ENTRANCE POST, SCHEDULE OF FOOTINGS, BEAM TO BEAM CONNECTION DETAIL, BEAM TO COLUMN CONNECTION DETAIL**

SHEET NO. **ST01**  
**3** / **6**

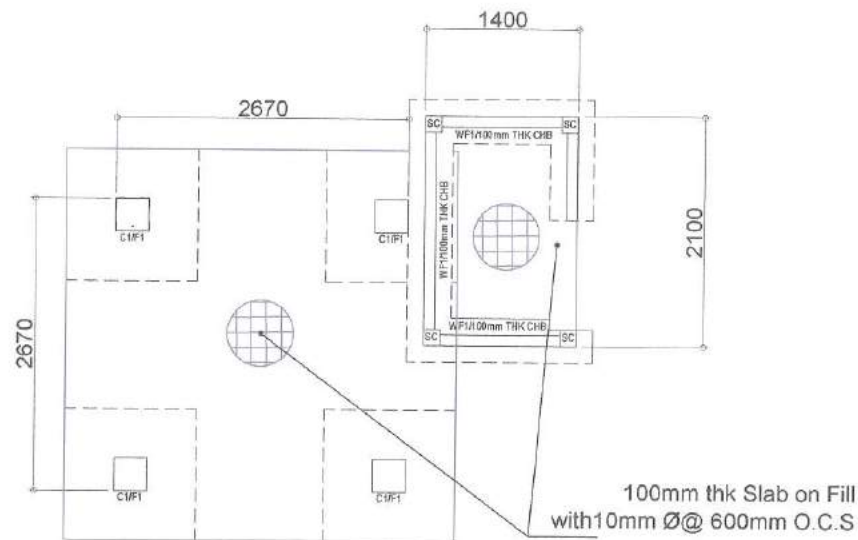

**2 ROOF FRAMING PLAN FOR PUMP HOUSE**

SCALE: 1:50 METERS

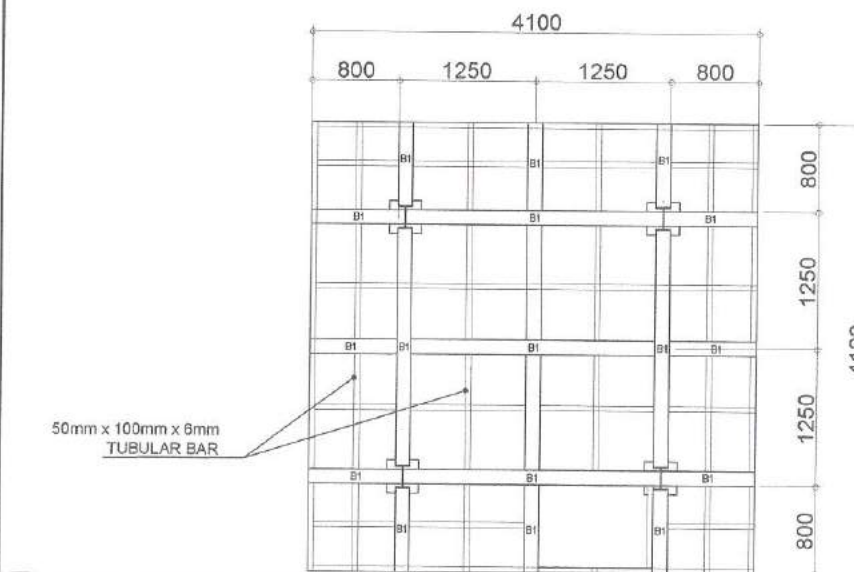
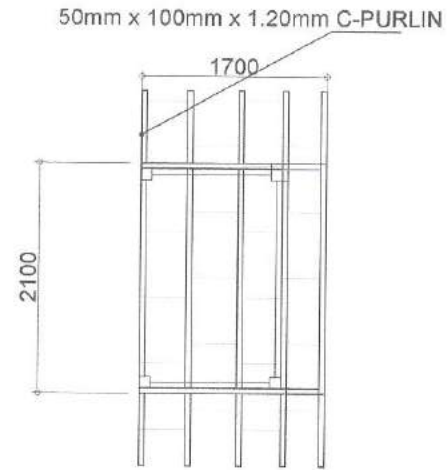

SCALE: 1:100 METERS

**1 FOUNDATION PLAN**

SCALE: 1:50 METERS

**3 STRUCTURAL FRAMING PLAN FOR ELEVATED WATER TANK**



Republika ng Pilipinas  
Lungsod ng Quezon  
**CITY ENGINEERING DEPARTMENT**

PROJECT TITLE :  
**PROPOSED CONSTRUCTION OF  
ELEVATED WATER TANK AT GREEN  
LAND FARM**

LOCATION :  
BARANGAY BAGONG SILANGAN, DISTRICT 2, QUEZON CITY

DRAWN BY:  
DATE: May 18, 2021  
CHECKED BY:  
REVISION NO.:

SUBMITTED BY:  
  
**ENGR. LEO S. DEL ROSARIO**  
HEAD, PLANNING & PROGRAMMING DIVISION

RECOMMENDING APPROVAL:  
  
**ENGR. ISAGANI R. VERZOSA, JR.**  
OIC, CITY ENGINEERING DEPARTMENT

APPROVED BY:  
  
**MA. JOSEFINA G. BELMONTE**  
MAYOR O.C.

SHEET CONTENT  
FOUNDATION PLAN  
ROOF FRAMING PLAN  
FOR PUMP HOUSE  
STRUCTURAL FRAMING PLAN  
FOR ELEVATED WATER TANK

SHEET NO.  
**ST02**  
**4 6**

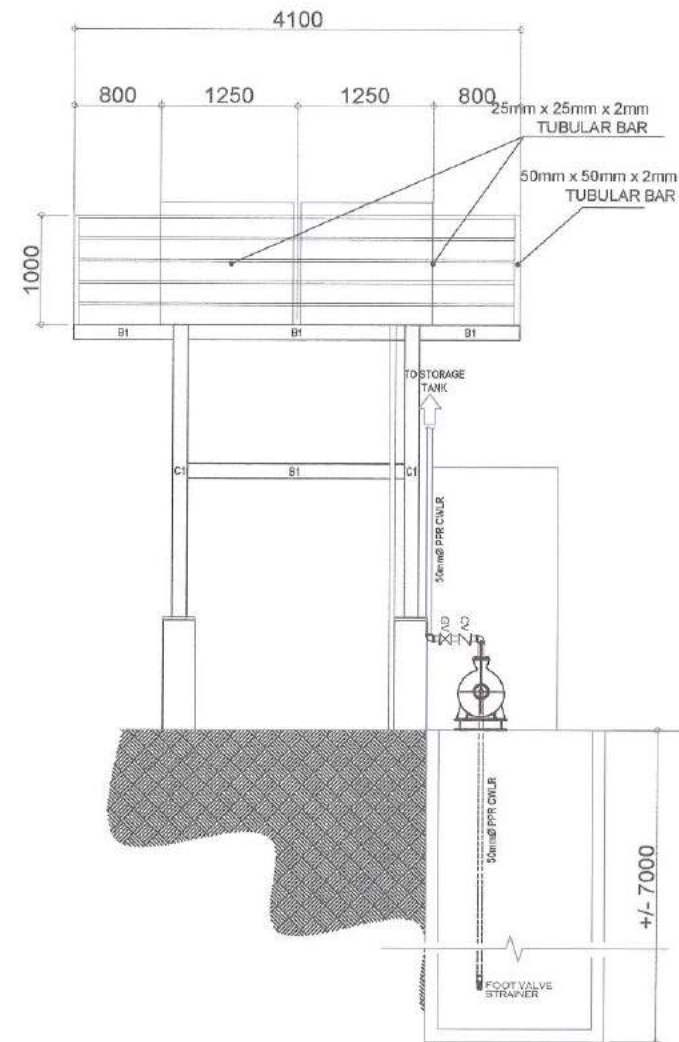
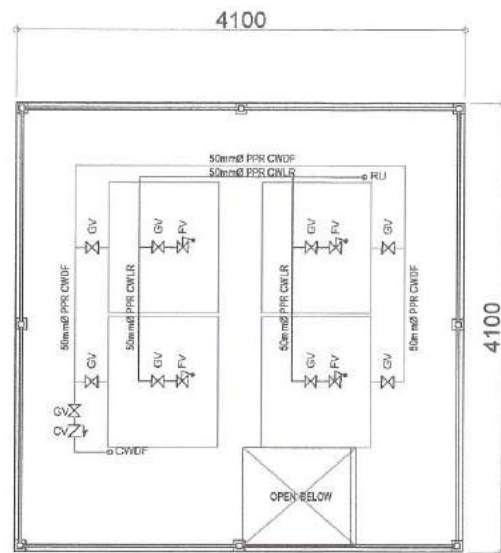
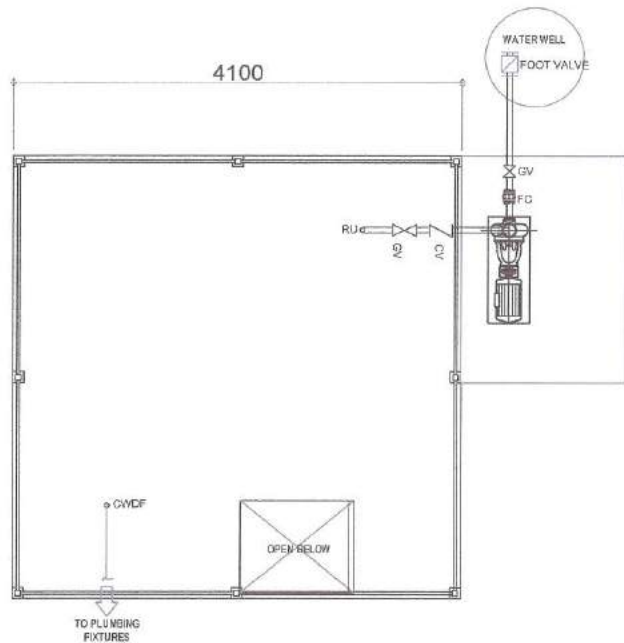

**1 PUMP LAYOUT**

SCALE:  
1:50 METERS

**2 WATER LINE LAYOUT**

SCALE:  
1:50 METERS

**3 ELEVATION OF WATER LINE LAYOUT**

SCALE:  
1:50 METERS



Republika ng Pilipinas  
Lungsod ng Quezon  
**CITY ENGINEERING DEPARTMENT**

PROJECT TITLE:  
**PROPOSED CONSTRUCTION OF  
ELEVATED WATER TANK AT GREEN  
LAND FARM**

LOCATION:  
BARANGAY BAGONG SILANGAN, DISTRICT 2, QUEZON CITY

DRAWN BY:  
DATE: May 17, 2021  
CHECKED BY: ✓  
REVISION NO.:

SUBMITTED BY:  
  
**ENGR. LEO S. DEL ROSARIO**  
HEAD, PLANNING & PROGRAMMING DIVISION

RECOMMENDING APPROVAL:  
  
**ENGR. SAGANI R. VERZOSA, JR.**  
OIC, CITY ENGINEERING DEPARTMENT

APPROVED BY:  
  
**MA. JOSEFINA G. BELMONTE**  
MAYOR O.C.

SHEET CONTENT  
PUMP LAYOUT  
WATER LINE LAYOUT  
ELEVATION OF  
WATER LINE LAYOUT

SHEET NO.  
**PL01**  
**5 6**



- ALL ELECTRICAL WORKS SHALL BE DONE IN ACCORDANCE WITH THE PROVISIONS OF THE LATEST EDITION OF THE PHILIPPINE ELECTRICAL CODE, THE LAWS AND ORDINANCES OF THE LOCAL CODE ENFORCING AUTHORITIES AND THE REQUIREMENTS OF THE LOCAL POWER AND TELEPHONE UTILITY COMPANY.
- ALL EMBEDDED BRANCH CIRCUITS SHALL BE PVC CONDUITS AND FOR EXPOSED INSTALLATION SHALL BE IMC SUPPORTED BY CONDUIT CLAMPS EVERY 700 MILLIMETERS
- PULL BOXES SHALL BE PROVIDED BY THE CONTRACTOR WHENEVER NECESSARY TO FACILITATE WIRE PULLING EVEN IF THESE ARE NOT INDICATED ON THE PLANS. SIZING OF ALL PULLBOXES SHALL BE COMPUTED BASED ON THE CODE REQUIREMENTS. SUBMIT SHOP DRAWINGS TO THE ENGINEER FOR APPROVAL PRIOR TO FABRICATION. LOCATION OF PULLBOXES SHALL BE APPROVED BY THE ARCHITECT/ENGINEER AND MUST BE REFLECTED ON THE "AS-BUILT" PLAN.
- ALL POWER OUTLETS AND SWITCHES SHALL BE GROUNDING TYPE WITH PARALLEL SLOTS FOR 230 V.
- PROVIDE GROUND FAULT CURRENT INTERRUPTER CIRCUIT BREAKER FOR LOADS MARKED "GFCI" ON THE PLAN.
- ALL METALLIC CONDUITS, CABINETS AND EQUIPMENT SHALL BE PROPERLY GROUNDED AND BONDED.
- UNLESS OTHERWISE NOTED, MOUNTING HEIGHT FOR WALL MOUNTED DEVICES SHALL BE AS FOLLOWS:  
 RECEPTACLE OUTLET - 300 MM AFF, 150MM ABOVE WORKING COUNTER.  
 TELEPHONE OUTLET - 300 MM AFF  
 CATV OUTLET - 300 MM AFF  
 LIGHTING SWITCH - 1400 MM AFF  
 PANELBOARD - 1600 MM AFF
- REFER TO MECHANICAL, PLUMBING AND FIRE PROTECTION DRAWINGS FOR RATINGS AND LOCATIONS OF EQUIPMENT AS WELL AS THEIR CONTROL SEQUENCES AS SPECIFIED AND OR SHOWN UNDER THEIR RESPECTIVE SECTIONS.
- ALL MATERIALS TO BE USED SHALL BE OF THE BEST QUALITY, BRAND NEW AS SPECIFIED.
- THE DRAWINGS AND SPECIFICATIONS ARE INTENDED TO PRESENT GENERAL LAYOUT AND BROAD OUTLINE/DESCRIPTION OF THE PROJECT BUT DO NOT NECESSARILY INDICATE/DESCRIBE ACTUAL LOCATIONS, LEVEL AND DISTANCES OF THE EQUIPMENT. THE CONTRACTOR IS HEREBY REQUIRED TO MAKE SUCH ADJUSTMENT AT THE JOBSITE AS LOCATION, DISTANCES AND LEVELS ARE GOVERNED BY ACTUAL FIELD CONDITIONS.
- ANY DISCREPANCY BETWEEN THE PLANS AND SPECIFICATIONS SHALL BE BROUGHT TO THE ATTENTION OF THE ENGINEER FOR CLARIFICATION DECISION.
- ALL LIGHTING AND CONVENIENCE OUTLET CIRCUITS SHALL BE 3.5 SQ. MM. THWN-2 COPPER WIRE UNLESS OTHERWISE NOTED. MINIMUM SIZE OF WIRE SHALL BE 3.5 SQ. MM. COPPER WIRE. ALL WIRES AND CABLES SHALL BE COLOR CODED AS FOLLOWS:  
 PHASE A - RED  
 PHASE B - YELLOW  
 PHASE C - BLACK  
 NEUTRAL - WHITE  
 GROUND - GREEN

- BOXES, WIRE, GUTTERS, ENCLOSURE SHALL BE FABRICATED FROM STEEL WITH THICKNESS AS FOLLOWS:  
 MAXIMUM WIDTH OF THE WIDEST SURFACE STEEL  
 UP TO INCLUDING 152.40 MM  
 OVER 152.40 MM BUT NOT OVER 457.30  
 OVER 457.30 MM BUT NOT OVER 762 MM  
 OVER 762 MM  
 GA  
 GA 16 PAINTED WITH METAL PRIMER EPOXY AND TOPCOAT  
 GA 14 PAINTED WITH METAL PRIMER EPOXY AND TOPCOAT  
 GA 12 PAINTED WITH METAL PRIMER EPOXY AND TOPCOAT  
 GA 10 PAINTED WITH METAL PRIMER EPOXY AND TOPCOAT
- ALL ELECTRICAL WORKS HEREIN SHALL BE EXECUTED BY EXPERIENCED MEN UNDER THE DIRECT SUPERVISION OF A FULL-TIME LICENSED ELECTRICAL ENGINEER AND A DULY ACCREDITED ELECTRICAL CONTRACTOR BY PCAB. WORKS SHALL BE NEATLY PLACED, SECURELY FASTENED AND PROPERLY FINISHED.
- TYPE OF SERVICE ENTRANCE SHALL BE THREE-PHASE, THREE-WIRE PLUS GROUND, 60 HERTZ, 230V AC NOMINAL.
- CONDUITS IN NO CASE SHALL THERE BE MORE THAN THE EQUIVALENT OF FOUR QUARTER BENDS IN ANY ONE RUN. ALL CONDUIT BENDS SHALL BE FIELD MADE BY USING HYDRAULIC BENDERS. MINIMUM BENDING RADIUS MUST BE IN ACCORDANCE TO THE CODE REQUIREMENTS.
- UPON COMPLETION OF ELECTRICAL CONSTRUCTION WORK, INSULATION RESISTANCE TEST AND FUNCTIONALITY TEST SHALL BE PERFORMED BY THE CONTRACTOR INCLUSIVE OF THE INSTALLATION TO BE REPORTED IN DETAILS ON FORMS APPROVED BY THE QUEZON CITY ENGINEERING DEPARTMENT REPRESENTATIVE. THE GROUND RESISTANCE FOR ELECTRICAL SYSTEMS SHALL NOT BE MORE THAN 5 OHMS. COMMUNICATION GROUNDING RESISTANCE SHALL NOT EXCEED 2 OHMS.

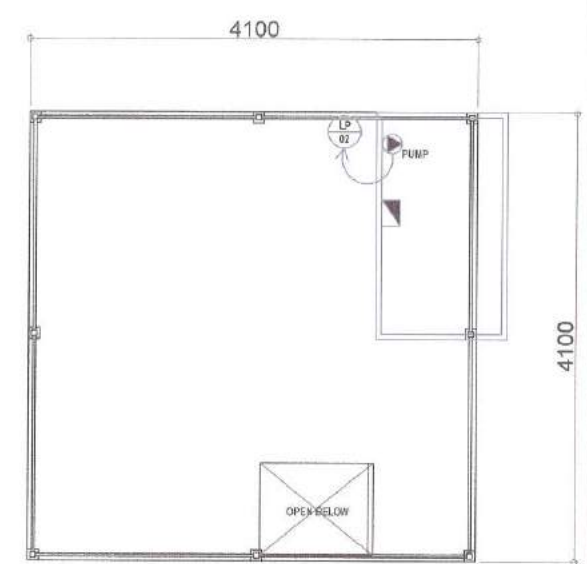
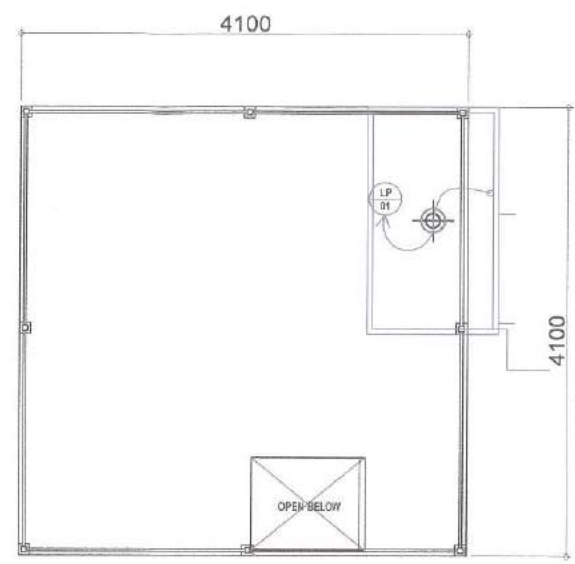

**2 LIGHTING LAYOUT**

**3 POWER LAYOUT**

CIR. NO.	LOAD DESCRIPTION	VOLTS	VA	AMP	OVER CURRENT PROTECTION DEVICE			WIRE	CONDUIT
					RT	AP	P		
1	1-LIGHTING CUBIT	230	183	0.79	15	100	2	R01T-01N	2-3.0mm² THW Wire + 1-2.0mm² THW Wire
2	1-3HP Centrifugal Pump	230	800	3.48	30	100	2	R01T-01N	2-4.0mm² THW Wire + 1-2.0mm² THW Wire
3	Spare				20	100	2	R01T-01N	
4	Spare				20	100	2	R01T-01N	
TOTAL			983.00	3.26					

COMPUTATION:  
 $I_{sc} = \frac{983}{230} = 4.27$   
 $I_{sc} = 5.13A$

OVERCURRENT PROTECTION DEVICE  
 10A, 100MA, 2P, 80% I-CIR CIRCUIT BREAKER

FEEDER SIZE  
 2-4.0mm² THW Wire + 1-2.0mm² THW (G) Wire  
 in 20mm² PVC Conduit

**4 LOAD SCHEDULE**

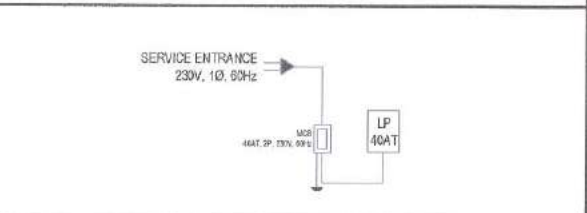
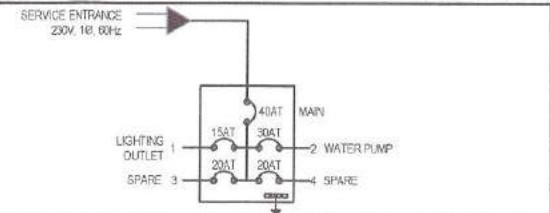

**1 GENERAL NOTES**

**5 PANEL BOARD DETAIL**

**6 SINGLE LINE DIAGRAM**

<p>Republika ng Pilipinas Lungsod ng Quezon <b>CITY ENGINEERING DEPARTMENT</b></p>	PROJECT TITLE:	DRAWN BY:	SUBMITTED BY:	RECOMMENDING APPROVAL:	APPROVED BY:	SHEET CONTENT	SHEET NO.
	PROPOSED CONSTRUCTION OF ELEVATED WATER TANK AT GREEN LAND FARM	DATE: May 14, 2021	<p>ENGR. LEO S. DEL ROSARIO HEAD, PLANNING &amp; PROGRAMMING DIVISION</p>	<p>ENGR. ISAGANI R. VERZOSA, JR. CITY ENGINEERING DEPARTMENT</p>	<p>MA. JOSEFINA G. BELMONTE MAYOR O.C.</p>	GENERAL NOTES LIGHTING LAYOUT POWER LAYOUT PANEL BOARD DETAIL SINGLE LINE DIAGRAM	<p>EL01 6/6</p>
	LOCATION: BARANGAY BAGONG SILANGAN, DISTRICT 2, QUEZON CITY	CHECKED BY:					

## ***Section VIII. Bill of Quantities***

### **Notes on the Bill of Quantities**

#### **Objectives**

The objectives of the Bill of Quantities are:

- a. to provide sufficient information on the quantities of Works to be performed to enable Bids to be prepared efficiently and accurately; and
- b. when a Contract has been entered into, to provide a priced Bill of Quantities for use in the periodic valuation of Works executed.

In order to attain these objectives, Works should be itemized in the Bill of Quantities in sufficient detail to distinguish between the different classes of Works, or between Works of the same nature carried out in different locations or in other circumstances which may give rise to different considerations of cost. Consistent with these requirements, the layout and content of the Bill of Quantities should be as simple and brief as possible.

#### **Daywork Schedule**

A Daywork Schedule should be included only if the probability of unforeseen work, outside the items included in the Bill of Quantities, is high. To facilitate checking by the Entity of the realism of rates quoted by the Bidders, the Daywork Schedule should normally comprise the following:

- a. A list of the various classes of labor, materials, and Constructional Plant for which basic daywork rates or prices are to be inserted by the Bidder, together with a statement of the conditions under which the Contractor will be paid for work executed on a daywork basis.
- b. Nominal quantities for each item of Daywork, to be priced by each Bidder at Daywork rates as Bid. The rate to be entered by the Bidder against each basic Daywork item should include the Contractor's profit, overheads, supervision, and other charges.

#### **Provisional Sums**

A general provision for physical contingencies (quantity overruns) may be made by including a provisional sum in the Summary Bill of Quantities. Similarly, a contingency allowance for possible price increases should be provided as a provisional sum in the Summary Bill of Quantities. The inclusion of such provisional sums often facilitates budgetary approval by avoiding the need to request periodic supplementary approvals as the future need arises. Where such provisional sums or contingency allowances are used, the SCC should state the manner in which they will be used, and under whose authority (usually the Procuring Entity's Representative's).

The estimated cost of specialized work to be carried out, or of special goods to be supplied, by other contractors should be indicated in the relevant part of the Bill of Quantities as a particular provisional sum with an appropriate brief description. A separate procurement procedure is normally carried out by the Procuring Entity to select such specialized contractors. To provide an element of competition among the Bidders in respect of any facilities, amenities, attendance, etc., to be provided by the successful Bidder as prime Contractor for the use and convenience of the specialist contractors, each related provisional sum should be followed by an item in the Bill of Quantities inviting the Bidder to quote a sum for such amenities, facilities, attendance, etc.

### **Signature Box**

A signature box shall be added at the bottom of each page of the Bill of Quantities where the authorized representative of the Bidder shall affix his signature. Failure of the authorized representative to sign each and every page of the Bill of Quantities shall be a cause for rejection of his bid.

These Notes for Preparing a Bill of Quantities are intended only as information for the Procuring Entity or the person drafting the Bidding Documents. They should not be included in the final documents.

**PROJECT TITLE:** PROPOSED CONSTRUCTION OF ELEVATED WATER TANK AT GREEN LAND FARM

**LOCATION :** BARANGAY BAGONG SILANGAN, DISTRICT 2, QUEZON CITY

**PROJECT NO. :** 21 - 000114

**DURATION :** Forty Five (45) Calendar Days

### ***BREAKDOWN OF COST***

	<b>Item of Work (Description)</b>	<b>MATERIALS COST</b>	<b>LABOR COST</b>	<b>INDIRECT COST</b>	<b>AGGREGATE COST</b>
I	GENERAL REQUIREMENTS				
II	SITE WORKS				
III	CIVIL / STRUCTURAL WORKS				
IV	ARCHITECTURAL WORKS				
V	PLUMBING / SANITARY WORKS				
VI	ELECTRICAL WORKS				
VII	UTILITY AND ANCILLARY WORKS				

**TOTAL COST** ₱ \_\_\_\_\_

LUMP SUM BID IN WORDS : \_\_\_\_\_  
\_\_\_\_\_

Contractor : \_\_\_\_\_

**BILL OF QUANTITIES**  
(Building Construction/Rehabilitation Project)

**PROJECT TITLE :** PROPOSED CONSTRUCTION OF ELEVATED WATER TANK AT GREEN LAND FARM

**LOCATION :** BARANGAY BAGONG SILANGAN, DISTRICT 2, QUEZON CITY

**PROJECT NO. :** 21 - 00114

**DURATION :** Forty Five (45) Calendar Days

**Scope of Works:**

- 1 General Requirement include temporary facilities and utilities, billboard, scaffolding, construction safety & health and clearing, hauling and disposal of construction materials & debris
- 2 Site Works include layout and staking, site clearing and preparation, demolition of existing structure, and earthworks.
- 3 Civil and Structural Works include concrete works, masonry works and metal works for water tank platform and pump house
- 4 Architectural Works include floor finishes and painting works for water tank platform and pump house
- 5 Plumbing Works include Installation of sanitary/plumbing roughing-ins, equipment, fixtures and accessories
- 6 Electrical works include Installation of electrical roughing-ins, wirings, devices, fixtures, panelboard and accessories
- 7 Utility and Ancillary works including installation of booster pump, IBC Tank and civil works of service entrance post
- 8 All necessary testing and commissioning shall be performed in accordance to standards.

ITEM NO.	WORK DESCRIPTION & SCOPE OF WORKS	QTY	UNIT	UNIT COST	TOTAL COST
<b>I</b>	<b>GENERAL REQUIREMENTS</b>				
A	Billboard	1	piece	₱	₱
B	Clearing, hauling and disposal of construction materials and debris	1	t.l.		
C	Construction Safety and Health	1	unit		
D	Scaffolding (Rental)	16	sq.m		
E	Temporary enclosure around the construction area (h= 2.4m)	40	l.m.		
F	Temporary lighting & water facilities	45	day		
				<b>Direct Cost I</b>	₱
<b>II</b>	<b>SITE WORKS</b>				
A	Layout and Staking	16	sq.m	₱	₱
B	Site Clearing and Preparation	16	sq.m		
C	Excavation for Structures	15	cu.m		
E	Soil Poisoning/Termite Proofing	20	sq.m		
				Subtotal	₱
F	Gravel bedding	2	cu.m		
				Materials Cost	₱
				Labor Cost	
				Subtotal	₱
G	Backfill and Compaction	12	cu.m		
				Subtotal	₱
				<b>Material Cost II</b>	₱
				<b>Labor Cost II</b>	
				<b>Direct Cost II</b>	₱
<b>III</b>	<b>CIVIL / STRUCTURAL WORKS</b>				

ITEM NO.	WORK DESCRIPTION & SCOPE OF WORKS	QTY	UNIT	UNIT COST	TOTAL COST
A	Concrete Works				
	Site Mix Concrete, 21MPa, 3/4" Gravel				
	Slab on Fill	2	cu.m	₱	₱
	Wall Footing	1	cu.m		
	Stiffener Column	1	cu.m		
	Site Mix Concrete, 28MPa, 3/4" Gravel				
	Column Footing	3	cu.m		
	Column	1	cu.m		
B	Reinforcing Steel Bars				
	Grade 40 Reinforcing Steel Bar including G.I. Tie Wire # 16				
	10mm Ø Column	134	kg		
	10mm Ø Slab on Fill	60	kg		
	10mm Ø Wall Footing	30	kg		
	12mm Ø Stiffener Column	27	kg		
	Grade 60 Reinforcing Steel Bar including G.I. Tie Wire # 16				
	16mm Ø Column Footing	209	kg		
	16mm Ø Column	124	kg		

ITEM NO.	WORK DESCRIPTION & SCOPE OF WORKS	QTY	UNIT	UNIT COST	TOTAL COST
C	Formworks				
	Column	13	sq.m		
	Scaffolding and Shoring				
	Column	9	l.m.		
D	Thermal and Moisture Protection				
	Thermal Protection				
	Vapor Barrier	20	sq.m		
E	Masonry Works				
	Plain Cement Painted Finish (Slab)	20	sq.m		
	100mm CHB Wall Laying, including mortar, reinforcement and two-face plastering	14	sq.m		
F	Metal Works				
	Water Tank Platform				
	Structural Steel Frames for Beams (Wide Flange)	928	kg		
	Structural Steel Frames for Columns (Wide Flange)	285	kg		
	50mm x 150mm x 6mm Tubular Bar	1697	kg		
	50mm x 50mm x 2mm Tubular Bar	38	kg		
	50mm x 50mm x 6mm Tubular Bar	114	kg		
	25mm x 25mm x 2mm Tubular Bar	142	kg		
	1.20m X 2.40m x 6mm Checkered Plate	1086	kg		
	Steel Connection				
	Base Plates for Columns	566	kg		
	Connector Plates for Column to Beam	272	kg		
	Anchor Bolt (A325)				
	10mm Ø	16	piece		
	20mm Ø	24	piece		
	Pump House including door				
	50mm G.I. Pipe, Schedule 40	111	kg		
	100mm G.I. Pipe, Schedule 40	267	kg		
	50mm x 100mm x 1.20mm C - Purlin	34	kg		
	10mmØ Sag Rod	8	kg		
	50mm x 50mm Flat Bar	62	kg		
	50mm x 50mm Wire Mesh	12	sqm		
	Hinge, Heavy Duty	3	piece		
	Miscellaneous & Consumables				
	Acetylene Tank (Refill)	1	tank		
	Assorted Metal Drill Bit	10	piece		
	Cut Off Blade	5	piece		
	Grinding Disc for Metal	4	piece		
	Oxygen Tank (Refill)	2	tank		
	Tekscrew	198	piece		
	Welding Rod	6	box		
G	Roofing Works				
	Pre-Painted Rib-type G.I. Roofing	6	sq.m		
	Pre-Painted G.I. End Flashing	11	lm		
	Tekscrew	16	piece		
	Silicon Sealant	5	tube		
				<b>Material Cost III</b>	<b>₱</b>

ITEM NO.	WORK DESCRIPTION & SCOPE OF WORKS	QTY	UNIT	UNIT COST	TOTAL COST
				<b>Labor Cost III</b>	
				<b>Direct Cost III</b>	₱
<b>IV</b>	<b>ARCHITECTURAL WORKS</b>				
A	Painting Works				
	Epoxy Enamel Paint Finish (Steel Members)	176	sq.m	₱	₱
	Elastomeric Paint Finish (Exterior walls)	14	sq.m		
	Flat Latex Paint Finish (Interior wall)	14	sq.m		
				Material Cost	₱
				Labor Cost	
				Direct Cost	₱
				<b>Material Cost IV</b>	₱
				<b>Labor Cost IV</b>	
				<b>Direct Cost IV</b>	₱
<b>V</b>	<b>PLUMBING / SANITARY WORKS</b>				
	<b>PLUMBING WORKS</b>				
	Waterline				
	50mm Ø, PPR Pipe	12	piece	₱	₱
	50mm Ø, Tee Equal	6	piece		
	50mm Ø, Elbow	11	piece		
	50mm Ø x 40mm Ø, Reducer	2	piece		
	40mm Ø, Flexible Coupling	2	piece		
	50mm Ø, Union Patente	13	piece		
	50mm Ø, Coupling	6	piece		
	50mm Ø, Male Adaptor	36	piece		
	40mm Ø, Male Adaptor	2	piece		
	Valves and Appurtenances				
	50mm Ø, Gate Valve	11	piece		
	50mm Ø, Check Valve	2	piece		
	50mm Ø, Foot Valve, with strainer	4	piece		
	50mm Ø, Float Valve	4	piece		



ITEM NO.	WORK DESCRIPTION & SCOPE OF WORKS	QTY	UNIT	UNIT COST	TOTAL COST
	Miscellaneous & Consumables				
	1000cc All-Around Sealant	1	cans		
	400cc Solvent Cement	1	cans		
	Hacksaw Blade	5	piece		
	Teflon Tape	12	roll		
	Waste Cloth	2	kg		
				<b>Material Cost V</b>	<b>₱</b>
				<b>Labor Cost V</b>	
				<b>Direct Cost V</b>	<b>₱</b>
<b>VI</b>	<b>ELECTRICAL WORKS</b>				
A	Lighting and Power System				
	Roughing-ins				
	20mmØ PVC Pipe	4	piece	₱	₱
	25mmØ PVC Pipe	2	piece		
	25mmØ IMC Pipe	2	piece		
	Pullbox, Junction Box & Utility Box				
	50mm x 100mm Metal Utility Box	2	piece		
	100mm x 100mm Metal Junction Box	1	piece		
	Fittings & Accessories				
	20mmØ PVC Adaptor	12	piece		
	25mmØ PVC Adaptor	4	piece		
	20mmØ IMC Coupling	1	piece		
	20mmØ PVC Locknut & Bushing	12	pair		
	25mmØ PVC Locknut & Bushing	4	pair		
	20mmØ IMC Locknut & Bushing	4	pair		
	20mmØ Entrance Cap Diecast "US"	1	piece		
B	Wires and Cables				
	3.5mm² THHN Wire	30	lm		
	5.5mm² THHN Wire	20	lm		
	2.0mm² THW Wire (Green)	25	lm'		
C	Lighting fixtures (Energy Efficient)				
	150mmØ Lighting Receptacle	1	piece		
	14w LED Bulb	1	piece		
D	Wiring Devices				
	Switch w/ plate & cover, One Gang	1	piece		
	Special Purpose Outlet, Heavy-duty	1	piece		
E	Pipe Hangers & Supports				
	Vertical layout of pipe	4	lm		
F	Miscellaneous & Consumables				
	Electrical Tape	5	roll		
	GI Tie Wire, Ga. 16 (for wire/cable pulling)	2	kg		
	Hacksaw Blade	2	piece		
	Masking Tape	3	roll		
	Pulling Lubricant	1	can		
	Rubber Tape	2	roll		
G	Panelboard				
1	MCB Main: 40AT, 100AF, 2P, Bolt-On, 230V	1	assy		



## ***Section IX. Checklist of Technical and Financial Documents***

### **Notes on the Checklist of Technical and Financial Documents**

The prescribed documents in the checklist are mandatory to be submitted in the Bid, but shall be subject to the following:

- a. GPPB Resolution No. 09-2020 on the efficient procurement measures during a State of Calamity or other similar issuances that shall allow the use of alternate documents in lieu of the mandated requirements; or
- b. any subsequent GPPB issuances adjusting the documentary requirements after the effectivity of the adoption of the PBDs.

The BAC shall be checking the submitted documents of each Bidder against this checklist to ascertain if they are all present, using a non-discretionary “pass/fail” criterion pursuant to Section 30 of the 2016 revised IRR of RA No. 9184.

# Checklist of Technical and Financial Documents

## I. TECHNICAL COMPONENT ENVELOPE

### *Class “A” Documents*

#### Legal Documents

- (a) Valid PhilGEPS Registration Certificate (Platinum Membership) (all pages);  
**and**
- (b) Registration certificate from Securities and Exchange Commission (SEC), Department of Trade and Industry (DTI) for sole proprietorship, or Cooperative Development Authority (CDA) for cooperatives or its equivalent document;  
**and**
- (c) Mayor’s or Business permit issued by the city or municipality where the principal place of business of the prospective bidder is located, or the equivalent document for Exclusive Economic Zones or Areas;  
**and**
- (e) Tax clearance per E.O. No. 398, s. 2005, as finally reviewed and approved by the Bureau of Internal Revenue (BIR).

#### Technical Documents

- (f) Statement of the prospective bidder of all its ongoing government and private contracts, including contracts awarded but not yet started, if any, whether similar or not similar in nature and complexity to the contract to be bid (*please see attached prescribed forms required by the QC – BAC for Infrastructure and Consultancy*); **and**
- (g) Statement of the bidder’s Single Largest Completed Contract (SLCC) similar to the contract to be bid, except under conditions provided under the rules with an attached Notice of Award, Notice to Proceed, Contract and Certificate of Acceptance (*please see attached prescribed form required by the QC – BAC for Infrastructure and Consultancy*); **and**
- (h) Philippine Contractors Accreditation Board (PCAB) License;  
**or**  
Special PCAB License in case of Joint Ventures;  
**and** registration for the type and cost of the contract to be bid; **and**
- (i) Original copy of Bid Security. If in the form of a Surety Bond, submit also a certification issued by the Insurance Commission;  
**or**  
Original copy of Notarized Bid Securing Declaration; **and**
- (j) Project Requirements, which shall include the following:
  - a. Organizational chart for the contract to be bid;
  - b. List of contractor’s key personnel (*e.g.*, Project Manager, Project Engineers, Materials Engineers, and Foremen), to be assigned to the contract to be bid, with their complete qualification and experience data (*please see attached prescribed form required by the QC – BAC for Infrastructure and Consultancy*);
  - c. List of contractor’s major equipment units, which are owned, leased, and/or under purchase agreements, supported by proof of ownership or certification of availability of equipment from the equipment

lessor/vendor for the duration of the project, as the case may be (*please see attached prescribed form required by the QC – BAC for Infrastructure and Consultancy*); **and**

- (k) Original duly signed Omnibus Sworn Statement (OSS); **and** if applicable, Original Notarized Secretary's Certificate in case of a corporation, partnership, or cooperative; or Original Special Power of Attorney of all members of the joint venture giving full power and authority to its officer to sign the OSS and do acts to represent the Bidder.

Additional Technical Requirements:

- Certificate of Site Inspection or Affidavit of Site Inspection as part of Omnibus Sworn Statement
- Affidavit of Undertaking for Key Personnel and Equipment (*please see attached prescribed form required by the QC – BAC for Infrastructure and Consultancy*)
- Equipment Utilization Schedule
- Manpower Schedule
- Construction Schedule and S-Curve
- PERT-CMP
- Construction Methods

#### Financial Documents

- (l) The prospective bidder's audited financial statements, showing, among others, the prospective bidder's total and current assets and liabilities, stamped "received" by the BIR or its duly accredited and authorized institutions, for the preceding calendar year which should not be earlier than two (2) years from the date of bid submission; **and**
- (m) The prospective bidder's computation of Net Financial Contracting Capacity (NFCC) (*please see attached prescribed form required by the QC – BAC for Infrastructure and Consultancy*).

#### **Class "B" Documents**

- (n) If applicable, duly signed joint venture agreement (JVA) in accordance with RA No. 4566 and its IRR in case the joint venture is already in existence; **or** duly notarized statements from all the potential joint venture partners stating that they will enter into and abide by the provisions of the JVA in the instance that the bid is successful.

## **II. FINANCIAL COMPONENT ENVELOPE**

- (o) Original of duly signed and accomplished Financial Bid Form; **and**

#### Other documentary requirements under RA No. 9184

- (p) Original of duly signed Bid Prices in the Bill of Quantities; **and**
- (q) Duly accomplished Detailed Estimates Form, including a summary sheet indicating the unit prices of construction materials, labor rates, and equipment rentals used in coming up with the Bid; **and**
- (r) Cash Flow by Quarter.

**Bid Form for the Procurement of Infrastructure Projects**  
*[shall be submitted with the Bid]*

---

**BID FORM**

Date : \_\_\_\_\_  
Project Identification No. : \_\_\_\_\_

To: *[name and address of Procuring Entity]*

Having examined the Philippine Bidding Documents (PBDs) including the Supplemental or Bid Bulletin Numbers *[insert numbers]*, the receipt of which is hereby duly acknowledged, we, the undersigned, declare that:

- a. We have no reservation to the PBDs, including the Supplemental or Bid Bulletins, for the Procurement Project: *[insert name of contract]*;
- b. We offer to execute the Works for this Contract in accordance with the PBDs;
- c. The total price of our Bid in words and figures, excluding any discounts offered below is: *[insert information]*;
- d. The discounts offered and the methodology for their application are: *[insert information]*;
- e. The total bid price includes the cost of all taxes, such as, but not limited to: *[specify the applicable taxes, e.g. (i) value added tax (VAT), (ii) income tax, (iii) local taxes, and (iv) other fiscal levies and duties]*, which are itemized herein and reflected in the detailed estimates,
- f. Our Bid shall be valid within the a period stated in the PBDs, and it shall remain binding upon us at any time before the expiration of that period;
- g. If our Bid is accepted, we commit to obtain a Performance Security in the amount of *[insert percentage amount]* percent of the Contract Price for the due performance of the Contract, or a Performance Securing Declaration in lieu of the the allowable forms of Performance Security, subject to the terms and conditions of issued GPPB guidelines<sup>1</sup> for this purpose;
- h. We are not participating, as Bidders, in more than one Bid in this bidding process, other than alternative offers in accordance with the Bidding Documents;
- i. We understand that this Bid, together with your written acceptance thereof included in your notification of award, shall constitute a binding contract between us, until a formal Contract is prepared and executed; and
- j. We understand that you are not bound to accept the Lowest Calculated Bid or any other Bid that you may receive.

---

<sup>1</sup> currently based on GPPB Resolution No. 09-2020

- k. We likewise certify/confirm that the undersigned, is the duly authorized representative of the bidder, and granted full power and authority to do, execute and perform any and all acts necessary to participate, submit the bid, and to sign and execute the ensuing contract for the [Name of Project] of the [Name of the Procuring Entity].
  
- l. We acknowledge that failure to sign each and every page of this Bid Form, including the Bill of Quantities, shall be a ground for the rejection of our bid.

Name: \_\_\_\_\_

Legal Capacity: \_\_\_\_\_

Signature: \_\_\_\_\_

Duly authorized to sign the Bid for and behalf of: \_\_\_\_\_

Date: \_\_\_\_\_

## **Bid Securing Declaration Form**

*[shall be submitted with the Bid if bidder opts to provide this form of bid security]*

---

REPUBLIC OF THE PHILIPPINES)  
CITY OF \_\_\_\_\_) S.S.

### **BID SECURING DECLARATION** **Project Identification No.: *[Insert number]***

To: *[Insert name and address of the Procuring Entity]*

I/We, the undersigned, declare that:

1. I/We understand that, according to your conditions, bids must be supported by a Bid Security, which may be in the form of a Bid Securing Declaration.
2. I/We accept that: (a) I/we will be automatically disqualified from bidding for any procurement contract with any procuring entity for a period of two (2) years upon receipt of your Blacklisting Order; and, (b) I/we will pay the applicable fine provided under Section 6 of the Guidelines on the Use of Bid Securing Declaration, within fifteen (15) days from receipt of the written demand by the procuring entity for the commission of acts resulting to the enforcement of the bid securing declaration under Sections 23.1(b), 34.2, 40.1 and 69.1, except 69.1(f), of the IRR of RA No. 9184; without prejudice to other legal action the government may undertake.
3. I/We understand that this Bid Securing Declaration shall cease to be valid on the following circumstances:
  - a. Upon expiration of the bid validity period, or any extension thereof pursuant to your request;
  - b. I am/we are declared ineligible or post-disqualified upon receipt of your notice to such effect, and (i) I/we failed to timely file a request for reconsideration or (ii) I/we filed a waiver to avail of said right; and
  - c. I am/we are declared the bidder with the Lowest Calculated Responsive Bid, and I/we have furnished the performance security and signed the Contract.

IN WITNESS WHEREOF, I/We have hereunto set my/our hand/s this \_\_\_\_ day of *[month]* *[year]* at *[place of execution]*.

*[Insert NAME OF BIDDER OR ITS AUTHORIZED  
REPRESENTATIVE]*  
*[Insert signatory's legal capacity]*  
Affiant

#### **[Jurat]**

*[Format shall be based on the latest Rules on Notarial Practice]*



## **Contract Agreement Form for the Procurement of Infrastructure Projects (Revised)**

*[not required to be submitted with the Bid, but it shall be submitted within ten (10) days after receiving the Notice of Award]*

---

### **CONTRACT AGREEMENT**

THIS AGREEMENT, made this *[insert date]* day of *[insert month]*, *[insert year]* between *[name and address of PROCURING ENTITY]* (hereinafter called the "Entity") and *[name and address of Contractor]* (hereinafter called the "Contractor").

WHEREAS, the Entity is desirous that the Contractor execute *[name and identification number of contract]* (hereinafter called "the Works") and the Entity has accepted the Bid for *[contract price in words and figures in specified currency]* by the Contractor for the execution and completion of such Works and the remedying of any defects therein.

NOW THIS AGREEMENT WITNESSETH AS FOLLOWS:

1. In this Agreement, words and expressions shall have the same meanings as are respectively assigned to them in the Conditions of Contract hereinafter referred to.
2. The following documents as required by the 2016 revised Implementing Rules and Regulations of Republic Act No. 9184 shall be deemed to form and be read and construed as part of this Agreement, viz.:
  - a. Philippine Bidding Documents (PBDs);
    - i. Drawings/Plans;
    - ii. Specifications;
    - iii. Bill of Quantities;
    - iv. General and Special Conditions of Contract;
    - v. Supplemental or Bid Bulletins, if any;
  - b. Winning bidder's bid, including the Eligibility requirements, Technical and Financial Proposals, and all other documents or statements submitted;  
  
Bid form, including all the documents/statements contained in the Bidder's bidding envelopes, as annexes, and all other documents submitted (e.g., Bidder's response to request for clarifications on the bid), including corrections to the bid, if any, resulting from the Procuring Entity's bid evaluation;
  - c. Performance Security;
  - d. Notice of Award of Contract and the Bidder's conforme thereto; and
  - e. Other contract documents that may be required by existing laws and/or the Procuring Entity concerned in the PBDs. **Winning bidder agrees that additional contract documents or information prescribed by the GPPB that are subsequently required for submission after the contract execution, such as the Notice to Proceed, Variation Orders, and Warranty Security, shall likewise form part of the Contract.**
3. In consideration for the sum of *[total contract price in words and figures]* or such other sums as may be ascertained, *[Named of the bidder]* agrees to *[state the object of the contract]* in accordance with his/her/its Bid.

4. The *[Name of the procuring entity]* agrees to pay the above-mentioned sum in accordance with the terms of the Bidding.

IN WITNESS whereof the parties thereto have caused this Agreement to be executed the day and year first before written.

*[Insert Name and Signature] [Insert Name and Signature]*

*[Insert Signatory's Legal Capacity] [Insert Signatory's Legal Capacity]*

*for: for:*

*[Insert Procuring Entity] [Insert Name of Supplier]*

**Acknowledgment**

*[Format shall be based on the latest Rules on Notarial Practice]*

## Omnibus Sworn Statement (Revised)

*[shall be submitted with the Bid]*

---

REPUBLIC OF THE PHILIPPINES )  
CITY/MUNICIPALITY OF \_\_\_\_\_ ) S.S.

### AFFIDAVIT

I, [Name of Affiant], of legal age, [Civil Status], [Nationality], and residing at [Address of Affiant], after having been duly sworn in accordance with law, do hereby depose and state that:

1. *[Select one, delete the other:]*

*[If a sole proprietorship:]* I am the sole proprietor or authorized representative of [Name of Bidder] with office address at [address of Bidder];

*[If a partnership, corporation, cooperative, or joint venture:]* I am the duly authorized and designated representative of [Name of Bidder] with office address at [address of Bidder];

2. *[Select one, delete the other:]*

*[If a sole proprietorship:]* As the owner and sole proprietor, or authorized representative of [Name of Bidder], I have full power and authority to do, execute and perform any and all acts necessary to participate, submit the bid, and to sign and execute the ensuing contract for [Name of the Project] of the [Name of the Procuring Entity], as shown in the attached duly notarized Special Power of Attorney;

*[If a partnership, corporation, cooperative, or joint venture:]* I am granted full power and authority to do, execute and perform any and all acts necessary to participate, submit the bid, and to sign and execute the ensuing contract for [Name of the Project] of the [Name of the Procuring Entity], as shown in the attached [state title of attached document showing proof of authorization (e.g., duly notarized Secretary's Certificate, Board/Partnership Resolution, or Special Power of Attorney, whichever is applicable)];

3. [Name of Bidder] is not "blacklisted" or barred from bidding by the Government of the Philippines or any of its agencies, offices, corporations, or Local Government Units, foreign government/foreign or international financing institution whose blacklisting rules have been recognized by the Government Procurement Policy Board, **by itself or by relation, membership, association, affiliation, or controlling interest with another blacklisted person or entity as defined and provided for in the Uniform Guidelines on Blacklisting;**

4. Each of the documents submitted in satisfaction of the bidding requirements is an authentic copy of the original, complete, and all statements and information provided therein are true and correct;

5. [Name of Bidder] is authorizing the Head of the Procuring Entity or its duly authorized representative(s) to verify all the documents submitted;

6. *[Select one, delete the rest:]*

*[If a sole proprietorship:]* The owner or sole proprietor is not related to the Head of the Procuring Entity, members of the Bids and Awards Committee (BAC), the Technical Working Group, and the BAC Secretariat, the head of the Project Management Office or

the end-user unit, and the project consultants by consanguinity or affinity up to the third civil degree;

*[If a partnership or cooperative:]* None of the officers and members of *[Name of Bidder]* is related to the Head of the Procuring Entity, members of the Bids and Awards Committee (BAC), the Technical Working Group, and the BAC Secretariat, the head of the Project Management Office or the end-user unit, and the project consultants by consanguinity or affinity up to the third civil degree;

*[If a corporation or joint venture:]* None of the officers, directors, and controlling stockholders of *[Name of Bidder]* is related to the Head of the Procuring Entity, members of the Bids and Awards Committee (BAC), the Technical Working Group, and the BAC Secretariat, the head of the Project Management Office or the end-user unit, and the project consultants by consanguinity or affinity up to the third civil degree;

7. *[Name of Bidder]* complies with existing labor laws and standards; and
8. *[Name of Bidder]* is aware of and has undertaken the responsibilities as a Bidder in compliance with the Philippine Bidding Documents, which includes:
  - a. Carefully examining all of the Bidding Documents;
  - b. Acknowledging all conditions, local or otherwise, affecting the implementation of the Contract;
  - c. Making an estimate of the facilities available and needed for the contract to be bid, if any; and
  - d. Inquiring or securing Supplemental/Bid Bulletin(s) issued for the *[Name of the Project]*.
9. *[Name of Bidder]* did not give or pay directly or indirectly, any commission, amount, fee, or any form of consideration, pecuniary or otherwise, to any person or official, personnel or representative of the government in relation to any procurement project or activity.
10. **In case advance payment was made or given, failure to perform or deliver any of the obligations and undertakings in the contract shall be sufficient grounds to constitute criminal liability for Swindling (Estafa) or the commission of fraud with unfaithfulness or abuse of confidence through misappropriating or converting any payment received by a person or entity under an obligation involving the duty to deliver certain goods or services, to the prejudice of the public and the government of the Philippines pursuant to Article 315 of Act No. 3815 s. 1930, as amended, or the Revised Penal Code.**

IN WITNESS WHEREOF, I have hereunto set my hand this \_\_\_ day of \_\_\_, 20\_\_ at \_\_\_\_\_, Philippines.

*[Insert NAME OF BIDDER OR ITS AUTHORIZED REPRESENTATIVE]*

*[Insert signatory's legal capacity]*  
Affiant

**[Jurat]**

*[Format shall be based on the latest Rules on Notarial Practice]*

## Performance Securing Declaration (Revised)

*[if used as an alternative performance security but it is not required to be submitted with the Bid, as it shall be submitted within ten (10) days after receiving the Notice of Award]*

---

REPUBLIC OF THE PHILIPPINES)  
CITY OF \_\_\_\_\_ ) S.S.

### PERFORMANCE SECURING DECLARATION

Invitation to Bid: [Insert Reference Number indicated in the Bidding Documents] To:  
[Insert name and address of the Procuring Entity]

I/We, the undersigned, declare that:

1. I/We understand that, according to your conditions, to guarantee the faithful performance by the supplier/distributor/manufacturee/contractor/consultant of its obligations under the Contract, I/we shall submit a Performance Securing Declaration within a maximum period of ten (10) calendar days from the receipt of the Notice of Award prior to the signing of the Contract.
2. I/We accept that: I/we will be automatically disqualified from bidding for any procurement contract with any procuring entity for a period of one (1) year for the first offense, or two (2) years **for the second offense**, upon receipt of your Blacklisting Order if I/We have violated my/our obligations under the Contract;
3. I/We understand that this Performance Securing Declaration shall cease to be valid upon:
  - a. issuance by the Procuring Entity of the Certificate of Final Acceptance, subject to the following conditions:
    - i. Procuring Entity has no claims filed against the contract awardee;
    - ii. It has no claims for labor and materials filed against the contractor; and
    - iii. Other terms of the contract; or
  - b. replacement by the winning bidder of the submitted PSD with a performance security in any of the prescribed forms under Section 39.2 of the 2016 revised IRR of RA No. 9184 as required by the end-user.

**IN WITNESS WHEREOF**, I/We have hereunto set my/our hand/s this \_\_\_\_ day of [month] [year] at [place of execution].

*[Insert NAME OF BIDDER OR ITS  
AUTHORIZED REPRESENTATIVE]  
[Insert signatory's legal capacity]  
Affiant*

**[Jurat]**

*[Format shall be based on the latest Rules on Notarial Practice]*



**LIST OF ALL AWARDED BUT NOT YET STARTED GOVERNMENT AND PRIVATE CONTRACTS OF THE BIDDER**

**NAME OF CONTRACTOR:** \_\_\_\_\_

**PROJECT TITLE:** \_\_\_\_\_

PROJECT TITLE & EXACT LOCATION	MAJOR SCOPE OF WORKS & DATE STARTED	NAME AND ADDRESS OF PROJECT OWNER	CONTRACT PRICE (PHP) AS AWARDED	DATE OF SCHEDULED COMPLETION	ROLE OF BIDDER <u>IN THE CONTRACT SOLE CONTRACTOR / SUB-CONTRACTOR/PARTNER IN A</u>
	TOTAL AMOUNT OF CONTRACT (Php)				

**SINGLE LARGEST COMPLETED CONTRACT SIMILAR TO THE CONTRACT TO BE BID**

**NAME OF CONTRACTOR:** \_\_\_\_\_

**PROJECT TITLE:** \_\_\_\_\_

PROJECT TITLE (Name of the Contract) & EXACT PROJECT LOCATION	DATE OF CONTRACT	CONTRACT DURATION	PROJECT OWNER & POSTAL ADDRESS	NATURE OF WORK	CONTRACTOR'S ROLE (SOLE CONTRACTOR, SUBCONTRACTOR, PARTNER IN A JV) and PERCENTAGE OF PARTICIPATION	TOTAL CONTRACT VALUE AT AWARD	DATE OF COMPLETION or ESTIMATED COMPLETION TIME	TOTAL CONTRACT VALUE AT COMPLETION IF APPLICABLE



**LIST OF MAJOR EQUIPMENT TO BE USED FOR THE PROJECT**

**NAME OF CONTRACTOR:** \_\_\_\_\_

**PROJECT TITLE:** \_\_\_\_\_

TYPE	DESCRIPTION / CAPACITY	SERIAL NO.	YEAR ACQUIRED	PRESENT LOCATION (SPECIFIC ADDRESS)	STATUS OF AVAILABILITY (OWNED/LEASED)

**A. LIST OF KEY CONSTRUCTION PERSONNEL TO BE ASSIGNED TO THE PROJECT**

**NAME OF CONTRACTOR:** \_\_\_\_\_

**PROJECT TITLE:** \_\_\_\_\_

NAME	POSITION	AGE	EDUCATIONAL ATTAINMENT	TYPE OF CONSTRUCTION EXPERIENCE	NO.OF YEARS WITH THE CONTRACTOR	PROFESSION	PRC NO.

## COMPUTATION OF NET FINANCIAL CONTRACTING CAPACITY (NFCC)

NAME OF BIDDER: \_\_\_\_\_

CURRENT ASSETS*		PHP	_____
(LESS) CURRENT LIABILITIES*	(LESS)	PHP	_____
NETWORTH		PHP	_____
NETWORTH x 15	x 15	PHP	_____
(LESS) VALUE OF ALL OUTSTANDING ON-GOING CONTRACTS**	(LESS)	PHP	_____
(LESS) VALUE OF ALL AWARDED BUT NOT YET STARTED CONTRACTS AS OF DATE**	(LESS)	PHP	_____
<b>NET FINANCIAL CONTRACTING CAPACITY</b>		PHP	_____

NOTES: \* CURRENT ASSETS AND LIABILITIES BASED ON AUDITED FINANCIAL STATEMENT FOR THE PRECEDING CALENDAR YEAR SUBMITTED TO B.I.R.

\*\* BASED ON LIST OF ON-GOING AND AWARDED BUT NOT YET STARTED CONTRACTS SUBMITTED

REPUBLIC OF THE PHILIPPINES)

\_\_\_\_\_ ) S. S.

**AFFIDAVIT OF UNDERTAKING**

I, \_\_\_\_\_, of legal age, Filipino, \_\_\_\_\_ [OFFICER OR REPRESENTATIVE]

with office address at \_\_\_\_\_ after having been duly sworn to in accordance with law, hereby voluntary depose and state:

That I am duly authorized representative of the [Name of Bidder] to execute this undertaking as evidenced by Secretary's Certificate and Board Resolution.

That [Name of Bidder] bidding for the (Name of Project)

That relative to the aforementioned Project, the [Name of Bidder] hereby undertake that the equipment to be use and the key personnel to be assign shall exclusively be used and will only perform to the said project until its completion.

That I am executing this affidavit to attest to the truth of the foregoing and in compliance with the submission of the technical requirements for the public bidding of the said project.

IN WITNESS HEREOF, I have hereunto signed my name below this \_\_\_\_\_ day of \_\_\_\_\_ at \_\_\_\_\_.

AFFIANT FURTHER SAYETH NAUGHT.

\_\_\_\_\_  
Affiant

SUBSCRIBED AND SWORN TO BEFORE ME this \_\_\_ day of \_\_\_\_\_  
\_\_\_\_\_ in \_\_\_\_\_,

affiant exhibiting to me his/her \_\_\_\_\_ issued at \_\_\_\_\_ on \_\_\_\_\_.

Doc. No. ;  
Page No. ;  
Book No. ;  
Series of 2020

\_\_\_\_\_  
Notary Public

