

**PHILIPPINE BIDDING DOCUMENTS**

**Procurement of  
INFRASTRUCTURE  
PROJECTS**

Government of the Republic of the Philippines

**PROPOSED CONSTRUCTION OF REINFORCED  
CONCRETE RETAINING WALL AT KAINGIN I BUNGAD**

**Project number:  
21-00217**

**Sixth Edition  
July 2020**

# Preface

These Philippine Bidding Documents (PBDs) for the procurement of Infrastructure Projects (hereinafter referred to also as the “Works”) through Competitive Bidding have been prepared by the Government of the Philippines for use by all branches, agencies, departments, bureaus, offices, or instrumentalities of the government, including government-owned and/or -controlled corporations, government financial institutions, state universities and colleges, local government units, and autonomous regional government. The procedures and practices presented in this document have been developed through broad experience, and are for mandatory use in projects that are financed in whole or in part by the Government of the Philippines or any foreign government/foreign or international financing institution in accordance with the provisions of the 2016 revised Implementing Rules and Regulations (IRR) of Republic Act (RA) No. 9184.

The PBDs are intended as a model for admeasurements (unit prices or unit rates in a bill of quantities) types of contract, which are the most common in Works contracting.

The Bidding Documents shall clearly and adequately define, among others: (i) the objectives, scope, and expected outputs and/or results of the proposed contract; (ii) the eligibility requirements of Bidders; (iii) the expected contract duration; and (iv) the obligations, duties, and/or functions of the winning Bidder.

Care should be taken to check the relevance of the provisions of the PBDs against the requirements of the specific Works to be procured. If duplication of a subject is inevitable in other sections of the document prepared by the Procuring Entity, care must be exercised to avoid contradictions between clauses dealing with the same matter.

Moreover, each section is prepared with notes intended only as information for the Procuring Entity or the person drafting the Bidding Documents. They shall not be included in the final documents. The following general directions should be observed when using the documents:

- a. All the documents listed in the Table of Contents are normally required for the procurement of Infrastructure Projects. However, they should be adapted as necessary to the circumstances of the particular Project.
- b. Specific details, such as the “*name of the Procuring Entity*” and “*address for bid submission*,” should be furnished in the Instructions to Bidders, Bid Data Sheet, and Special Conditions of Contract. The final documents should contain neither blank spaces nor options.
- c. This Preface and the footnotes or notes in italics included in the Invitation to Bid, BDS, General Conditions of Contract, Special Conditions of Contract, Specifications, Drawings, and Bill of Quantities are not part of the text of the final document, although they contain instructions that the Procuring Entity should strictly follow.
- d. The cover should be modified as required to identify the Bidding Documents as to the names of the Project, Contract, and Procuring Entity, in addition to date of issue.

- e. Modifications for specific Procurement Project details should be provided in the Special Conditions of Contract as amendments to the Conditions of Contract. For easy completion, whenever reference has to be made to specific clauses in the Bid Data Sheet or Special Conditions of Contract, these terms shall be printed in bold typeface on Sections I (Instructions to Bidders) and III (General Conditions of Contract), respectively.
- f. For guidelines on the use of Bidding Forms and the procurement of Foreign-Assisted Projects, these will be covered by a separate issuance of the Government Procurement Policy Board.

# TABLE OF CONTENTS

<b>Glossary of Terms, Abbreviations, and Acronyms.....</b>	<b>5</b>
<b>Section I. Invitation to Bid .....</b>	<b>8</b>
<b>Section II. Instructions to Bidders.....</b>	<b>9</b>
1. Scope of Bid.....	10
2. Funding Information .....	10
3. Bidding Requirements.....	10
4. Corrupt, Fraudulent, Collusive, Coercive, and Obstructive Practices .....	10
5. Eligible Bidders.....	11
6. Origin of Associated Goods .....	11
7. Subcontracts .....	11
8. Pre-Bid Conference.....	12
9. Clarification and Amendment of Bidding Documents.....	12
10. Documents Comprising the Bid: Eligibility and Technical Components.....	12
11. Documents Comprising the Bid: Financial Component .....	13
12. Alternative Bids .....	13
13. Bid Prices .....	13
14. Bid and Payment Currencies.....	13
15. Bid Security.....	14
16. Sealing and Marking of Bids.....	14
17. Deadline for Submission of Bids .....	14
18. Opening and Preliminary Examination of Bids .....	14
19. Detailed Evaluation and Comparison of Bids.....	14
20. Post Qualification.....	15
21. Signing of the Contract .....	15
<b>Section III. Bid Data Sheet.....</b>	<b>16</b>
<b>Section IV. General Conditions of Contract .....</b>	<b>19</b>
1. Scope of Contract.....	20
2. Sectional Completion of Works .....	20
3. Possession of Site.....	20
4. The Contractor’s Obligations.....	20
5. Performance Security .....	20
6. Site Investigation Reports .....	21

7.	Warranty.....	21
8.	Liability of the Contractor.....	21
9.	Termination for Other Causes.....	21
10.	Dayworks .....	21
11.	Program of Work.....	22
12.	Instructions, Inspections and Audits .....	22
13.	Advance Payment.....	22
14.	Progress Payments .....	22
15.	Operating and Maintenance Manuals.....	22
	<b>Section V. Special Conditions of Contract.....</b>	<b>24</b>
	<b>Section VI. Specifications .....</b>	<b>26</b>
	<b>Section VII. Drawings.....</b>	<b>28</b>
	<b>Section VIII. Bill of Quantities .....</b>	<b>29</b>
	<b>Section IX. Checklist of Technical and Financial Documents.....</b>	<b>31</b>

# *Glossary of Terms, Abbreviations, and Acronyms*

**ABC** – Approved Budget for the Contract.

**ARCC** – Allowable Range of Contract Cost.

**BAC** – Bids and Awards Committee.

**Bid** – A signed offer or proposal to undertake a contract submitted by a bidder in response to and in consonance with the requirements of the bidding documents. Also referred to as *Proposal* and *Tender*. (2016 revised IRR, Section 5[c])

**Bidder** – Refers to a contractor, manufacturer, supplier, distributor and/or consultant who submits a bid in response to the requirements of the Bidding Documents. (2016 revised IRR, Section 5[d])

**Bidding Documents** – The documents issued by the Procuring Entity as the bases for bids, furnishing all information necessary for a prospective bidder to prepare a bid for the Goods, Infrastructure Projects, and/or Consulting Services required by the Procuring Entity. (2016 revised IRR, Section 5[e])

**BIR** – Bureau of Internal Revenue.

**BSP** – Bangko Sentral ng Pilipinas.

**CDA** – Cooperative Development Authority.

**Consulting Services** – Refer to services for Infrastructure Projects and other types of projects or activities of the GOP requiring adequate external technical and professional expertise that are beyond the capability and/or capacity of the GOP to undertake such as, but not limited to: (i) advisory and review services; (ii) pre-investment or feasibility studies; (iii) design; (iv) construction supervision; (v) management and related services; and (vi) other technical services or special studies. (2016 revised IRR, Section 5[i])

**Contract** – Refers to the agreement entered into between the Procuring Entity and the Supplier or Manufacturer or Distributor or Service Provider for procurement of Goods and Services; Contractor for Procurement of Infrastructure Projects; or Consultant or Consulting Firm for Procurement of Consulting Services; as the case may be, as recorded in the Contract Form signed by the parties, including all attachments and appendices thereto and all documents incorporated by reference therein.

**Contractor** – is a natural or juridical entity whose proposal was accepted by the Procuring Entity and to whom the Contract to execute the Work was awarded. Contractor as used in these Bidding Documents may likewise refer to a supplier, distributor, manufacturer, or consultant.

**CPI** – Consumer Price Index.

**DOLE** – Department of Labor and Employment.

**DTI** – Department of Trade and Industry.

**Foreign-funded Procurement or Foreign-Assisted Project** – Refers to procurement whose funding source is from a foreign government, foreign or international financing institution as specified in the Treaty or International or Executive Agreement. (2016 revised IRR, Section 5[b]).

**GFI** – Government Financial Institution.

**GOCC** – Government-owned and/or –controlled corporation.

**Goods** – Refer to all items, supplies, materials and general support services, except Consulting Services and Infrastructure Projects, which may be needed in the transaction of public businesses or in the pursuit of any government undertaking, project or activity, whether in the nature of equipment, furniture, stationery, materials for construction, or personal property of any kind, including non-personal or contractual services such as the repair and maintenance of equipment and furniture, as well as trucking, hauling, janitorial, security, and related or analogous services, as well as procurement of materials and supplies provided by the Procuring Entity for such services. The term “related” or “analogous services” shall include, but is not limited to, lease or purchase of office space, media advertisements, health maintenance services, and other services essential to the operation of the Procuring Entity. (2016 revised IRR, Section 5[r])

**GOP** – Government of the Philippines.

**Infrastructure Projects** – Include the construction, improvement, rehabilitation, demolition, repair, restoration or maintenance of roads and bridges, railways, airports, seaports, communication facilities, civil works components of information technology projects, irrigation, flood control and drainage, water supply, sanitation, sewerage and solid waste management systems, shore protection, energy/power and electrification facilities, national buildings, school buildings, hospital buildings, and other related construction projects of the government. Also referred to as *civil works or works*. (2016 revised IRR, Section 5[u])

**LGUs** – Local Government Units.

**NFCC** – Net Financial Contracting Capacity.

**NGA** – National Government Agency.

**PCAB** – Philippine Contractors Accreditation Board.

**PhilGEPS** - Philippine Government Electronic Procurement System.

**Procurement Project** – refers to a specific or identified procurement covering goods, infrastructure project or consulting services. A Procurement Project shall be described, detailed, and scheduled in the Project Procurement Management Plan prepared by the agency which shall be consolidated in the procuring entity's Annual Procurement Plan. (GPPB Circular No. 06-2019 dated 17 July 2019)

**PSA** – Philippine Statistics Authority.

**SEC** – Securities and Exchange Commission.

**SLCC** – Single Largest Completed Contract.

**UN** – United Nations.



## ***Section I. Invitation to Bid***

### **Notes on the Invitation to Bid**

The Invitation to Bid (IB) provides information that enables potential Bidders to decide whether to participate in the procurement at hand. The IB shall be posted in accordance with Section 21.2 of the 2016 revised IRR of RA No. 9184.

Apart from the essential items listed in the Bidding Documents, the IB should also indicate the following:

- a. The date of availability of the Bidding Documents, which shall be from the time the IB is first advertised/posted until the deadline for the submission and receipt of bids;
- b. The place where the Bidding Documents may be acquired or the website where it may be downloaded;
- c. The deadline for the submission and receipt of bids; and
- d. Any important bid evaluation criteria.

The IB should be incorporated into the Bidding Documents. The information contained in the IB must conform to the Bidding Documents and in particular to the relevant information in the Bid Data Sheet.



**REPUBLIC OF THE PHILIPPINES**  
**QUEZON CITY GOVERNMENT**  
**BIDS AND AWARDS COMMITTEE FOR INFRASTRUCTURE &**  
**CONSULTANCY**



2<sup>nd</sup> floor, Finance Building, Procurement Department, Quezon City Hall Complex, Elliptical Road, Quezon City

December 3, 2021

## Invitation to Bid

No	Project No.	Project Name	Location	Amount	Durati on Cal. Days	Office	Source Fund
<b><u>Bridge – Small B</u></b>							
1	21-00216	Proposed Rehabilitation of Steel Bridge at Morning Star Street	Payatas	2,402,736.00	90	Engineering Department	Engineering Department
<b><u>Flood Control – Small B</u></b>							
2	21-00217	Proposed Construction of Reinforced Concrete Retaining Wall at Kaingin 1 Bungad	Pansol	4,790,032.81	120	Engineering Department	Engineering Department-SB No. 1
<b><u>Parks – Small B</u></b>							
3	21-00218	Proposed Improvement of Sports and Recreational Park along William Extension, Pilarville Subdivision	Tandang Sora	10,702,334.95	150	Parks Department	Engineering Department-SB No. 1
<b><u>Roads – Small B</u></b>							
4	21-00219	Proposed Rehabilitation of Alley and Drainage of Halili Alleys	Krus Na Ligas	1,307,187.66	90	Engineering Department	Engineering Department
5	21-00220	Proposed Rehabilitation of Road and Drainage of Interior Armando Street	Bagbag	3,005,334.22	90	Engineering Department	Engineering Department
6	21-00221	Proposed Rehabilitation (Surface Improvement) at Spencer and Manhattan Street	Immaculate Concepcion	3,594,941.38	90	Engineering Department	Engineering Department
7	21-00222	Proposed Rehabilitation of Drainage System at Ermin Garcia Street (Albany-15th Avenue)	Silangan	4,254,217.75	90	Engineering Department	Engineering Department-SB No. 1
8	21-00223	Proposed Rehabilitation (Surface Improvement) of Various Streets at Pook Dagohoy	UP Campus	4,720,456.27	35	Engineering Department	Engineering Department
9	21-00224	Proposed Rehabilitation of Road and Drainage at Asprer Street	Payatas	4,852,646.66	90	Engineering Department	Engineering Department
10	21-00225	Proposed Rehabilitation of Road and Drainage at Opel Street	Fairview	6,225,364.30	120	Engineering Department	Engineering Department

11	21-00226	Proposed Rehabilitation of Road and Drainage at Assistant and Accounting Streets	Bahay Toro	9,537,716.75	150	Engineering Department	Engineering Department
12	21-00227	Proposed Rehabilitation of Road and Drainage at Visayas Extension and Zamboanga Streets	Payatas	21,230,207.33	180	Engineering Department	Engineering Department
<b><u>Roads – Medium A</u></b>							
13	21-00228	Proposed Rehabilitation of Road and Drainage at Peso, Yuan, Dinar and Schilling Streets	North Fairview	93,315,411.39	330	Engineering Department	Engineering Department
<b><u>Buildings – Medium A (Specialty-Electrical Works)</u></b>							
14	21-00229	Proposed Construction and Installation of Streetlight posts at Barangay Bagong Silangan	Bagong Silangan	54,285,074.57	300	Engineering Department	OCM-20% CDF
15	21-00230	Proposed Construction and Installation of Streetlight posts at Barangay Payatas	Payatas	57,409,659.07	300	Engineering Department	OCM-20% CDF

1. The **QUEZON CITY LOCAL GOVERNMENT**, through *funding source of various years* intends to apply the sum stated above being the Approved Budget for the Contract (ABC) to payments under the contract *for the above stated Projects*. Bids received in excess of the ABC shall be automatically rejected at bid opening.
2. The **QUEZON CITY LOCAL GOVERNMENT** now invites bids for the above Procurement Project. Completion of the Works is required *as stated above*. Bidders should have completed a contract similar to the Project. The description of an eligible bidder is contained in the Bidding Documents, particularly, in Section II (Instructions to Bidders).
3. Bidding will be conducted through open competitive bidding procedures using non-discretionary “*pass/fail*” criterion as specified in the 2016 revised Implementing Rules and Regulations (IRR) of Republic Act (RA) No. 9184.
4. Interested bidders may obtain further information from **QUEZON CITY LOCAL GOVERNMENT – BAC Secretariat** and inspect the Bidding Documents at the address given below *weekdays from 8:00 am. – 5:00 p.m.*
5. A complete set of Bidding Documents may be acquired by interested bidders on **6 December 2021 (Monday)** from given address and website/s below *and upon payment of a non-refundable fee for the Bidding Documents, pursuant to the latest Guidelines issued by the GPPB*. The Procuring Entity shall allow the bidder to present its proof of payment for the fees *presented in person*.

**STANDARD RATES:**

Approved Budget for the Contract	Maximum Cost of Bidding Documents (in Philippine Peso)
More than 1 Million up to 5 Million	5,000.00
More than 5 Million up to 10 Million	10,000.00
More than 10 Million up to 50 Million	25,000.00
More than 50 Million up to 500 Million	50,000.00
More than 500 Million	75,000.00

The following are the requirements for purchase of Bidding Documents;

1. PhilGEPS Registration Certificate (Platinum – 3 Pages)
2. Document Request List (DRL)
3. Authorization to purchase bidding documents
  - 3.1 Secretary's Certificate (for corporation)
  - 3.2 Special Power of Attorney (for sole proprietorship)
4. Notarized Joint Venture Agreement (if applicable)
5. Letter of Intent

It must be duly received by the BAC Secretariat at 2<sup>nd</sup> Floor, Procurement Department, Finance Building, Quezon City Hall Compound on or before **December 13, 2021 - 5:00PM.**

6. The **QC- BAC- INFRASTRUCTURE & CONSULTANCY** will hold a Pre-Bid Conference<sup>1</sup> on **December 14, 2021 at 10:00 AM at 2<sup>nd</sup> Floor, Procurement Department-Bidding Room, Finance Building, Quezon City Hall Compound** or we encourage the prospective bidders to join through our **Virtual Conference (ZOOM APP)** which shall be open to prospective bidders.

**Virtual Conference (ZOOM APP)**

**Meeting ID: 854 9489 0133**

**Password: 273320**

7. Bids must be duly received by the BAC Secretariat through manual submission at the office address as indicated below, on or before **December 28, 2021 – 9:00AM.** Late bids shall not be accepted.
8. All bids must be accompanied by a bid security in any of the acceptable forms and in the amount stated in **ITB Clause 16.**
9. Bid opening shall be on **December 28, 2021 - 10:00 AM at 2<sup>nd</sup> Floor, Procurement Department-Bidding Room, Finance Building, Quezon City Hall Compound** and/or via Zoom. Bids will be opened in the presence of the bidders' representatives who choose to attend the activity.

**Virtual Conference (ZOOM APP)**

**Meeting ID: 810 3646 5257**

**Password: 201522**

10. The **Quezon City Local Government** reserves the right to reject any and all bids, declare a failure of bidding, or not award the contract at any time prior to contract award in accordance with Sections 35.6 and 41 of the 2016 revised Implementing Rules and Regulations (IRR) of RA No. 9184, without thereby incurring any liability to the affected bidder or bidders.
11. For further information, please refer to:

**ATTY. DOMINIC B. GARCIA**

OIC, Procurement Department

2<sup>nd</sup> Floor, Procurement Department,

Finance Building, Quezon City Hall Compound

Elliptical Road, Barangay Central Diliman, Quezon City.

Tel. No. (02)8988-4242 loc. 8506/8710

Email Add: [bacinfra.procurement@quezoncity.gov.ph](mailto:bacinfra.procurement@quezoncity.gov.ph)

Website: [www.quezoncity.gov.ph](http://www.quezoncity.gov.ph)

---

<sup>1</sup> May be deleted in case the ABC is less than One Million Pesos (PhP1,000,000) where the Procuring Entity may not hold a pre-bid conference.

12. You may visit the following websites:

For downloading of Bidding Documents: <https://quezoncity.gov.ph/public-notices/procurement/>

By:

  
**ATTY. MARK DALE DIAMOND P. PERRAL**  
Chairman, BAC-Infra and Consultancy 

## ***Section II. Instructions to Bidders***

### **Notes on the Instructions to Bidders**

This Section on the Instruction to Bidders (ITB) provides the information necessary for bidders to prepare responsive bids, in accordance with the requirements of the Procuring Entity. It also provides information on bid submission, eligibility check, opening and evaluation of bids, post-qualification, and on the award of contract.

## 1. Scope of Bid

The Procuring Entity, **Quezon City Government** invites Bids for the **PROPOSED CONSTRUCTION OF REINFORCED CONCRETE RETAINING WALL AT KAINGIN I BUNGAD**, with Project Identification Number **21-00217**.

*[Note: The Project Identification Number is assigned by the Procuring Entity based on its own coding scheme and is not the same as the PhilGEPS reference number, which is generated after the posting of the bid opportunity on the PhilGEPS website.]*

The Procurement Project (referred to herein as “Project”) is for the construction of Works, as described in Section VI (Specifications).

## 2. Funding Information

2.1. The GOP through the source of funding as indicated below for **2021** in the amount of **Four Million Seven Hundred Ninety Thousand Thirty-Two Pesos & 81/100 Cts. (P 4,790,032.81)**.

2.2. The source of funding is:

a. LGUs, the Annual or Supplemental Budget, as approved by the Sanggunian.

## 3. Bidding Requirements

The Bidding for the Project shall be governed by all the provisions of RA No. 9184 and its 2016 revised IRR, including its Generic Procurement Manual and associated policies, rules and regulations as the primary source thereof, while the herein clauses shall serve as the secondary source thereof.

Any amendments made to the IRR and other GPPB issuances shall be applicable only to the ongoing posting, advertisement, or invitation to bid by the BAC through the issuance of a supplemental or bid bulletin.

The Bidder, by the act of submitting its Bid, shall be deemed to have inspected the site, determined the general characteristics of the contracted Works and the conditions for this Project, such as the location and the nature of the work; (b) climatic conditions; (c) transportation facilities; (c) nature and condition of the terrain, geological conditions at the site communication facilities, requirements, location and availability of construction aggregates and other materials, labor, water, electric power and access roads; and (d) other factors that may affect the cost, duration and execution or implementation of the contract, project, or work and examine all instructions, forms, terms, and project requirements in the Bidding Documents.

## 4. Corrupt, Fraudulent, Collusive, Coercive, and Obstructive Practices

The Procuring Entity, as well as the Bidders and Contractors, shall observe the highest standard of ethics during the procurement and execution of the contract. They or through an agent shall not engage in corrupt, fraudulent, collusive, coercive, and

obstructive practices defined under Annex “P” of the 2016 revised IRR of RA No. 9184 or other integrity violations in competing for the Project.

## 5. Eligible Bidders

- 5.1. Only Bids of Bidders found to be legally, technically, and financially capable will be evaluated.
- 5.2. The Bidder must have an experience of having completed a Single Largest Completed Contract (SLCC) that is similar to this Project, equivalent to at least fifty percent (50%) of the ABC adjusted, if necessary, by the Bidder to current prices using the PSA’s CPI, except under conditions provided for in Section 23.4.2.4 of the 2016 revised IRR of RA No. 9184.  
  
A contract is considered to be “similar” to the contract to be bid if it has the major categories of work stated in the **BDS**.
- 5.3. For Foreign-funded Procurement, the Procuring Entity and the foreign government/foreign or international financing institution may agree on another track record requirement, as specified in the Bidding Document prepared for this purpose.
- 5.4. The Bidders shall comply with the eligibility criteria under Section 23.4.2 of the 2016 IRR of RA No. 9184.

## 6. Origin of Associated Goods

There is no restriction on the origin of Goods other than those prohibited by a decision of the UN Security Council taken under Chapter VII of the Charter of the UN.

## 7. Subcontracts

- 7.1. The Bidder may subcontract portions of the Project to the extent allowed by the Procuring Entity as stated herein, but in no case more than fifty percent (50%) of the Project.

The Procuring Entity has prescribed that:

- a. **Subcontracting is not allowed.**

- 7.1. *[If Procuring Entity has determined that subcontracting is allowed during the bidding , state:]* The Bidder must submit together with its Bid the documentary requirements of the subcontractor(s) complying with the eligibility criterial stated in **ITB** Clause 5 in accordance with Section 23.4 of the 2016 revised IRR of RA No. 9184 pursuant to Section 23.1 thereof.
- 7.2. *[If subcontracting is allowed during the contract implementation stage, state:]* The Supplier may identify its subcontractor during the contract implementation stage. Subcontractors identified during the bidding may be changed during the implementation of this Contract. Subcontractors must submit the documentary



requirements under Section 23.1 of the 2016 revised IRR of RA No. 9184 and comply with the eligibility criteria specified in **ITB** Clause 5 to the implementing or end-user unit.

- 7.3. Subcontracting of any portion of the Project does not relieve the Contractor of any liability or obligation under the Contract. The Supplier will be responsible for the acts, defaults, and negligence of any subcontractor, its agents, servants, or workmen as fully as if these were the Contractor's own acts, defaults, or negligence, or those of its agents, servants, or workmen.

## **8. Pre-Bid Conference**

The Procuring Entity will hold a pre-bid conference for this Project on the specified date and time and either at its physical address on **December 14, 2021, 10:00 A.M. at 2nd Floor, Procurement Department-Bidding Room, Finance Building, Quezon City Hall Compound** and/or we encourage the prospective bidders to join through our **Virtual Conference (ZOOM APP) Meeting ID: 854 9489 0133 Password: 273320**

## **9. Clarification and Amendment of Bidding Documents**

Prospective bidders may request for clarification on and/or interpretation of any part of the Bidding Documents. Such requests must be in writing and received by the Procuring Entity, either at its given address or through electronic mail indicated in the **IB**, at least ten (10) calendar days before the deadline set for the submission and receipt of Bids.

## **10. Documents Comprising the Bid: Eligibility and Technical Components**

- 10.1. The first envelope shall contain the eligibility and technical documents of the Bid as specified in **Section IX. Checklist of Technical and Financial Documents**.
- 10.2. If the eligibility requirements or statements, the bids, and all other documents for submission to the BAC are in foreign language other than English, it must be accompanied by a translation in English, which shall be authenticated by the appropriate Philippine foreign service establishment, post, or the equivalent office having jurisdiction over the foreign bidder's affairs in the Philippines. For Contracting Parties to the Apostille Convention, only the translated documents shall be authenticated through an apostille pursuant to GPPB Resolution No. 13-2019 dated 23 May 2019. The English translation shall govern, for purposes of interpretation of the bid.
- 10.3. A valid PCAB License is required, and in case of joint ventures, a valid special PCAB License, and registration for the type and cost of the contract for this Project. Any additional type of Contractor license or permit shall be indicated in the **BDS**.
- 10.4. A List of Contractor's key personnel (e.g., Project Manager, Project Engineers, Materials Engineers, and Foremen) assigned to the contract to be bid, with their

complete qualification and experience data shall be provided. These key personnel must meet the required minimum years of experience set in the **BDS**.

- 10.5. A List of Contractor's major equipment units, which are owned, leased, and/or under purchase agreements, supported by proof of ownership, certification of availability of equipment from the equipment lessor/vendor for the duration of the project, as the case may be, must meet the minimum requirements for the contract set in the **BDS**.

## **11. Documents Comprising the Bid: Financial Component**

- 11.1. The second bid envelope shall contain the financial documents for the Bid as specified in **Section IX. Checklist of Technical and Financial Documents**.
- 11.2. Any bid exceeding the ABC indicated in paragraph 1 of the **IB** shall not be accepted.
- 11.3. For Foreign-funded procurement, a ceiling may be applied to bid prices provided the conditions are met under Section 31.2 of the 2016 revised IRR of RA No. 9184.

## **12. Alternative Bids**

Bidders shall submit offers that comply with the requirements of the Bidding Documents, including the basic technical design as indicated in the drawings and specifications. Unless there is a value engineering clause in the **BDS**, alternative Bids shall not be accepted.

## **13. Bid Prices**

All bid prices for the given scope of work in the Project as awarded shall be considered as fixed prices, and therefore not subject to price escalation during contract implementation, except under extraordinary circumstances as determined by the NEDA and approved by the GPPB pursuant to the revised Guidelines for Contract Price Escalation guidelines.

## **14. Bid and Payment Currencies**

- 14.1. Bid prices may be quoted in the local currency or tradeable currency accepted by the BSP at the discretion of the Bidder. However, for purposes of bid evaluation, Bids denominated in foreign currencies shall be converted to Philippine currency based on the exchange rate as published in the BSP reference rate bulletin on the day of the bid opening.
- 14.2. *Payment of the contract price shall be made in:*
  - a. Philippine Pesos.

## **15. Bid Security**

- 15.1. The Bidder shall submit a Bid Securing Declaration or any form of Bid Security in the amount indicated in the **BDS**, which shall be not less than the percentage of the ABC in accordance with the schedule in the **BDS**.
- 15.2. The Bid and bid security **in no case shall exceed One Hundred Twenty (120) calendar days from the date of opening of bids, unless duly extended by the bidder upon the request of the Head of the Procuring Entity (HoPE) of the Quezon City Local Government**. Any bid not accompanied by an acceptable bid security shall be rejected by the Procuring Entity as non-responsive.

## **16. Sealing and Marking of Bids**

Each Bidder shall submit one copy of the first and second components of its Bid.

The Procuring Entity may request additional hard copies and/or electronic copies of the Bid. However, failure of the Bidders to comply with the said request shall not be a ground for disqualification.

If the Procuring Entity allows the submission of bids through online submission to the given website or any other electronic means, the Bidder shall submit an electronic copy of its Bid, which must be digitally signed. An electronic copy that cannot be opened or is corrupted shall be considered non-responsive and, thus, automatically disqualified.

## **17. Deadline for Submission of Bids**

The Bidders shall submit on the specified date and time and either at its physical address or through online submission as indicated in paragraph 5 of the **IB**.

## **18. Opening and Preliminary Examination of Bids**

- 18.1. The BAC shall open the Bids in public at the time, on the date, and at the place specified in paragraph 9 of the **IB**. The Bidders' representatives who are present shall sign a register evidencing their attendance. In case videoconferencing, webcasting or other similar technologies will be used, attendance of participants shall likewise be recorded by the BAC Secretariat.

In case the Bids cannot be opened as scheduled due to justifiable reasons, the rescheduling requirements under Section 29 of the 2016 revised IRR of RA No. 9184 shall prevail.

- 18.2. The preliminary examination of Bids shall be governed by Section 30 of the 2016 revised IRR of RA No. 9184.

## **19. Detailed Evaluation and Comparison of Bids**

- 19.1. The Procuring Entity's BAC shall immediately conduct a detailed evaluation of all Bids rated "*passed*" using non-discretionary pass/fail criteria. The BAC

shall consider the conditions in the evaluation of Bids under Section 32.2 of 2016 revised IRR of RA No. 9184.

- 19.2. If the Project allows partial bids, all Bids and combinations of Bids as indicated in the **BDS** shall be received by the same deadline and opened and evaluated simultaneously so as to determine the Bid or combination of Bids offering the lowest calculated cost to the Procuring Entity. Bid Security as required by **ITB** Clause 15 shall be submitted for each contract (lot) separately.
- 19.3. In all cases, the NFCC computation pursuant to Section 23.4.2.6 of the 2016 revised IRR of RA No. 9184 must be sufficient for the total of the ABCs for all the lots participated in by the prospective Bidder.

## **20. Post Qualification**

Within a non-extendible period of five (5) calendar days from receipt by the Bidder of the notice from the BAC that it submitted the Lowest Calculated Bid, the Bidder shall submit its latest income and business tax returns filed and paid through the BIR Electronic Filing and Payment System (eFPS), and other appropriate licenses and permits required by law and stated in the **BDS**.

## **21. Signing of the Contract**

The documents required in Section 37.2 of the 2016 revised IRR of RA No. 9184 shall form part of the Contract. Additional Contract documents are indicated in the **BDS**.

## ***Section III. Bid Data Sheet***

### **Notes on the Bid Data Sheet (BDS)**

The Bid Data Sheet (BDS) consists of provisions that supplement, amend, or specify in detail, information, or requirements included in the ITB found in Section II, which are specific to each procurement.

This Section is intended to assist the Procuring Entity in providing the specific information in relation to corresponding clauses in the ITB and has to be prepared for each specific procurement.

The Procuring Entity should specify in the BDS information and requirements specific to the circumstances of the Procuring Entity, the processing of the procurement, and the bid evaluation criteria that will apply to the Bids. In preparing the BDS, the following aspects should be checked:

- a. Information that specifies and complements provisions of the ITB must be incorporated.
- b. Amendments and/or supplements, if any, to provisions of the ITB as necessitated by the circumstances of the specific procurement, must also be incorporated.

# Bid Data Sheet

ITB Clause																																													
5.2	For this purpose, similar contracts shall refer to contracts which have the same major categories of work.																																												
7.1	<b>Subcontracting is not allowed.</b>																																												
10.3	<p><i>No additional contractor license or permit is required</i></p> <p><b><i>In addition, eligible bidders shall qualify or comply with the following:</i></b></p> <p>1. Bidders with valid Philippine Contractors Accreditation Board (PCAB)</p> <p style="padding-left: 40px;">Type</p> <p style="text-align: center;"><b>Flood Control - Small B</b></p>																																												
10.4	<p>The minimum work experience requirements for key personnel are the following:</p> <table border="1" style="width: 100%; border-collapse: collapse;"> <thead> <tr> <th style="text-align: center;">Qty.</th> <th style="text-align: center;">Key Personnel</th> <th style="text-align: center;">General Experience</th> <th style="text-align: center;">Relevant Experience</th> </tr> </thead> <tbody> <tr> <td style="text-align: center;">1</td> <td>Project Manager</td> <td style="text-align: center;">3 years</td> <td style="text-align: center;">3 years</td> </tr> <tr> <td style="text-align: center;">1</td> <td>Project Engineer</td> <td style="text-align: center;">3 years</td> <td style="text-align: center;">3 years</td> </tr> <tr> <td style="text-align: center;">1</td> <td>DPWH duly accredited Materials Engineer</td> <td style="text-align: center;">3 years</td> <td style="text-align: center;">3 years</td> </tr> <tr> <td style="text-align: center;">1</td> <td>Safety Officer</td> <td style="text-align: center;">3 years</td> <td style="text-align: center;">3 years</td> </tr> <tr> <td style="text-align: center;">As needed</td> <td>Surveyor</td> <td style="text-align: center;">3 years</td> <td style="text-align: center;">3 years</td> </tr> <tr> <td style="text-align: center;">As needed</td> <td>Surveyor Assistant</td> <td style="text-align: center;">3 years</td> <td style="text-align: center;">3 years</td> </tr> <tr> <td style="text-align: center;">1</td> <td>Procurement Officer</td> <td style="text-align: center;">3 years</td> <td style="text-align: center;">3 years</td> </tr> <tr> <td style="text-align: center;">7</td> <td>Equipment Operator</td> <td style="text-align: center;">3 years</td> <td style="text-align: center;">3 years</td> </tr> <tr> <td style="text-align: center;">1</td> <td>General Foreman</td> <td style="text-align: center;">3 years</td> <td style="text-align: center;">3 years</td> </tr> <tr> <td style="text-align: center;">6</td> <td>Laborer</td> <td style="text-align: center;">1 year</td> <td style="text-align: center;">3 months</td> </tr> </tbody> </table> <p><b><i>In addition, the bidder must execute an affidavit of undertaking duly notarized stating that the foregoing personnel shall perform work exclusively for the project until its completion. Please see attached bid forms.</i></b></p>	Qty.	Key Personnel	General Experience	Relevant Experience	1	Project Manager	3 years	3 years	1	Project Engineer	3 years	3 years	1	DPWH duly accredited Materials Engineer	3 years	3 years	1	Safety Officer	3 years	3 years	As needed	Surveyor	3 years	3 years	As needed	Surveyor Assistant	3 years	3 years	1	Procurement Officer	3 years	3 years	7	Equipment Operator	3 years	3 years	1	General Foreman	3 years	3 years	6	Laborer	1 year	3 months
Qty.	Key Personnel	General Experience	Relevant Experience																																										
1	Project Manager	3 years	3 years																																										
1	Project Engineer	3 years	3 years																																										
1	DPWH duly accredited Materials Engineer	3 years	3 years																																										
1	Safety Officer	3 years	3 years																																										
As needed	Surveyor	3 years	3 years																																										
As needed	Surveyor Assistant	3 years	3 years																																										
1	Procurement Officer	3 years	3 years																																										
7	Equipment Operator	3 years	3 years																																										
1	General Foreman	3 years	3 years																																										
6	Laborer	1 year	3 months																																										
10.5	The minimum major equipment requirements are the following:																																												

	Equipment	Capacity	Number of Units
	Backhoe with Concrete Breaker		1
	Jackhammer		1
	Dump Truck		1
	Pay Loader		1
	Concrete Vibrator		1
	Concrete Mixer (2-Bagger)		1
	Elf Truck		1
	<i>In addition, the bidder must execute an affidavit of undertaking duly notarized stating that the foregoing equipment shall be used exclusively for the project until its completion. Please see attached bid forms.</i>		
12	[Insert Value Engineering clause if allowed.]		
15.1	<p>The bid security shall be in the form of a Bid Securing Declaration with project number, or any of the following forms and amounts:</p> <p>a) The amount of not less than Php 95,800.66 or equivalent to two percent (2%) of ABC if bid security is in cash, cashier's/manager's check, bank draft/guarantee or irrevocable letter of credit; or</p> <p>b) The amount of not less than Php 239,501.64 or equivalent to five percent (5%) of ABC if bid security is in Surety Bond.</p>		
19.2	<b>Partial bid is not allowed.</b> The infrastructure project is packaged in a single lot and the lot shall not be divided into sub-lots for the purpose of bidding, evaluation, and contract award.		
20	No additional requirement.		
21	<p><b>Additional Contract Documents relevant to the Project as required:</b></p> <ol style="list-style-type: none"> <li><b>1. Construction Schedule and S-curve,</b></li> <li><b>2. Manpower Schedule,</b></li> <li><b>3. Construction Methods,</b></li> <li><b>4. Equipment Utilization Schedule,</b></li> <li><b>5. PERT/CPM or other acceptable tools of project scheduling, shall be included in the submission of Technical Proposal.</b></li> </ol>		

## ***Section IV. General Conditions of Contract***

### **Notes on the General Conditions of Contract**

The General Conditions of Contract (GCC) in this Section, read in conjunction with the Special Conditions of Contract in Section V and other documents listed therein, should be a complete document expressing all the rights and obligations of the parties.

Matters governing performance of the Contractor, payments under the contract, or matters affecting the risks, rights, and obligations of the parties under the contract are included in the GCC and Special Conditions of Contract.

Any complementary information, which may be needed, shall be introduced only through the Special Conditions of Contract.



## 1. **Scope of Contract**

This Contract shall include all such items, although not specifically mentioned, that can be reasonably inferred as being required for its completion as if such items were expressly mentioned herein. All the provisions of RA No. 9184 and its 2016 revised IRR, including the Generic Procurement Manual, and associated issuances, constitute the primary source for the terms and conditions of the Contract, and thus, applicable in contract implementation. Herein clauses shall serve as the secondary source for the terms and conditions of the Contract.

This is without prejudice to Sections 74.1 and 74.2 of the 2016 revised IRR of RA No. 9184 allowing the GPPB to amend the IRR, which shall be applied to all procurement activities, the advertisement, posting, or invitation of which were issued after the effectivity of the said amendment.

## 2. **Sectional Completion of Works**

If sectional completion is specified in the **Special Conditions of Contract (SCC)**, references in the Conditions of Contract to the Works, the Completion Date, and the Intended Completion Date shall apply to any Section of the Works (other than references to the Completion Date and Intended Completion Date for the whole of the Works).

## 3. **Possession of Site**

3.1 The Procuring Entity shall give possession of all or parts of the Site to the Contractor based on the schedule of delivery indicated in the **SCC**, which corresponds to the execution of the Works. If the Contractor suffers delay or incurs cost from failure on the part of the Procuring Entity to give possession in accordance with the terms of this clause, the Procuring Entity's Representative shall give the Contractor a Contract Time Extension and certify such sum as fair to cover the cost incurred, which sum shall be paid by Procuring Entity.

3.2 If possession of a portion is not given by the above date, the Procuring Entity will be deemed to have delayed the start of the relevant activities. The resulting adjustments in contract time to address such delay may be addressed through contract extension provided under Annex "E" of the 2016 revised IRR of RA No. 9184.

## 4. **The Contractor's Obligations**

The Contractor shall employ the key personnel named in the Schedule of Key Personnel indicating their designation, in accordance with **ITB** Clause 10.3 and specified in the **BDS**, to carry out the supervision of the Works.

The Procuring Entity will approve any proposed replacement of key personnel only if their relevant qualifications and abilities are equal to or better than those of the personnel listed in the Schedule.

## 5. **Performance Security**

- 5.1. Within ten (10) calendar days from receipt of the Notice of Award from the Procuring Entity but in no case later than the signing of the contract by both parties, the successful Bidder shall furnish the performance security in any of the forms prescribed in Section 39 of the 2016 revised IRR.
- 5.2. The Contractor, by entering into the Contract with the Procuring Entity, acknowledges the right of the Procuring Entity to institute action pursuant to RA No. 3688 against any subcontractor be they an individual, firm, partnership, corporation, or association supplying the Contractor with labor, materials and/or equipment for the performance of this Contract.

## **6. Site Investigation Reports**

The Contractor, in preparing the Bid, shall rely on any Site Investigation Reports referred to in the SCC supplemented by any information obtained by the Contractor.

## **7. Warranty**

- 7.1. In case the Contractor fails to undertake the repair works under Section 62.2.2 of the 2016 revised IRR, the Procuring Entity shall forfeit its performance security, subject its property(ies) to attachment or garnishment proceedings, and perpetually disqualify it from participating in any public bidding. All payables of the GOP in his favor shall be offset to recover the costs.
- 7.2. The warranty against Structural Defects/Failures, except that occasioned-on force majeure, shall cover the period from the date of issuance of the Certificate of Final Acceptance by the Procuring Entity. Specific duration of the warranty is found in the SCC.

## **8. Liability of the Contractor**

Subject to additional provisions, if any, set forth in the SCC, the Contractor's liability under this Contract shall be as provided by the laws of the Republic of the Philippines.

If the Contractor is a joint venture, all partners to the joint venture shall be jointly and severally liable to the Procuring Entity.

## **9. Termination for Other Causes**

Contract termination shall be initiated in case it is determined *prima facie* by the Procuring Entity that the Contractor has engaged, before, or during the implementation of the contract, in unlawful deeds and behaviors relative to contract acquisition and implementation, such as, but not limited to corrupt, fraudulent, collusive, coercive, and obstructive practices as stated in ITB Clause 4.

## **10. Dayworks**

Subject to the guidelines on Variation Order in Annex “E” of the 2016 revised IRR of RA No. 9184, and if applicable as indicated in the **SCC**, the Dayworks rates in the Contractor’s Bid shall be used for small additional amounts of work only when the Procuring Entity’s Representative has given written instructions in advance for additional work to be paid for in that way.

## **11. Program of Work**

11.1. The Contractor shall submit to the Procuring Entity’s Representative for approval the said Program of Work showing the general methods, arrangements, order, and timing for all the activities in the Works. The submissions of the Program of Work are indicated in the **SCC**.

11.2. The Contractor shall submit to the Procuring Entity’s Representative for approval an updated Program of Work at intervals no longer than the period stated in the **SCC**. If the Contractor does not submit an updated Program of Work within this period, the Procuring Entity’s Representative may withhold the amount stated in the **SCC** from the next payment certificate and continue to withhold this amount until the next payment after the date on which the overdue Program of Work has been submitted.

## **12. Instructions, Inspections and Audits**

The Contractor shall permit the GOP or the Procuring Entity to inspect the Contractor’s accounts and records relating to the performance of the Contractor and to have them audited by auditors of the GOP or the Procuring Entity, as may be required.

## **13. Advance Payment**

The Procuring Entity shall, upon a written request of the Contractor which shall be submitted as a Contract document, make an advance payment to the Contractor in an amount not exceeding fifteen percent (15%) of the total contract price, to be made in lump sum, or at the most two installments according to a schedule specified in the **SCC**, subject to the requirements in Annex “E” of the 2016 revised IRR of RA No. 9184.

## **14. Progress Payments**

The Contractor may submit a request for payment for Work accomplished. Such requests for payment shall be verified and certified by the Procuring Entity’s Representative/Project Engineer. Except as otherwise stipulated in the **SCC**, materials and equipment delivered on the site but not completely put in place shall not be included for payment.

## **15. Operating and Maintenance Manuals**

15.1. If required, the Contractor will provide “as built” Drawings and/or operating and maintenance manuals as specified in the **SCC**.

- 15.2. If the Contractor does not provide the Drawings and/or manuals by the dates stated above, or they do not receive the Procuring Entity's Representative's approval, the Procuring Entity's Representative may withhold the amount stated in the **SCC** from payments due to the Contractor.

## ***Section V. Special Conditions of Contract***

### **Notes on the Special Conditions of Contract**

Similar to the BDS, the clauses in this Section are intended to assist the Procuring Entity in providing contract-specific information in relation to corresponding clauses in the GCC found in Section IV.

The Special Conditions of Contract (SCC) complement the GCC, specifying contractual requirements linked to the special circumstances of the Procuring Entity, the Procuring Entity's country, the sector, and the Works procured. In preparing this Section, the following aspects should be checked:

- a. Information that complements provisions of the GCC must be incorporated.
- b. Amendments and/or supplements to provisions of the GCC as necessitated by the circumstances of the specific purchase, must also be incorporated.

However, no special condition which defeats or negates the general intent and purpose of the provisions of the GCC should be incorporated herein.

# Special Conditions of Contract

GCC Clause	
2	Completion of work shall be within 120 calendar days.
4.1	The Procuring Entity shall give possession of all parts of the Site to the Contractor upon receipt of the Notice to Proceed.
6	The site investigation reports are: <i>[list here the required site investigation reports.]</i>
7.2	<p><i>[Select one, delete the other.]</i></p> <p><i>[In case of permanent structures, such as buildings of types 4 and 5 as classified under the National Building Code of the Philippines and other structures made of steel, iron, or concrete which comply with relevant structural codes (e.g., DPWH Standard Specifications), such as, but not limited to, steel/concrete bridges, flyovers, aircraft movement areas, ports, dams, tunnels, filtration and treatment plants, sewerage systems, power plants, transmission and communication towers, railway system, and other similar permanent structures:]</i> Fifteen (15) years.</p> <p><i>[In case of semi-permanent structures, such as buildings of types 1, 2, and 3 as classified under the National Building Code of the Philippines, concrete/asphalt roads, concrete river control, drainage, irrigation lined canals, river landing, deep wells, rock causeway, pedestrian overpass, and other similar semi-permanent structures:]</i> Five (5) years.</p> <p><i>[In case of other structures, such as bailey and wooden bridges, shallow wells, spring developments, and other similar structures:]</i> Two (2) years.</p>
10	Dayworks are applicable at the rate shown in the Contractor’s original Bid.
13	The amount of the advance payment is no more that fifteen percent (15%) of the Contract Price subject to approval by the HOPE and compliance with the conditions under RA 9184 and its IRR.
14	No further instructions.
15.1	<p>The date by which operating and maintenance manuals are required is <i>thirty (30) days</i></p> <p>The date by which “as built” drawings are required as part of final payment</p>
15.2	The amount to be withheld for failing to produce “as built” drawings and/or operating and maintenance manuals by the date required is ten (10%) percent of the contract price.

## *Section VI. Specifications*

### **Notes on Specifications**

A set of precise and clear specifications is a prerequisite for Bidders to respond realistically and competitively to the requirements of the Procuring Entity without qualifying or conditioning their Bids. In the context of international competitive bidding, the specifications must be drafted to permit the widest possible competition and, at the same time, present a clear statement of the required standards of workmanship, materials, and performance of the goods and services to be procured. Only if this is done will the objectives of economy, efficiency, and fairness in procurement be realized, responsiveness of Bids be ensured, and the subsequent task of bid evaluation facilitated. The specifications should require that all goods and materials to be incorporated in the Works be new, unused, of the most recent or current models, and incorporate all recent improvements in design and materials unless provided otherwise in the Contract.

Samples of specifications from previous similar projects are useful in this respect. The use of metric units is mandatory. Most specifications are normally written specially by the Procuring Entity or its representative to suit the Works at hand. There is no standard set of Specifications for universal application in all sectors in all regions, but there are established principles and practices, which are reflected in these PBDs.

There are considerable advantages in standardizing General Specifications for repetitive Works in recognized public sectors, such as highways, ports, railways, urban housing, irrigation, and water supply, in the same country or region where similar conditions prevail. The General Specifications should cover all classes of workmanship, materials, and equipment commonly involved in construction, although not necessarily to be used in a particular Works Contract. Deletions or addenda should then adapt the General Specifications to the particular Works.

Care must be taken in drafting specifications to ensure that they are not restrictive. In the specification of standards for goods, materials, and workmanship, recognized international standards should be used as much as possible. Where other particular standards are used, whether national standards or other standards, the specifications should state that goods, materials, and workmanship that meet other authoritative standards, and which ensure substantially equal or higher quality than the standards mentioned, will also be acceptable. The following clause may be inserted in the SCC.

#### **Sample Clause: Equivalency of Standards and Codes**

Wherever reference is made in the Contract to specific standards and codes to be met by the goods and materials to be furnished, and work performed or tested, the provisions of the latest current edition or revision of the relevant standards and codes in effect shall apply, unless otherwise expressly stated in the Contract. Where such standards and codes are national, or relate to a particular country or region, other authoritative standards that ensure a substantially equal or higher quality than the standards and codes specified will be accepted

subject to the Procuring Entity's Representative's prior review and written consent. Differences between the standards specified and the proposed alternative standards shall be fully described in writing by the Contractor and submitted to the Procuring Entity's Representative at least twenty-eight (28) days prior to the date when the Contractor desires the Procuring Entity's Representative's consent. In the event the Procuring Entity's Representative determines that such proposed deviations do not ensure substantially equal or higher quality, the Contractor shall comply with the standards specified in the documents.

These notes are intended only as information for the Procuring Entity or the person drafting the Bidding Documents. They should not be included in the final Bidding Documents.





REPLUBLIKA NG PILIPINAS  
LUNGSOD QUEZON  
**CITY ENGINEERING DEPARTMENT**  
5<sup>TH</sup> 6<sup>TH</sup> 7<sup>TH</sup> Floors, QC Civic Center Building "B"  
Telephone Nos. 8988-4242 Local 8538



NAME OF PROJECT : **PROPOSED CONSTRUCTION OF REINFORCED CONCRETE  
RETAINING WALL AT KAINGIN I BUNGAD** ✓

LOCATION : **BARANGAY PANSOL, DISTRICT 3, QUEZON CITY** ✓

## TECHNICAL SPECIFICATIONS

### I. GENERAL REQUIREMENTS

#### ITEM SPL 7 – BILLBOARD DESCRIPTION

This item shall consist of installation of Billboards on locations as established by the Engineer-In-Charge in conformity with the standard size, design, layout and dimension as shown in the Plans.

#### MATERIAL REQUIREMENTS

Based on the standard design approved by and material requirement of the implementing agency.

#### ITEM SPL 12 CONSTRUCTION SAFETY AND HEALTH DESCRIPTION

This item shall include necessary provision of construction safety and health gear such as safety vest, Safety helmet, First Aid Kit, Safety Boots and Gloves. All materials delivered and utilized for the project shall be turned-over to the Implementing agency after the completion of the project.

#### MATERIAL REQUIREMENTS

Based on the standard design and specifications approved by and material requirement of the implementing agency.

#### ITEM SPL 13 STEEL BARRICADE (RENTAL) DESCRIPTION

This item shall consist of fabrication of steel barricades in accordance with the Standard Specifications for Public Works and Highways and in reasonably close conformity shown on the plans or as established by the Engineer-In-Charge.

#### MATERIAL REQUIREMENTS

##### *STEEL BARRICADES*

Metal units shall conform to the plan dimensions and to the following specification requirements for the designated materials. Metal gratings and covers which are to rest on frames shall bear on them evenly.

They shall be assembled before shipment and so marked that the same pieces may be reassembled readily in the same position when installed. Inaccuracy of bearings shall be corrected by machining, if necessary. A frame and a grating or cover to be used with it shall constitute one pair.

All castings shall be uniformly coated with asphalt-based emulsion meeting the requirements of ASTM D 1187, Asphalt-base Emulsion for use as Protective Coating for Metal. Samples of the material in casting shall be taken during the casting of the units and shall be separate casting poured from the same material as the casting they represent.

Structural steel	AASHTO M 183
Galvanizing, where specified for these units, shall conform to the requirements of	AASHTO M 111
Reinforcing Steel	AASHTO M 31

## **ITEM SPL42 – HAULING OF CONSTRUCTION MATERIALS**

### **DESCRIPTION**

This item shall consist of the transport and delivery of all materials necessary in the implementation of all scope of works covered by the contract.

## **II. SITE WORKS**

### **ITEM 106c – EXCAVATION (SOLID ROCK ADOBE)**

#### **DESCRIPTION**

This item shall consist of the necessary excavation for reinforced concrete pipes, lined canal, box culverts and other structures not otherwise provided for in the Specifications. Except as otherwise provided for pipe culverts, the backfilling of completed structures and the disposal of all excavated materials shall be in accordance with this specification and in reasonably close conformity with the Plans or as established by the Engineer-In-Charge. This Item shall include necessary diverting of live streams, bailing, pumping, draining, sheeting, bracing, and the necessary construction of cribs and cofferdams, and furnishing the materials therefore, and the subsequent removal of cribs and cofferdams and the placing of all necessary backfill. It shall also include the furnishing and placing of approved foundation fill material to replace unsuitable material encountered below the foundation elevation of structures.

### **ITEM SPL 33– SHORING**

#### **DESCRIPTION**

This item shall consist of installation of shoring and barricade to prevent soil erosion on the location and in conformity with the lines, grades, dimensions and design shown on the Plans or as required by the Engineer-In-Charge.

#### **MATERIAL REQUIREMENTS**

Based on the standard design approved by and material requirement of the implementing agency.

## **III. CIVIL / STRUCTURAL WORKS**

### **ITEM SPL 55f– REINFORCED CONCRETE RETAINING WALL**

#### **DESCRIPTION**

This item shall consist of furnishing, placing and finishing concrete and reinforcing bars in all structures of the concrete barricade in conformity to the lines, grades, and dimensions shown on the Plans. Compressive strength of concrete shall be 4000 psi and reinforcing steel bars shall not be less than Grade 60.

#### **MATERIAL REQUIREMENTS**

##### *PORTLAND CEMENT*

It shall conform to the applicable requirements AASHTO M 85, Hydraulic Cement. Only Type I Portland Cement shall be used unless otherwise provided for in the Special Provisions. Different brands or the same brands from different mills shall not be mixed nor shall they be used alternately unless the mix is

approved by the Engineer. However, the use of Portland Pozzolana Cement Type IP meeting the requirements of AASHTO M 240/ASTM C 695, Specifications for Blended Hydraulic Cement shall be allowed, provided that trial mixes shall be done and that the mixes meet the concrete strength requirements, the AASHTO/ASTM provisions pertinent to the use of Portland Pozzolana Type IP shall be adopted. Cement which for any reason, has become partially set or which contains lumps of caked cement shall be rejected. Samples of cement shall be obtained in accordance with AASHTO T 127.

#### *FINE AGGREGATES*

It shall consist of natural sand, stone screenings or other inert materials with similar characteristics, or combinations thereof, having hard, strong and durable particles. Fine aggregate from different sources of supply shall not be mixed or stored in the same pile nor used alternately in the same class of concrete without the approval of the Engineer.

It shall not contain more than three (3) mass percent of material passing the 0.075 mm (No. 200 sieve) by washing nor more than one (1) mass percent each of clay lumps or shale. The use of beach sand will not be allowed without the approval of the Engineer.

If the fine aggregate is subjected to five (5) cycles of the sodium sulfate soundness test, the weighted loss shall not exceed 10 mass percent.

The fine aggregate shall be free from injurious amounts of organic impurities. If subjected to the colorimetric test for organic impurities and a color darker than the standard is produced, it shall be rejected. However, when tested for the effect of organic impurities of strength of mortar by AASHTO T 71, the fine aggregate may be used if the relative strength at 7 and 28 days is not less than 95 mass percent.

The fine aggregate shall be well-graded from coarse to fine and shall conform to Table 311.1

Table 311.1 – Grading Requirements for Fine Aggregate

Sieve Designation	Mass Percent Passing
9.5 mm (3/8 in.)	100
4.75 mm (No. 4)	95 – 100
2.36 mm (No. 8)	-
1.18 mm (No. 16)	45 – 80
0.600 mm (No. 30)	-
0.300 mm (No. 50)	5 – 30
0.150 mm (No. 100)	10

#### *COARSE AGGREGATES*

It shall consist of crushed stone, gravel, blast furnace slag, or other approved inert materials of similar characteristics, or combinations thereof, having hard, strong, durable pieces and free from any adherent coatings.

It shall contain not more than one (1) mass percent of material passing the 0.075 mm (No. 200) sieve, not more than 0.25 mass percent of clay lumps, nor more than 3.5 mass percent of soft fragments.

If the coarse aggregate is subjected to five (5) cycles of the sodium sulfate soundness test, the weighted loss shall not exceed 12 mass percent.

It shall have a mass percent of wear not exceeding 40 when tested by AASHTO T 96.

If the slag is used, its density shall not be less than 1120 kg/m<sup>3</sup> (70 lb./cu. ft.). The gradation of the coarse aggregate shall conform to Table 311.2.

Only one grading specification shall be used from any one source.

Table 311.2 – Grading Requirements for Coarse Aggregate

Sieve Designation		Mass Percent Passing		
Standard (mm)	Alternate U.S. Standard	Grading A	Grading B	Grading C
75	3 in.	100	-	-
63	2 – ½ in.	90 – 100	100	100
50	2 in.	- 90 – 100	95 – 100 37.5	1 – ½ in.

	25 – 60	35 – 70	-	
25	1 in.	- 0 – 15	35 – 70 19.0	¼ in.
	0 – 10	- -		
12.5	½ in.	0 – 5	0-5	10 – 30
4.75	No. 4	-	-	0 – 5

**WATER**

Water used in mixing, curing or other designated application shall be reasonably clean and free of oil, salt, acid, alkali, grass or other substances injurious to the finished product. Water will be tested in accordance with and shall meet the requirements of Item 714, Water. Water which is drinkable may be used without test. Where the source of water is shallow, the intake shall be so enclosed as to exclude silt, mud, grass or other foreign materials.

**REINFORCING STEEL**

It shall conform to the requirements of AASHTO M 225, Reinforcing Steel. Dowels and tie bars shall conform to the requirements of AASHTO M 31 or M 42, except that rail steel shall not be used for tie bars that are to be bent and straightened during construction. Tie bars shall be deformed bars. Dowels shall be plain round bars. Before delivery to the site of work, one-half of the length of each dowel shall be painted with one coat of approved lead or tar paint. The sleeves for dowel bars shall be metal of approved design to cover 50 mm (2 inches), plus or minus 5 mm (1/4 inch) of the dowel, with a closed end, and with a suitable stop to hold the end of the sleeve at least 25 mm (1 inch) from the end of the dowel. Sleeves shall be of such design that they do not collapse during construction.

**ADMIXTURES**

Air-entraining admixture shall conform to the requirements of AASHTO M 154. Chemical admixtures, if specified or permitted, shall conform to the requirements of AASHTO M 194. Fly Ash, if specified or permitted as a mineral admixture and as 20% partial replacement of Portland Cement in concrete mix shall conform to the requirements of ASTM C 618. Admixture should be added only to the concrete mix to produce some desired modifications to the properties of concrete where necessary, but not as partial replacement of cement. If specified, monofilament polypropylene synthetic fibrin fibers, which are used as admixture to prevent the formation of temperature/shrinkage cracks and increase impact resistance of concrete slabs shall be applied in the dosage rate recommended by its manufacturer.

**STORAGE OF CEMENT AND AGGREGATE**

All cement shall be stored, immediately upon delivery at the Site, in weatherproof building which will protect the cement from dampness. The floor shall be raised from the ground. The buildings shall be placed in locations approved by the Engineer. Provisions for storage shall be ample, and the shipments of cement as received shall be separately stored in such a manner as to allow the earliest deliveries to be used first and to provide easy access for identification and inspection of each shipment. Storage buildings shall have capacity for storage of a sufficient quantity of cement to allow sampling at least twelve (12) days before the cement is to be used. Bulk cement, if used, shall be transferred to elevated air tight and weatherproof bins. Stored cement shall meet the test requirements at any time after storage when retest is ordered by the Engineer-in-charge. At the time of use, all cement shall be free-flowing and free of lumps. The handling and storing of concrete aggregates shall be such as to prevent segregation or the inclusion of foreign materials. The Engineer may require that aggregates be stored on separate platforms at satisfactory locations. In order to secure greater uniformity of concrete mix, the Engineer may require that the coarse aggregate be separated into two or more sizes. Different sizes of aggregate shall be stored in separate bins or in separate stockpiles sufficiently removed from each other to prevent the material at the edges of the piles from becoming intermixed.

**FORM LUMBER**

It shall be specified on the plans. It shall be free from loose knots, splits, worn holes, decay, warp, ring separation, or any defects which will impair its strength or render it unfit for its intended use.

**NOTES:**

All other item of works not covered by this listed TECHNICAL SPECIFICATIONS shall be ISSUED with supplemental specifications by the Implementing Agency based on the Program of Work and Approved Plan(s) for the proposed project.

PREPARED BY:

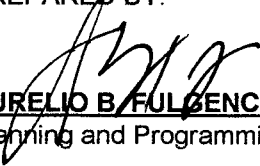
  
**AURELIO B. FULGENCIO**  
Planning and Programming Division

CHECKED BY:

  
**MARILEN F. COMENDADOR**  
Planning and Programming Division

## ***Section VII. Drawings***

*[Insert here a list of Drawings. The actual Drawings, including site plans, should be attached to this section, or annexed in a separate folder.]*

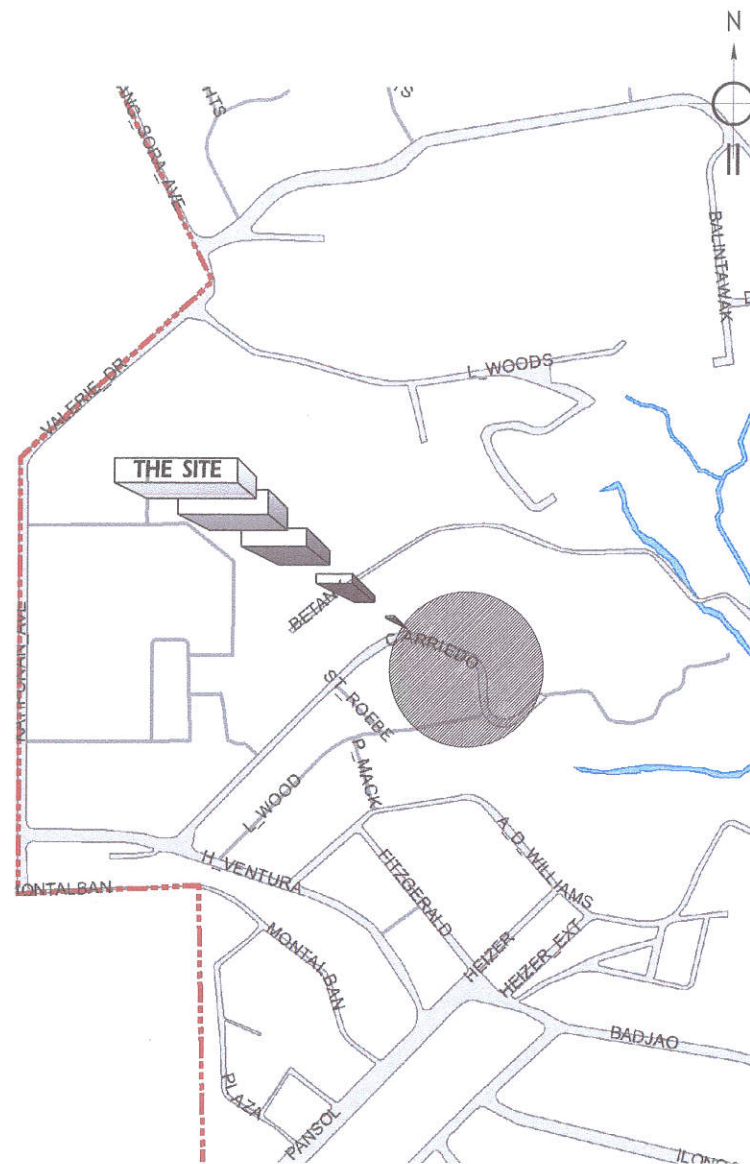
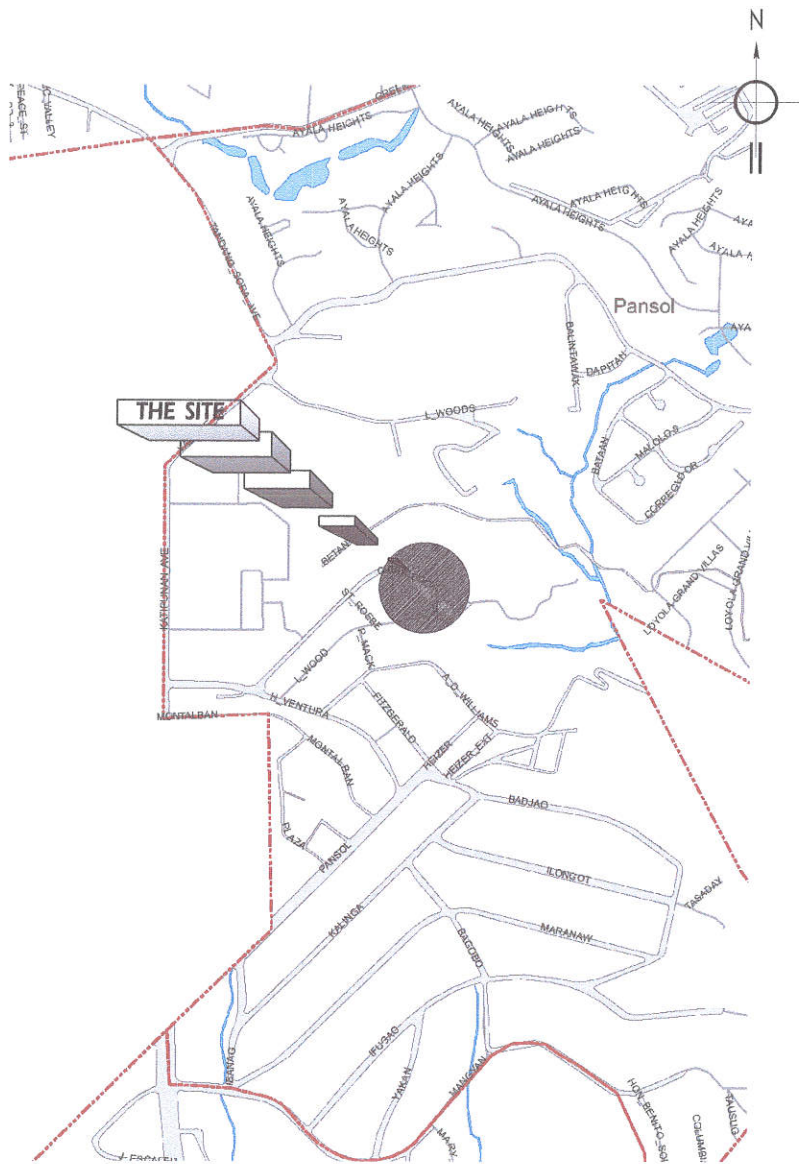

TABLE OF CONTENT	
CW-01	VICINITY MAP LOCATION MAP
CW-02	PLAN
CW-03	SECTION A
CW-04	SHORING DETAIL STEEL BARRICADE DETAIL

**1 VICINITY MAP** SCALE : NTS

**2 LOCATION MAP** SCALE : NTS

Republika ng Pilipinas  
Lungsod ng Quezon  
**CITY ENGINEERING DEPARTMENT**

PROJECT TITLE :  
**PROPOSED CONSTRUCTION OF  
REINFORCED CONCRETE RETAINING  
WALL AT KAINGIN I BUNGAD**

LOCATION :  
BARANGAY PANSOL, DISTRICT 3, QUEZON CITY

DRAWN BY : JFCG  
DATE : 10.29.2021  
CHECKED BY : MFC  
REVISION NO. :

SUBMITTED BY:  
  
**ENGR. LEO S. DEL ROSARIO**  
HEAD, PLANNING & PROGRAMMING DIVISION

RECOMMENDING APPROVAL:  
  
**ENGR. ISAGANI R. VERZOSA, JR.**  
OIC, CITY ENGINEERING DEPARTMENT

APPROVED BY:  
  
**HON. MA. JOSEFINA G. BELMONTE**  
CITY MAYOR, QUEZON CITY

SHEET CONTENT  
VICINITY MAP  
LOCATION MAP

SHEET NO.  
  
14

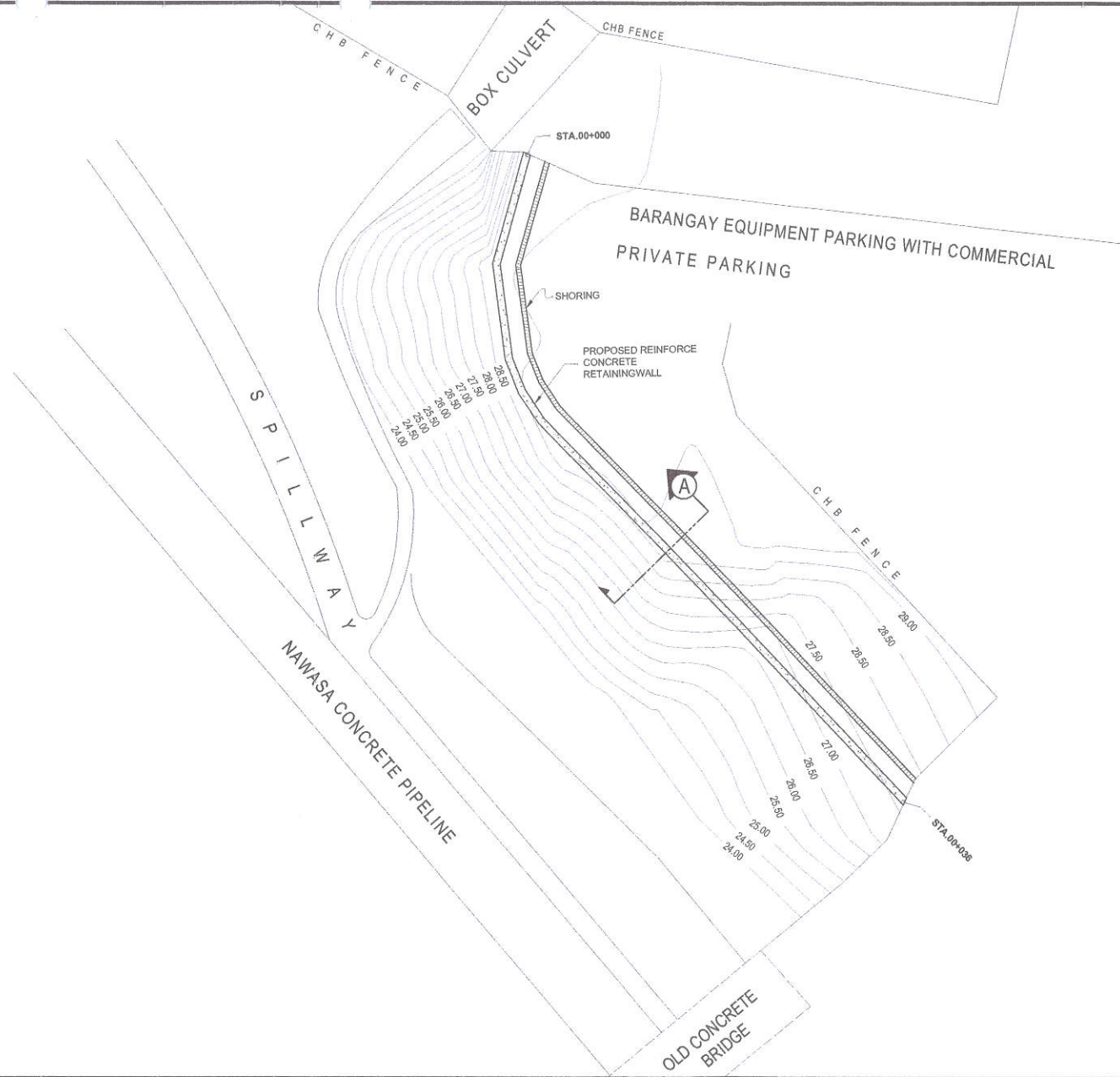

1 | PLAN

SCALE: NTS



Republika ng Pilipinas  
Lungsod ng Quezon  
**CITY ENGINEERING DEPARTMENT**

PROJECT TITLE:  
**PROPOSED CONSTRUCTION OF  
REINFORCED CONCRETE RETAINING  
WALL AT KAINGIN I BUNGAD**  
LOCATION:  
BARANGAY PANSOL, DISTRICT 3, QUEZON CITY

DRAWN BY: JPCG  
DATE: 10.29.2021  
CHECKED BY: MFC  
REVISION NO.:

SUBMITTED BY:  
  
**ENGR. LEO S. DEL ROSARIO**  
HEAD, PLANNING & PROGRAMMING DIVISION

RECOMMENDING APPROVAL:  
  
**ENGR. ISAGANI R. VERZOSA, JR.**  
OIC, CITY ENGINEERING DEPARTMENT

APPROVED BY:  
  
**HON. MA. JOSEFINA G. BELMONTE**  
CITY MAYOR, QUEZON CITY

SHEET CONTENT  
PLAN

SHEET NO.  
  
24



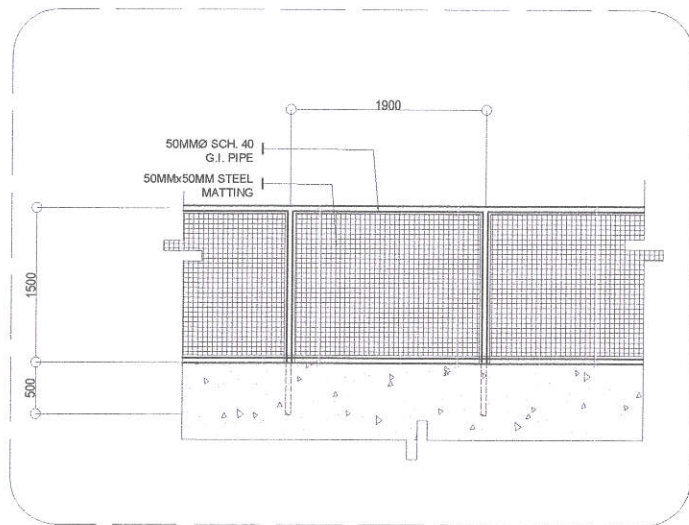

STEEL FENCE DETAIL

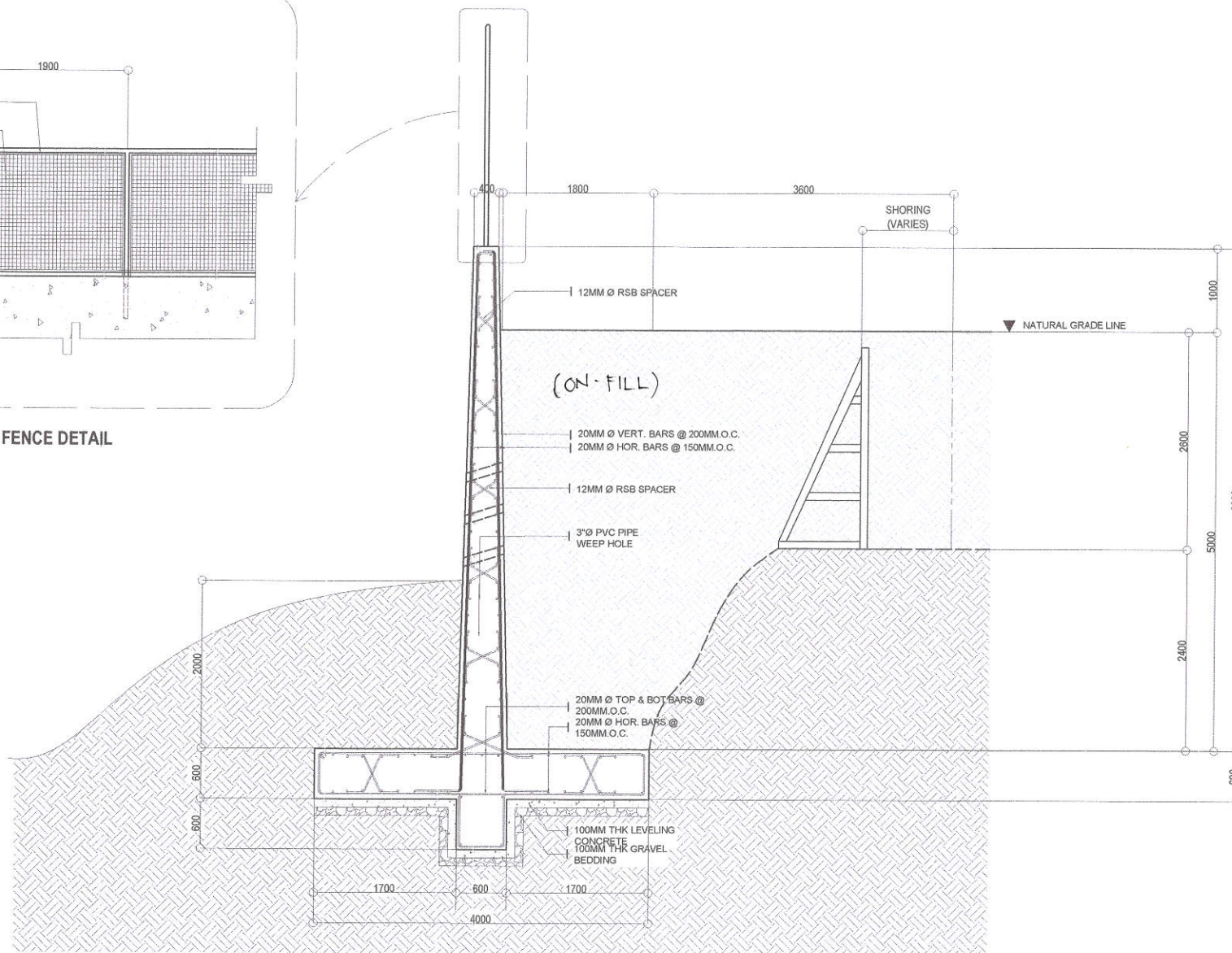

RETAINING WALL DETAIL

1 SECTION A

SCALE: NTS



Republika ng Pilipinas  
Lungsod ng Quezon  
CITY ENGINEERING DEPARTMENT

PROJECT TITLE:  
**PROPOSED CONSTRUCTION OF  
REINFORCED CONCRETE RETAINING  
WALL AT KAINGIN I BUNGAD**  
LOCATION:  
BARANGAY PANSOL, DISTRICT 3, QUEZON CITY

DRAWN BY: JPCG  
DATE: 10.29.2021  
CHECKED BY: MFC  
REVISION NO.:

SUBMITTED BY:  
  
**ENGR. LEO S. DEL ROSARIO**  
HEAD, PLANNING & PROGRAMMING DIVISION

RECOMMENDING APPROVAL:  
  
**ENGR. ISAGAN R. VERZOSA, JR.**  
OIC, CITY ENGINEERING DEPARTMENT

APPROVED BY:  
  
**HON. MA. JOSEFINA G. BELMONTE**  
CITY MAYOR, QUEZON CITY

SHEET CONTENT  
SECTION A

SHEET NO.  
  
3/4

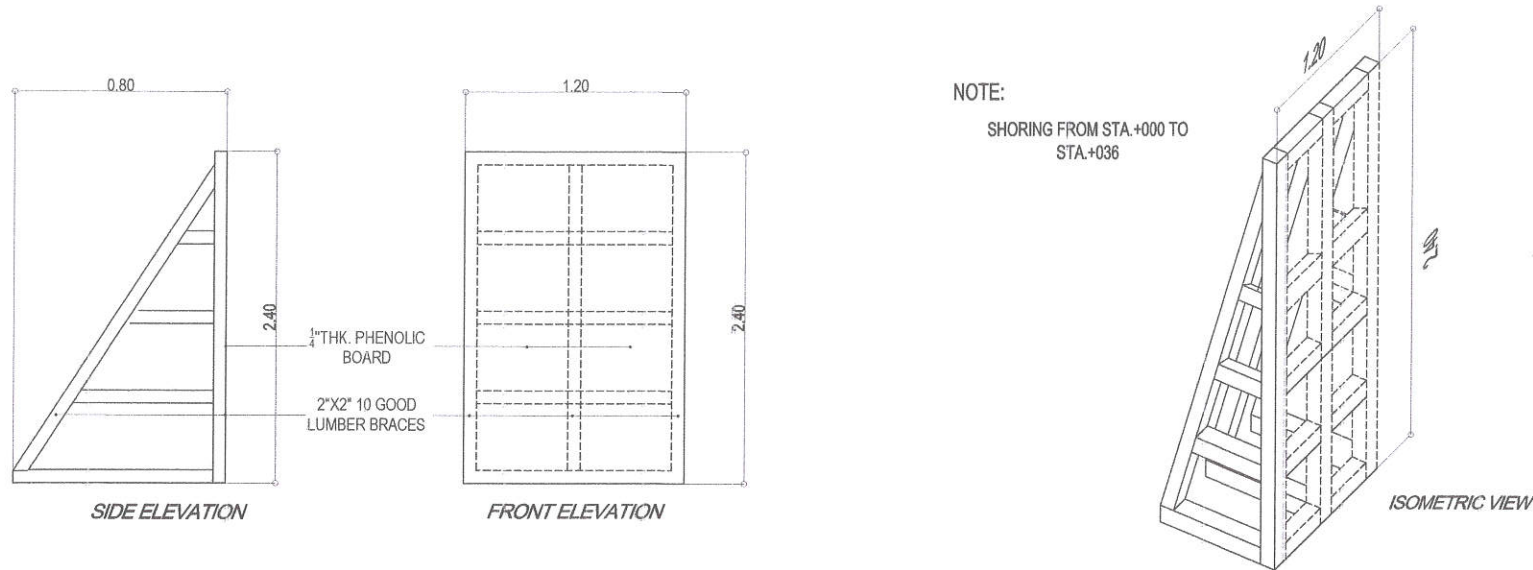

**1 SHORING DETAIL**

SCALE: NTS

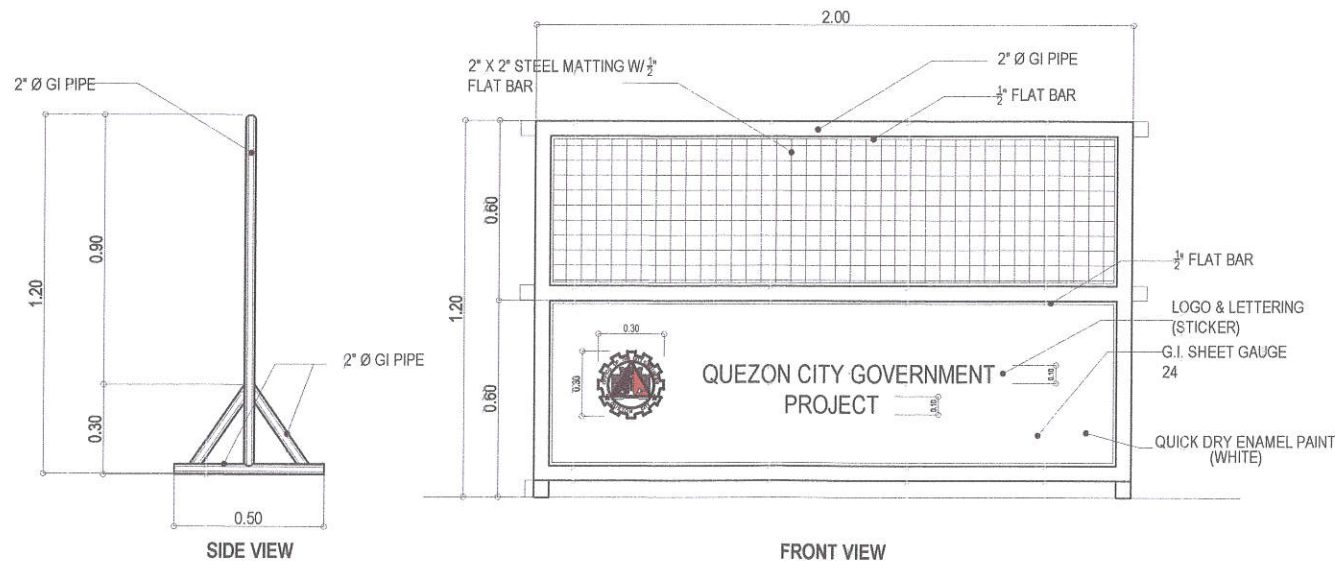

**2 STEEL BARRICADE DETAIL**

SCALE: NTS



Republika ng Pilipinas  
Lungsod ng Quezon  
**CITY ENGINEERING DEPARTMENT**

PROJECT TITLE:	DRAWN BY: JPCG	SUBMITTED BY:	RECOMMENDING APPROVAL:	APPROVED BY:	SHEET CONTENT	SHEET NO.
<b>PROPOSED CONSTRUCTION OF REINFORCED CONCRETE RETAINING WALL AT KAINGIN I BUNGAD</b>	DATE: 10.29.2021				STEEL BARRICADE DETAIL SHORING DETAIL	
	CHECKED BY: MFC					
LOCATION: BARANGAY PANSOL, DISTRICT 3, QUEZON CITY	REVISION NO.:					

## ***Section VIII. Bill of Quantities***

### **Notes on the Bill of Quantities**

#### **Objectives**

The objectives of the Bill of Quantities are:

- a. to provide sufficient information on the quantities of Works to be performed to enable Bids to be prepared efficiently and accurately; and
- b. when a Contract has been entered into, to provide a priced Bill of Quantities for use in the periodic valuation of Works executed.

In order to attain these objectives, Works should be itemized in the Bill of Quantities in sufficient detail to distinguish between the different classes of Works, or between Works of the same nature carried out in different locations or in other circumstances which may give rise to different considerations of cost. Consistent with these requirements, the layout and content of the Bill of Quantities should be as simple and brief as possible.

#### **Daywork Schedule**

A Daywork Schedule should be included only if the probability of unforeseen work, outside the items included in the Bill of Quantities, is high. To facilitate checking by the Entity of the realism of rates quoted by the Bidders, the Daywork Schedule should normally comprise the following:

- a. A list of the various classes of labor, materials, and Constructional Plant for which basic daywork rates or prices are to be inserted by the Bidder, together with a statement of the conditions under which the Contractor will be paid for work executed on a daywork basis.
- b. Nominal quantities for each item of Daywork, to be priced by each Bidder at Daywork rates as Bid. The rate to be entered by the Bidder against each basic Daywork item should include the Contractor's profit, overheads, supervision, and other charges.

#### **Provisional Sums**

A general provision for physical contingencies (quantity overruns) may be made by including a provisional sum in the Summary Bill of Quantities. Similarly, a contingency allowance for possible price increases should be provided as a provisional sum in the Summary Bill of Quantities. The inclusion of such provisional sums often facilitates budgetary approval by avoiding the need to request periodic supplementary approvals as the future need arises. Where such provisional sums or contingency allowances are used, the SCC should state the manner in which they will be used, and under whose authority (usually the Procuring Entity's Representative's).

The estimated cost of specialized work to be carried out, or of special goods to be supplied, by other contractors should be indicated in the relevant part of the Bill of Quantities as a particular provisional sum with an appropriate brief description. A separate procurement procedure is normally carried out by the Procuring Entity to select such specialized contractors. To provide an element of competition among the Bidders in respect of any facilities, amenities, attendance, etc., to be provided by the successful Bidder as prime Contractor for the use and convenience of the specialist contractors, each related provisional sum should be followed by an item in the Bill of Quantities inviting the Bidder to quote a sum for such amenities, facilities, attendance, etc.

### **Signature Box**

A signature box shall be added at the bottom of each page of the Bill of Quantities where the authorized representative of the Bidder shall affix his signature. Failure of the authorized representative to sign each and every page of the Bill of Quantities shall be a cause for rejection of his bid.

These Notes for Preparing a Bill of Quantities are intended only as information for the Procuring Entity or the person drafting the Bidding Documents. They should not be included in the final documents.

**PROJECT TITLE** : PROPOSED CONSTRUCTION OF REINFORCED CONCRETE  
**RETAINING WALL AT KAINGIN I BUNGAD**

**LOCATION** : Barangay Pansol, District 3, Quezon City

**PROJECT NO.** : 21 - 00217

**DURATION** : One Hundred Twenty (120) Calendar Days

***BREAKDOWN OF COST***

ITEM NO.	WORK DESCRIPTION AND SCOPE OF WORKS	DIRECT COST	INDIRECT COST	AMOUNT
I	GENERAL REQUIREMENTS	P	P	P
II	SITE WORKS			
III	CIVIL / STRUCTURAL WORKS			

**TOTAL COST P** \_\_\_\_\_

LUMP SUM BID IN WORDS : \_\_\_\_\_  
 \_\_\_\_\_

Contractor : \_\_\_\_\_

**BILL OF QUANTITIES**  
(Flood Control Construction/Rehabilitation Project)

**PROJECT TITLE** : PROPOSED CONSTRUCTION OF REINFORCED CONCRETE  
RETAINING WALL AT KAINGIN I BUNGAD

**LOCATION** : Barangay Pansol, District 3, Quezon City

**PROJECT NO.** : 21 - 00217

**DURATION** : One Hundred Twenty (120) Calendar Days

Creek Details:

NAME	TYPE	LENGTH	HEIGHT (RCRW)	LIMIT
KAINGIN I BUNGAD	RETAINING WALL	36 M	6 M	Sta. 00+000 to Sta. 00+036 A

Scope of Works:

- 1 General Requirements including billboard, construction safety & health, steel barricade (rental), and hauling of construction materials (manual).
- 2 Excavation for structures and shoring.
- 3 Construction of Reinforced Concrete Retaining Wall and Steel Fence.
- 4 All necessary testing and commissioning shall be performed in accordance to standards.

ITEM NO.	WORK DESCRIPTION AND SCOPE OF WORKS	QTY	UNIT	UNIT COST	AMOUNT
<b>I</b>	<b>GENERAL REQUIREMENTS</b>				
SPL7	Billboard	1	unit	P	P
SPL42	Hauling of Materials (manual)	42	days		
SPL12	Construction Safety and Health	1	unit		
SPL13a	Steel Barricade (rental)	2	unit		
				<b>DIRECT COST I</b>	<b>P</b>
<b>II</b>	<b>SITE WORKS</b>				
A.	Earthworks				
106c	Excavation (Solid Rock Adobe)	896	cu.m.	P	P
SPL33	Shoring	30	each		
				<b>DIRECT COST II</b>	<b>P</b>
<b>III</b>	<b>CIVIL / STRUCTURAL WORKS</b>				
A.	Construction of Slope Protection				
SPL 36b	Reinforced Concrete Retaining Wall (Ht. = 6.0 M)	36	l.m.	P	P

<b>I</b>	<b>GENERAL REQUIREMENTS</b>				
SPL7	Billboard	1	unit	P	P
SPL 53	Steel Fence with Steel Framing and Matting	36	l.m.		
				<b>DIRECT COST III</b>	<b>P</b>

<b>I</b>	<b>GENERAL REQUIREMENTS</b>														
SPL7	Billboard	1	unit	P	P										
NOTE: <ul style="list-style-type: none"> <li>Strictly enforce health protocols relative to latest applicable DPWH Memorandum.</li> </ul>		<table style="width: 100%; border-collapse: collapse;"> <tr> <td style="text-align: right;"><b>TOTAL DIRECT COST</b></td> <td style="text-align: right;"><b>P</b></td> </tr> <tr> <td style="text-align: right;">Overhead, Contingencies and Miscellaneous Expenses (OCM)</td> <td></td> </tr> <tr> <td style="text-align: right;">Profit</td> <td></td> </tr> <tr> <td style="text-align: right;">VAT</td> <td></td> </tr> <tr> <td style="text-align: right;"><b>TOTAL ESTIMATED COST</b></td> <td style="text-align: right;"><b>P</b></td> </tr> </table>				<b>TOTAL DIRECT COST</b>	<b>P</b>	Overhead, Contingencies and Miscellaneous Expenses (OCM)		Profit		VAT		<b>TOTAL ESTIMATED COST</b>	<b>P</b>
<b>TOTAL DIRECT COST</b>	<b>P</b>														
Overhead, Contingencies and Miscellaneous Expenses (OCM)															
Profit															
VAT															
<b>TOTAL ESTIMATED COST</b>	<b>P</b>														



## ***Section IX. Checklist of Technical and Financial Documents***

### **Notes on the Checklist of Technical and Financial Documents**

The prescribed documents in the checklist are mandatory to be submitted in the Bid, but shall be subject to the following:

- a. GPPB Resolution No. 09-2020 on the efficient procurement measures during a State of Calamity or other similar issuances that shall allow the use of alternate documents in lieu of the mandated requirements; or
- b. any subsequent GPPB issuances adjusting the documentary requirements after the effectivity of the adoption of the PBDs.

The BAC shall be checking the submitted documents of each Bidder against this checklist to ascertain if they are all present, using a non-discretionary “pass/fail” criterion pursuant to Section 30 of the 2016 revised IRR of RA No. 9184.

# Checklist of Technical and Financial Documents

## I. TECHNICAL COMPONENT ENVELOPE

### *Class “A” Documents*

#### Legal Documents

- (a) Valid PhilGEPS Registration Certificate (Platinum Membership) (all pages);  
**and**
- (b) Registration certificate from Securities and Exchange Commission (SEC), Department of Trade and Industry (DTI) for sole proprietorship, or Cooperative Development Authority (CDA) for cooperatives or its equivalent document;  
**and**
- (c) Mayor’s or Business permit issued by the city or municipality where the principal place of business of the prospective bidder is located, or the equivalent document for Exclusive Economic Zones or Areas;  
**and**
- (e) Tax clearance per E.O. No. 398, s. 2005, as finally reviewed and approved by the Bureau of Internal Revenue (BIR).

#### Technical Documents

- (f) Statement of the prospective bidder of all its ongoing government and private contracts, including contracts awarded but not yet started, if any, whether similar or not similar in nature and complexity to the contract to be bid (*please see attached prescribed forms required by the QC – BAC for Infrastructure and Consultancy*); **and**
- (g) Statement of the bidder’s Single Largest Completed Contract (SLCC) similar to the contract to be bid, except under conditions provided under the rules with an attached Notice of Award, Notice to Proceed, Contract and Certificate of Acceptance (*please see attached prescribed form required by the QC – BAC for Infrastructure and Consultancy*); **and**
- (h) Philippine Contractors Accreditation Board (PCAB) License;  
**or**  
Special PCAB License in case of Joint Ventures;  
**and** registration for the type and cost of the contract to be bid; **and**
- (i) Original copy of Bid Security. If in the form of a Surety Bond, submit also a certification issued by the Insurance Commission;  
**or**  
Original copy of Notarized Bid Securing Declaration; **and**
- (j) Project Requirements, which shall include the following:
  - a. Organizational chart for the contract to be bid;
  - b. List of contractor’s key personnel (*e.g.*, Project Manager, Project Engineers, Materials Engineers, and Foremen), to be assigned to the contract to be bid, with their complete qualification and experience data (*please see attached prescribed form required by the QC – BAC for Infrastructure and Consultancy*);
  - c. List of contractor’s major equipment units, which are owned, leased, and/or under purchase agreements, supported by proof of ownership or certification of availability of equipment from the equipment

lessor/vendor for the duration of the project, as the case may be (*please see attached prescribed form required by the QC – BAC for Infrastructure and Consultancy*); **and**

- (k) Original duly signed Omnibus Sworn Statement (OSS); **and** if applicable, Original Notarized Secretary's Certificate in case of a corporation, partnership, or cooperative; or Original Special Power of Attorney of all members of the joint venture giving full power and authority to its officer to sign the OSS and do acts to represent the Bidder.

Additional Technical Requirements:

- Certificate of Site Inspection or Affidavit of Site Inspection as part of Omnibus Sworn Statement
- Affidavit of Undertaking for Key Personnel and Equipment (*please see attached prescribed form required by the QC – BAC for Infrastructure and Consultancy*)
- Equipment Utilization Schedule
- Manpower Schedule
- Construction Schedule and S-Curve
- PERT-CMP
- Construction Methods

#### Financial Documents

- (l) The prospective bidder's audited financial statements, showing, among others, the prospective bidder's total and current assets and liabilities, stamped "received" by the BIR or its duly accredited and authorized institutions, for the preceding calendar year which should not be earlier than two (2) years from the date of bid submission; **and**
- (m) The prospective bidder's computation of Net Financial Contracting Capacity (NFCC) (*please see attached prescribed form required by the QC – BAC for Infrastructure and Consultancy*).

#### **Class "B" Documents**

- (n) If applicable, duly signed joint venture agreement (JVA) in accordance with RA No. 4566 and its IRR in case the joint venture is already in existence; **or** duly notarized statements from all the potential joint venture partners stating that they will enter into and abide by the provisions of the JVA in the instance that the bid is successful.

## **II. FINANCIAL COMPONENT ENVELOPE**

- (o) Original of duly signed and accomplished Financial Bid Form; **and**

#### Other documentary requirements under RA No. 9184

- (p) Original of duly signed Bid Prices in the Bill of Quantities; **and**
- (q) Duly accomplished Detailed Estimates Form, including a summary sheet indicating the unit prices of construction materials, labor rates, and equipment rentals used in coming up with the Bid; **and**
- (r) Cash Flow by Quarter.

**Bid Form for the Procurement of Infrastructure Projects**  
*[shall be submitted with the Bid]*

---

**BID FORM**

Date : \_\_\_\_\_  
Project Identification No. : \_\_\_\_\_

To: *[name and address of Procuring Entity]*

Having examined the Philippine Bidding Documents (PBDs) including the Supplemental or Bid Bulletin Numbers *[insert numbers]*, the receipt of which is hereby duly acknowledged, we, the undersigned, declare that:

- a. We have no reservation to the PBDs, including the Supplemental or Bid Bulletins, for the Procurement Project: *[insert name of contract]*;
- b. We offer to execute the Works for this Contract in accordance with the PBDs;
- c. The total price of our Bid in words and figures, excluding any discounts offered below is: *[insert information]*;
- d. The discounts offered and the methodology for their application are: *[insert information]*;
- e. The total bid price includes the cost of all taxes, such as, but not limited to: *[specify the applicable taxes, e.g. (i) value added tax (VAT), (ii) income tax, (iii) local taxes, and (iv) other fiscal levies and duties]*, which are itemized herein and reflected in the detailed estimates,
- f. Our Bid shall be valid within the a period stated in the PBDs, and it shall remain binding upon us at any time before the expiration of that period;
- g. If our Bid is accepted, we commit to obtain a Performance Security in the amount of *[insert percentage amount]* percent of the Contract Price for the due performance of the Contract, or a Performance Securing Declaration in lieu of the the allowable forms of Performance Security, subject to the terms and conditions of issued GPPB guidelines<sup>1</sup> for this purpose;
- h. We are not participating, as Bidders, in more than one Bid in this bidding process, other than alternative offers in accordance with the Bidding Documents;
- i. We understand that this Bid, together with your written acceptance thereof included in your notification of award, shall constitute a binding contract between us, until a formal Contract is prepared and executed; and
- j. We understand that you are not bound to accept the Lowest Calculated Bid or any other Bid that you may receive.

---

<sup>1</sup> currently based on GPPB Resolution No. 09-2020

- k. We likewise certify/confirm that the undersigned, is the duly authorized representative of the bidder, and granted full power and authority to do, execute and perform any and all acts necessary to participate, submit the bid, and to sign and execute the ensuing contract for the [Name of Project] of the [Name of the Procuring Entity].
- l. We acknowledge that failure to sign each and every page of this Bid Form, including the Bill of Quantities, shall be a ground for the rejection of our bid.

Name: \_\_\_\_\_

Legal Capacity: \_\_\_\_\_

Signature: \_\_\_\_\_

Duly authorized to sign the Bid for and behalf of: \_\_\_\_\_

Date: \_\_\_\_\_

## **Bid Securing Declaration Form**

*[shall be submitted with the Bid if bidder opts to provide this form of bid security]*

---

REPUBLIC OF THE PHILIPPINES)  
CITY OF \_\_\_\_\_) S.S.

### **BID SECURING DECLARATION** Project Identification No.: *[Insert number]*

To: *[Insert name and address of the Procuring Entity]*

I/We, the undersigned, declare that:

1. I/We understand that, according to your conditions, bids must be supported by a Bid Security, which may be in the form of a Bid Securing Declaration.
2. I/We accept that: (a) I/we will be automatically disqualified from bidding for any procurement contract with any procuring entity for a period of two (2) years upon receipt of your Blacklisting Order; and, (b) I/we will pay the applicable fine provided under Section 6 of the Guidelines on the Use of Bid Securing Declaration, within fifteen (15) days from receipt of the written demand by the procuring entity for the commission of acts resulting to the enforcement of the bid securing declaration under Sections 23.1(b), 34.2, 40.1 and 69.1, except 69.1(f), of the IRR of RA No. 9184; without prejudice to other legal action the government may undertake.
3. I/We understand that this Bid Securing Declaration shall cease to be valid on the following circumstances:
  - a. Upon expiration of the bid validity period, or any extension thereof pursuant to your request;
  - b. I am/we are declared ineligible or post-disqualified upon receipt of your notice to such effect, and (i) I/we failed to timely file a request for reconsideration or (ii) I/we filed a waiver to avail of said right; and
  - c. I am/we are declared the bidder with the Lowest Calculated Responsive Bid, and I/we have furnished the performance security and signed the Contract.

IN WITNESS WHEREOF, I/We have hereunto set my/our hand/s this \_\_\_\_ day of *[month]* *[year]* at *[place of execution]*.

*[Insert NAME OF BIDDER OR ITS AUTHORIZED  
REPRESENTATIVE]*  
*[Insert signatory's legal capacity]*  
Affiant

**[Jurat]**

*[Format shall be based on the latest Rules on Notarial Practice]*

## Omnibus Sworn Statement (Revised)

*[shall be submitted with the Bid]*

---

REPUBLIC OF THE PHILIPPINES )  
CITY/MUNICIPALITY OF \_\_\_\_\_ ) S.S.

### AFFIDAVIT

I, [Name of Affiant], of legal age, [Civil Status], [Nationality], and residing at [Address of Affiant], after having been duly sworn in accordance with law, do hereby depose and state that:

1. *[Select one, delete the other:]*

*[If a sole proprietorship:]* I am the sole proprietor or authorized representative of [Name of Bidder] with office address at [address of Bidder];

*[If a partnership, corporation, cooperative, or joint venture:]* I am the duly authorized and designated representative of [Name of Bidder] with office address at [address of Bidder];

2. *[Select one, delete the other:]*

*[If a sole proprietorship:]* As the owner and sole proprietor, or authorized representative of [Name of Bidder], I have full power and authority to do, execute and perform any and all acts necessary to participate, submit the bid, and to sign and execute the ensuing contract for [Name of the Project] of the [Name of the Procuring Entity], as shown in the attached duly notarized Special Power of Attorney;

*[If a partnership, corporation, cooperative, or joint venture:]* I am granted full power and authority to do, execute and perform any and all acts necessary to participate, submit the bid, and to sign and execute the ensuing contract for [Name of the Project] of the [Name of the Procuring Entity], as shown in the attached [state title of attached document showing proof of authorization (e.g., duly notarized Secretary's Certificate, Board/Partnership Resolution, or Special Power of Attorney, whichever is applicable)];

3. [Name of Bidder] is not "blacklisted" or barred from bidding by the Government of the Philippines or any of its agencies, offices, corporations, or Local Government Units, foreign government/foreign or international financing institution whose blacklisting rules have been recognized by the Government Procurement Policy Board, **by itself or by relation, membership, association, affiliation, or controlling interest with another blacklisted person or entity as defined and provided for in the Uniform Guidelines on Blacklisting;**

4. Each of the documents submitted in satisfaction of the bidding requirements is an authentic copy of the original, complete, and all statements and information provided therein are true and correct;

5. [Name of Bidder] is authorizing the Head of the Procuring Entity or its duly authorized representative(s) to verify all the documents submitted;

6. *[Select one, delete the rest:]*

*[If a sole proprietorship:]* The owner or sole proprietor is not related to the Head of the Procuring Entity, members of the Bids and Awards Committee (BAC), the Technical Working Group, and the BAC Secretariat, the head of the Project Management Office or the end-user unit, and the project consultants by consanguinity or affinity up to the third civil degree;

*[If a partnership or cooperative:]* None of the officers and members of [Name of Bidder] is related to the Head of the Procuring Entity, members of the Bids and Awards Committee (BAC), the Technical Working Group, and the BAC Secretariat, the head of the Project

Management Office or the end-user unit, and the project consultants by consanguinity or affinity up to the third civil degree;

*[If a corporation or joint venture:]* None of the officers, directors, and controlling stockholders of *[Name of Bidder]* is related to the Head of the Procuring Entity, members of the Bids and Awards Committee (BAC), the Technical Working Group, and the BAC Secretariat, the head of the Project Management Office or the end-user unit, and the project consultants by consanguinity or affinity up to the third civil degree;

7. *[Name of Bidder]* complies with existing labor laws and standards; and
8. *[Name of Bidder]* is aware of and has undertaken the responsibilities as a Bidder in compliance with the Philippine Bidding Documents, which includes:
  - a. Carefully examining all of the Bidding Documents;
  - b. Acknowledging all conditions, local or otherwise, affecting the implementation of the Contract;
  - c. Making an estimate of the facilities available and needed for the contract to be bid, if any; and
  - d. Inquiring or securing Supplemental/Bid Bulletin(s) issued for the *[Name of the Project]*.
9. *[Name of Bidder]* did not give or pay directly or indirectly, any commission, amount, fee, or any form of consideration, pecuniary or otherwise, to any person or official, personnel or representative of the government in relation to any procurement project or activity.
10. **In case advance payment was made or given, failure to perform or deliver any of the obligations and undertakings in the contract shall be sufficient grounds to constitute criminal liability for Swindling (Estafa) or the commission of fraud with unfaithfulness or abuse of confidence through misappropriating or converting any payment received by a person or entity under an obligation involving the duty to deliver certain goods or services, to the prejudice of the public and the government of the Philippines pursuant to Article 315 of Act No. 3815 s. 1930, as amended, or the Revised Penal Code.**
11. We pledge that the project will be completed in accordance and congruency with the approved plans and programs.

**IN WITNESS WHEREOF**, I have hereunto set my hand this \_\_\_ day of \_\_\_\_\_ 20\_ at \_\_\_\_\_, Philippines.

*[Insert NAME OF BIDDER OR ITS AUTHORIZED REPRESENTATIVE]*

*[Insert signatory's legal capacity]*

Affiant

**[Jurat]**

*[Format shall be based on the latest Rules on Notarial Practice]*



## Contract Agreement Form for the Procurement of Infrastructure Projects (Revised)

*[not required to be submitted with the Bid, but it shall be submitted within ten (10) days after receiving the Notice of Award]*

---

### CONTRACT AGREEMENT

THIS AGREEMENT, made this *[insert date]* day of *[insert month]*, *[insert year]* between *[name and address of PROCURING ENTITY]* (hereinafter called the "Entity") and *[name and address of Contractor]* (hereinafter called the "Contractor").

WHEREAS, the Entity is desirous that the Contractor execute *[name and identification number of contract]* (hereinafter called "the Works") and the Entity has accepted the Bid for *[contract price in words and figures in specified currency]* by the Contractor for the execution and completion of such Works and the remedying of any defects therein.

NOW THIS AGREEMENT WITNESSETH AS FOLLOWS:

1. In this Agreement, words and expressions shall have the same meanings as are respectively assigned to them in the Conditions of Contract hereinafter referred to.
2. The following documents as required by the 2016 revised Implementing Rules and Regulations of Republic Act No. 9184 shall be deemed to form and be read and construed as part of this Agreement, *viz.*:
  - a. Philippine Bidding Documents (PBDs);
    - i. Drawings/Plans;
    - ii. Specifications;
    - iii. Bill of Quantities;
    - iv. General and Special Conditions of Contract;
    - v. Supplemental or Bid Bulletins, if any;
  - b. Winning bidder's bid, including the Eligibility requirements, Technical and Financial Proposals, and all other documents or statements submitted;  
  
Bid form, including all the documents/statements contained in the Bidder's bidding envelopes, as annexes, and all other documents submitted (*e.g.*, Bidder's response to request for clarifications on the bid), including corrections to the bid, if any, resulting from the Procuring Entity's bid evaluation;
  - c. Performance Security;
  - d. Notice of Award of Contract and the Bidder's conforme thereto; and
  - e. Other contract documents that may be required by existing laws and/or the Procuring Entity concerned in the PBDs. **Winning bidder agrees that additional contract documents or information prescribed by the GPPB that are subsequently required for submission after the contract execution, such as the Notice to Proceed, Variation Orders, and Warranty Security, shall likewise form part of the Contract.**
3. In consideration for the sum of *[total contract price in words and figures]* or such other sums as may be ascertained, *[Named of the bidder]* agrees to *[state the object of the contract]* in accordance with his/her/its Bid.

4. The *[Name of the procuring entity]* agrees to pay the above-mentioned sum in accordance with the terms of the Bidding.

IN WITNESS whereof the parties thereto have caused this Agreement to be executed the day and year first before written.

*[Insert Name and Signature] [Insert Name and Signature]*

*[Insert Signatory's Legal Capacity] [Insert Signatory's Legal Capacity]*

*for: for:*

*[Insert Procuring Entity] [Insert Name of Supplier]*

**Acknowledgment**

*[Format shall be based on the latest Rules on Notarial Practice]*

## Performance Securing Declaration (Revised)

*[if used as an alternative performance security but it is not required to be submitted with the Bid, as it shall be submitted within ten (10) days after receiving the Notice of Award]*

---

REPUBLIC OF THE PHILIPPINES)  
CITY OF \_\_\_\_\_ ) S.S.

### PERFORMANCE SECURING DECLARATION

Invitation to Bid: [Insert Reference Number indicated in the Bidding Documents] To:  
[Insert name and address of the Procuring Entity]

I/We, the undersigned, declare that:

1. I/We understand that, according to your conditions, to guarantee the faithful performance by the supplier/distributor/manufacture/contractor/consultant of its obligations under the Contract, I/we shall submit a Performance Securing Declaration within a maximum period of ten (10) calendar days from the receipt of the Notice of Award prior to the signing of the Contract.
2. I/We accept that: I/we will be automatically disqualified from bidding for any procurement contract with any procuring entity for a period of one (1) year for the first offense, or two (2) years **for the second offense**, upon receipt of your Blacklisting Order if I/We have violated my/our obligations under the Contract;
3. I/We understand that this Performance Securing Declaration shall cease to be valid upon:
  - a. issuance by the Procuring Entity of the Certificate of Final Acceptance, subject to the following conditions:
    - i. Procuring Entity has no claims filed against the contract awardee;
    - ii. It has no claims for labor and materials filed against the contractor; and
    - iii. Other terms of the contract; or
  - b. replacement by the winning bidder of the submitted PSD with a performance security in any of the prescribed forms under Section 39.2 of the 2016 revised IRR of RA No. 9184 as required by the end-user.

**IN WITNESS WHEREOF**, I/We have hereunto set my/our hand/s this \_\_\_\_ day of [month] [year] at [place of execution].

*[Insert NAME OF BIDDER OR ITS  
AUTHORIZED REPRESENTATIVE]  
[Insert signatory's legal capacity]  
Affiant*

**[Jurat]**

*[Format shall be based on the latest Rules on Notarial Practice]*

LIST OF ALL ON-GOING GOVERNMENT AND PRIVATE CONTRACTS

NAME OF CONTRACTOR: \_\_\_\_\_

PROJECT TITLE (Name of the Contract) & EXACT PROJECT LOCATION	DATE OF CONTRACT	CONTRACT DURATION	PROJECT OWNER & POSTAL ADDRESS	NATURE OF WORK	CONTRACTOR'S ROLE (SOLE CONTRACTOR, SUBCONTRACTOR, PARTNER IN A JV) and PERCENTAGE OF PARTICIPATION	TOTAL CONTRACT VALUE AT AWARD	DATE OF COMPLETION or ESTIMATED COMPLETION TIME	TOTAL CONTRACT VALUE AT COMPLETION IF APPLICABLE	PERCENTAGE		VALUE OF OUTSTANDING WORKS (IN PHP)
									ACTUAL ACCOMPLISHMENT	PLANNED ACCOMPLISHMENT	
									TOTAL AMOUNT (Php) OF OUTSTANDING WORKS		

PHOTOCOPY ADDITIONAL FORMS, IF NECESSARY

**LIST OF ALL AWARDED BUT NOT YET STARTED GOVERNMENT AND PRIVATE CONTRACTS OF THE BIDDER**

**NAME OF CONTRACTOR:** \_\_\_\_\_

**PROJECT TITLE:** \_\_\_\_\_

PROJECT TITLE & EXACT LOCATION	MAJOR SCOPE OF WORKS & DATE STARTED	NAME AND ADDRESS OF PROJECT OWNER	CONTRACT PRICE (PHP) AS AWARDED	DATE OF SCHEDULED COMPLETION	ROLE OF BIDDER <u>IN THE CONTRACT SOLE CONTRACTOR / SUB-CONTRACTOR/PARTNER IN A</u>
	TOTAL AMOUNT OF CONTRACT (Php)				

**SINGLE LARGEST COMPLETED CONTRACT SIMILAR TO THE CONTRACT TO BE BID**

**NAME OF CONTRACTOR:** \_\_\_\_\_

**PROJECT TITLE:** \_\_\_\_\_

PROJECT TITLE (Name of the Contract) & EXACT PROJECT LOCATION	DATE OF CONTRACT	CONTRACT DURATION	PROJECT OWNER & POSTAL ADDRESS	NATURE OF WORK	CONTRACTOR'S ROLE (SOLE CONTRACTOR, SUBCONTRACTOR, PARTNER IN A JV) and PERCENTAGE OF PARTICIPATION	TOTAL CONTRACT VALUE AT AWARD	DATE OF COMPLETION or ESTIMATED COMPLETION TIME	TOTAL CONTRACT VALUE AT COMPLETION IF APPLICABLE

**LIST OF MAJOR EQUIPMENT TO BE USED FOR THE PROJECT**

**NAME OF CONTRACTOR:** \_\_\_\_\_

**PROJECT TITLE:** \_\_\_\_\_

TYPE	DESCRIPTION / CAPACITY	SERIAL NO.	YEAR ACQUIRED	PRESENT LOCATION (SPECIFIC ADDRESS)	STATUS OF AVAILABILITY (OWNED/LEASED)

**A. LIST OF KEY CONSTRUCTION PERSONNEL TO BE ASSIGNED TO THE PROJECT**

**NAME OF CONTRACTOR:** \_\_\_\_\_

**PROJECT TITLE:** \_\_\_\_\_

NAME	POSITION	AGE	EDUCATIONAL ATTAINMENT	TYPE OF CONSTRUCTION EXPERIENCE	NO.OF YEARS WITH THE CONTRACTOR	PROFESSION	PRC NO.



## COMPUTATION OF NET FINANCIAL CONTRACTING CAPACITY (NFCC)

NAME OF BIDDER: \_\_\_\_\_

CURRENT ASSETS*		PHP	_____
(LESS) CURRENT LIABILITIES*	(LESS)	PHP	_____
NETWORTH		PHP	_____
NETWORTH x 15	x 15	PHP	_____
(LESS) VALUE OF ALL OUTSTANDING ON-GOING CONTRACTS**	(LESS)	PHP	_____
(LESS) VALUE OF ALL AWARDED BUT NOT YET STARTED CONTRACTS AS OF DATE**	(LESS)	PHP	_____
<b>NET FINANCIAL CONTRACTING CAPACITY</b>		PHP	_____

NOTES: \* CURRENT ASSETS AND LIABILITIES BASED ON AUDITED FINANCIAL STATEMENT FOR THE PRECEDING CALENDAR YEAR SUBMITTED TO B.I.R.

\*\* BASED ON LIST OF ON-GOING AND AWRDED BUT NOT YEY STARTED CONTRACTS SUBMITTED

REPUBLIC OF THE PHILIPPINES)

\_\_\_\_\_ ) S. S.

**AFFIDAVIT OF UNDERTAKING**

I, \_\_\_\_\_, of legal age, Filipino, \_\_\_\_\_ **[OFFICER OR REPRESENTATIVE]**

with office address at \_\_\_\_\_ after having been duly sworn to in accordance with law, hereby voluntary depose and state:

That I am duly authorized representative of the **[Name of Bidder]** to execute this undertaking as evidenced by Secretary's Certificate and Board Resolution.

That **[Name of Bidder]** bidding for the (Name of Project)

That relative to the aforementioned Project, the **[Name of Bidder]** hereby undertake that the equipment to be use and the key personnel to be assign shall exclusively be used and will only perform to the said project until its completion.

That I am executing this affidavit to attest to the truth of the foregoing and in compliance with the submission of the technical requirements for the public bidding of the said project.

IN WITNESS HEREOF, I have hereunto signed my name below this \_\_\_\_\_ day of \_\_\_\_\_ at \_\_\_\_\_.

AFFIANT FURTHER SAYETH NAUGHT.

\_\_\_\_\_

Affiant

**SUBSCRIBED AND SWORN TO BEFORE ME** this \_\_\_ day of \_\_\_\_\_  
\_\_\_\_\_ in \_\_\_\_\_

affiant exhibiting to me his/her \_\_\_\_\_ issued at \_\_\_\_\_ on \_\_\_\_\_.

Doc. No. ;  
Page No. ;  
Book No. ;  
Series of 2020

\_\_\_\_\_

Notary Public

